

Surface Mount Multilayer Ceramic Capacitors

Commercial Grade

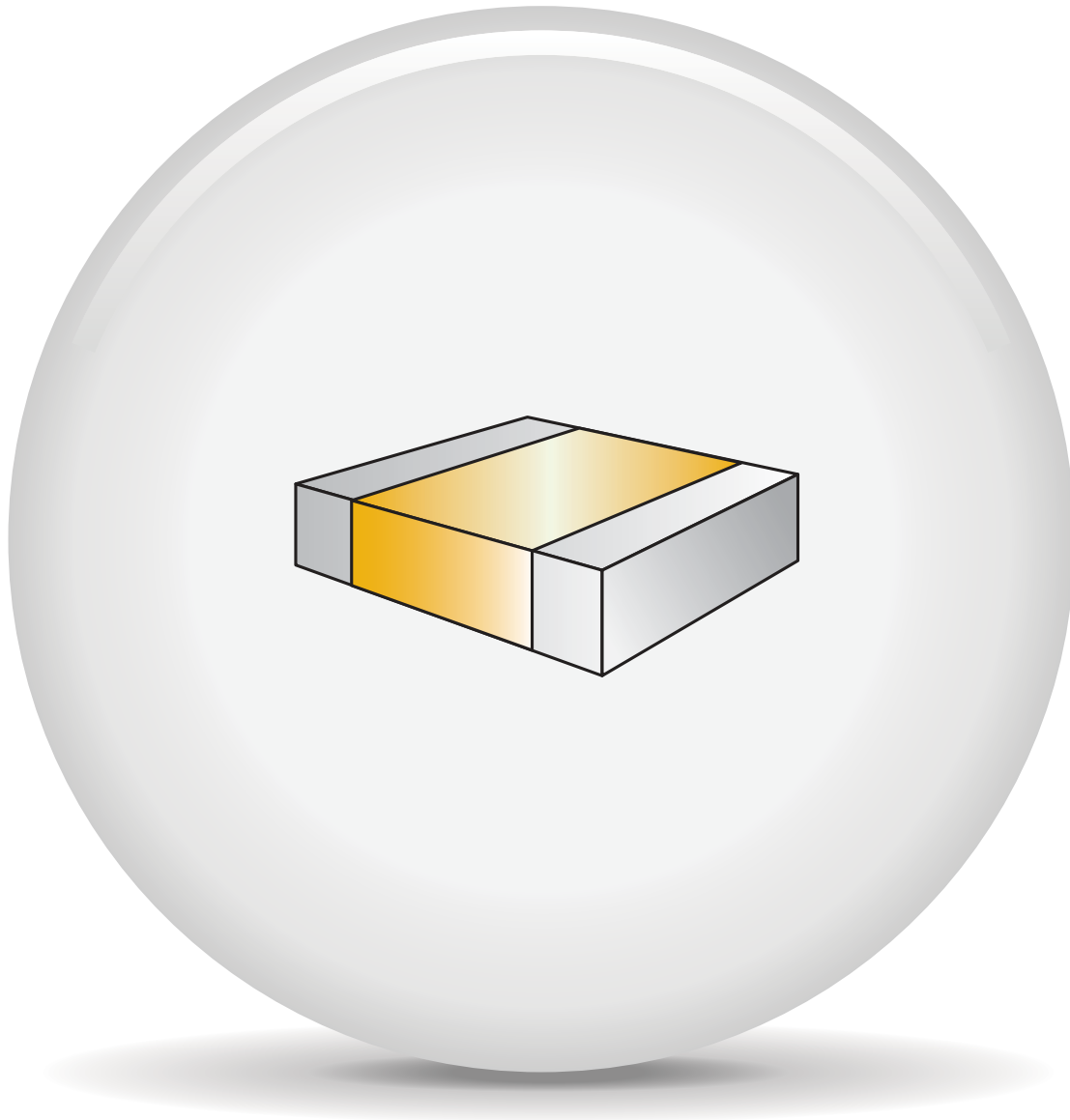

One world. One KEMET.

Electronic Components
KEMET
CHARGED.®

Table of Contents Page

Why Choose KEMET	4
-------------------------------	----------

Standard Products

C0G Dielectric, 10 – 200 VDC	6
X7R Dielectric, 6.3 – 250 VDC	16
X5R Dielectric, 4 – 50 VDC	28
Z5U Dielectric, 50 – 100 VDC	37
Y5V Dielectric, 6.3 – 50 VDC	45
Capacitor Array, C0G Dielectric, 10 – 200 VDC	53
Capacitor Array, X7R Dielectric, 10 – 200 VDC	60
Commercial Off-the-Shelf (COTS) for Higher Reliability Applications, C0G Dielectric, 10 – 200 VDC	67
Commercial Off-the-Shelf (COTS) for Higher Reliability Applications, X7R Dielectric, 6.3 – 200 VDC	76
Telecom “Tip and Ring” X7R Dielectric, 250 VDC	87

Flex Mitigation Solutions

Open Mode Design (FO-CAP), X7R Dielectric, 16 – 200 VDC	96
Floating Electrode Design (FE-CAP) X7R Dielectric, 6.3 – 250 VDC	105
Flexible Termination System (FT-CAP) C0G Dielectric, 10 – 200 VDC	114
Flexible Termination System (FT-CAP) X7R Dielectric, 6.3 – 250 VDC	123
High Voltage with Flexible Termination System (HV FT-CAP) X7R Dielectric, 500 – 3,000 VDC	133
Flexible Termination System (FT-CAP), Ultra-Stable X8R Dielectric, 25 – 100 VDC (Commercial & Automotive Grade)	143
Floating Electrode Design with Flexible Termination System (FF-CAP) X7R Dielectric, 6.3 – 250 VDC	151
KPS Series, X7R Dielectric, 10 – 250 VDC	160
KPS Series, High Voltage, X7R Dielectric, 500 – 630 VDC	171
KPS HT Series, High Temperature 150°C, X8L Dielectric, 10 VDC – 50 VDC	178

SnPb End Metallization

Commercial “L” Series, SnPb Termination, C0G Dielectric, 10 – 200 VDC	185
Commercial “L” Series, SnPb Termination, X7R Dielectric, 6.3 – 250 VDC	195
Commercial Off-the-Shelf (COTS) for Higher Reliability Applications, C0G Dielectric, 10 – 200 VDC	205
Commercial Off-the-Shelf (COTS) for Higher Reliability Applications, X7R Dielectric, 6.3 – 200 VDC	214
High Temperature 150°C, Ultra Stable X8R Dielectric, 25 – 100 VDC	225
High Temperature 150°C, X8L Dielectric, 10 – 50 VDC	233
Telecom “Tip and Ring,” X7R Dielectric, 250 VDC	242
Open Mode Design (FO-CAP), X7R Dielectric, 16 – 200 VDC	250
Floating Electrode Design (FE-CAP) X7R Dielectric, 6.3 – 250 VDC	259
Flexible Termination System (FT-CAP) X7R Dielectric, 6.3 – 250 VDC	268
Floating Electrode Design with Flexible Termination System (FF-CAP) X7R Dielectric, 6.3 – 250 VDC	278

Bulk Capacitance Solutions (Stacked Capacitors)

KPS Series, X7R Dielectric, 10 – 250 VDC.....	287
KPS Series, High Voltage, X7R Dielectric, 500 – 630 VDC.....	298
KPS HT Series, High Temperature 150°C, X8L Dielectric, 10 VDC – 50 VDC.....	305
KEMET Power Solutions (KPS) MIL Series, Stacked Capacitors, 50 – 500 VDC.....	312

High Temperature

High Temperature 150°C, Ultra Stable X8R Dielectric, 25 – 100 VDC.....	335
High Temperature 150°C, X8L Dielectric, 10 – 50 VDC.....	343
High Temperature 200°C, C0G Dielectric, 10 – 200 VDC.....	352
Flexible Termination System (FT-CAP), Ultra-Stable X8R Dielectric, 25 – 100 VDC (Commercial & Automotive Grade).....	361
KPS HT Series, High Temperature 150°C, X8L Dielectric, 10 VDC – 50 VDC.....	369
Pulse Detonation, High Voltage, High Temperature 200°C, C0G Dielectric, 500 – 2,000 VDC (Industrial Grade).....	376

High Voltage

High Voltage C0G Dielectric, 500 – 3,000 VDC.....	383
High Voltage X7R Dielectric, 500 – 3,000 VDC.....	393
High Voltage with Flexible Termination System (HV FT-CAP), X7R Dielectric, 500 – 3,000 VDC.....	404
ArcShield™ Technology, High Voltage, X7R Dielectric, 500 – 1,000 VDC (Commercial & Automotive Grade).....	414
KPS Series, High Voltage, X7R Dielectric, 500 – 630 VDC.....	423
KPS HV, Large Case, SM Series, C0G Dielectric, 500 – 10,000 VDC (Industrial Grade).....	430
KPS HV, Large Case, SM Series, X7R Dielectric, 500 – 10,000 VDC (Industrial Grade).....	440
Pulse Detonation, High Voltage, High Temperature 200°C, C0G Dielectric, 500 – 2,000 VDC (Industrial Grade).....	451

Marking Information

Marking for X7R, COTS (X7R), SnPb (X7R), Tip & Ring (X7R), Open Mode (X7R), FE-CAP (X7R), FT-CAP (X7R), FF-CAP (X7R), HV X7R, HV FT-CAP (X7R), HV X7R ARC SHIELD, X5R, AUTO (X5R), Z5U, X8L, Array X7R, KPS (X7R), and KPS HV (X7R).....	458
--	-----

Marking Information for C0G, 200°C C0G, COTS (C0G), SnPb (C0G), HV C0G, FT-CAP (C0G), FT-CAP (X8R), Y5V, X8R, HV/HT PULSE DETONATION (C0G), and Array C0G is included within the appropriate product sections.

Packaging Information.....	459
-----------------------------------	------------

KPS Packaging Information	465
--	------------

KEMET Corporation Sales Offices	470
--	------------

Other KEMET Resources	471
------------------------------------	------------

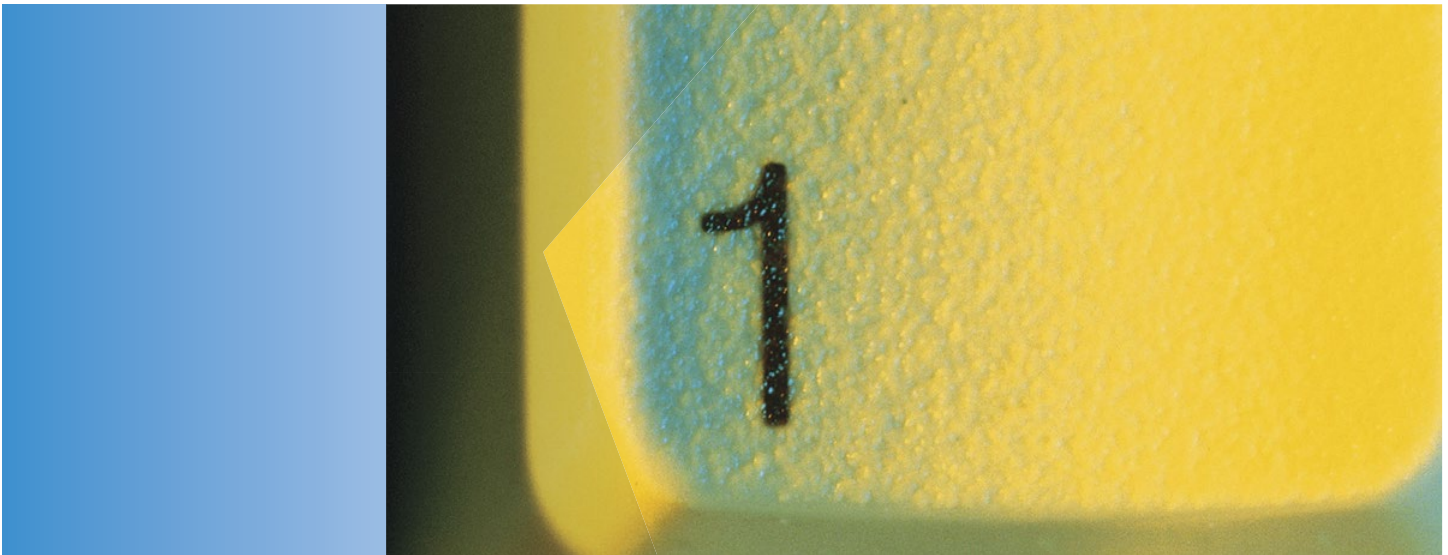

One world. One source. One KEMET.

When you partner with KEMET, our entire global organization provides you with the coordinated service you need. No bouncing from supplier to supplier. No endless phone calls and web browsing. We're your single, integrated source for electronic component solutions worldwide.

Less hassles. More solutions.

Our commitment to product quality and on-time delivery has helped customers succeed for over 90 years. There's a reason KEMET components can be found in defense and aerospace equipment. Our reputation is built on a history of consistency, reliability and service.

The "Easy-to-Buy-From" company.

KEMET offers a level of responsiveness that far surpasses any other supplier. Our passion for customer service is evident throughout our global sales organization, which offers localized support bolstered by our worldwide logistics capabilities. Whether you need rush samples, technical assistance, in-person consultation, accelerated custom design, design collaboration or prototype services, we have a solution.



Made for you.

When you need custom products delivered on a tight schedule, you can trust KEMET. Get direct design consultation from global experts, who help you get the job done on time and within budget.

Working for a better world.

KEMET is dedicated to economically, environmentally and socially sustainable development. We've adopted the Electronic Industry Code of Conduct (EICC) to address all aspects of corporate responsibility. Our manufacturing facilities have won numerous environmental excellence awards and recognitions, and our supply chain is certified. We believe doing the right thing is in everyone's interest.

About KEMET.

KEMET Corporation is a leading global supplier of electronic components. We offer our customers the broadest selection of capacitor technologies in the industry across multiple dielectrics, along with an expanding range of electromechanical devices, and electromagnetic compatibility solutions. Our vision is to be the preferred supplier of electronic component solutions for customers demanding the highest standards of quality, delivery and service.

Surface Mount Multilayer Ceramic Chip Capacitors (SMD MLCCs)

C0G Dielectric, 10 – 200 VDC (Commercial Grade)

Overview

KEMET's C0G dielectric features a 125°C maximum operating temperature and is considered "stable." The Electronics Components, Assemblies & Materials Association (EIA) characterizes C0G dielectric as a Class I material. Components of this classification are temperature compensating and are suited for resonant circuit applications or those where Q and

stability of capacitance characteristics are required. C0G exhibits no change in capacitance with respect to time and voltage and boasts a negligible change in capacitance with reference to ambient temperature. Capacitance change is limited to ± 30 ppm/°C from -55°C to +125°C.

Benefits

- -55°C to +125°C operating temperature range
- RoHS Compliant
- EIA 0201, 0402, 0603, 0805, 1206, 1210, 1808, 1812, 1825, 2220, and 2225 case sizes
- DC voltage ratings of 10 V, 16 V, 25 V, 50 V, 100 V, and 200 V
- Capacitance offerings ranging from 0.5 pF up to 0.47 μ F
- Available capacitance tolerances of ± 0.10 pF, ± 0.25 pF, ± 0.5 pF, $\pm 1\%$, $\pm 2\%$, $\pm 5\%$, $\pm 10\%$, and $\pm 20\%$
- No piezoelectric noise
- Extremely low ESR and ESL
- High thermal stability
- High ripple current capability
- Preferred capacitance solution at line frequencies and into the MHz range
- No capacitance change with respect to applied rated DC voltage
- Negligible capacitance change with respect to temperature from -55°C to +125°C
- No capacitance decay with time
- Non-polar device, minimizing installation concerns
- 100% pure matte tin-plated termination finish allowing for excellent solderability
- SnPb plated termination finish option available upon request (5% minimum)

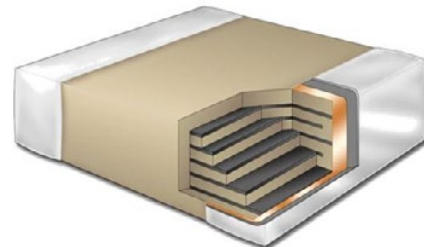

Ordering Information

C	1206	C	104	J	3	G	A	C	TU
Ceramic	Case Size (L" x W")	Specification/ Series ¹	Capacitance Code (pF)	Capacitance Tolerance ²	Voltage	Dielectric	Failure Rate/ Design	Termination Finish ³	Packaging/Grade (C-Spec) ⁴
	0201 0402 0603 0805 1206 1210 1808 1812 1825 2220 2225	C = Standard	2 significant digits + number of zeros. Use 9 for 1.0 – 9.9 pF Use 8 for 0.5 – .99 pF e.g., 2.2 pF = 229 e.g., 0.5 pF = 508	B = ± 0.10 pF C = ± 0.25 pF D = ± 0.5 pF F = $\pm 1\%$ G = $\pm 2\%$ J = $\pm 5\%$ K = $\pm 10\%$ M = $\pm 20\%$	8 = 10 V 4 = 16 V 3 = 25 V 5 = 50 V 1 = 100 V 2 = 200 V	G = C0G	A = N/A	C = 100% Matte Sn	Blank = Bulk TU = 7" Reel Unmarked

¹ Flexible termination option is available. Please see FT-CAP product bulletin C1062_C0G_FT-CAP_SMD

² Additional capacitance tolerance offerings may be available. Contact KEMET for details.

³ Additional termination finish options may be available. Contact KEMET for details.

⁴ Additional reeling or packaging options may be available. Contact KEMET for details.

Dimensions – Millimeters (Inches)

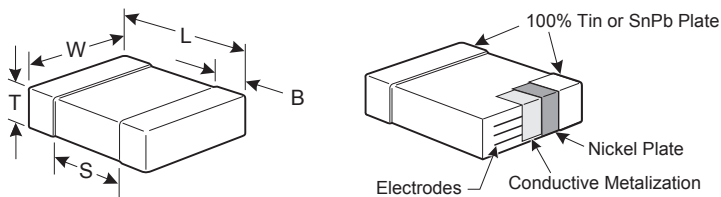

EIA Size Code	Metric Size Code	L Length	W Width	T Thickness	B Bandwidth	S Separation Minimum	Mounting Technique
0201	0603	0.60 (.024) ± 0.03 (.001)	0.30 (.012) ± 0.03 (.001)	See Table 2 for Thickness	0.15 (.006) ± 0.05 (.002)	N/A	Solder Reflow Only
0402	1005	1.00 (.040) ± 0.05 (.002)	0.50 (.020) ± 0.05 (.002)		0.30 (.012) ± 0.10 (.004)	0.30 (.012)	
0603	1608	1.60 (.063) ± 0.15 (.006)	0.80 (.032) ± 0.15 (.006)		0.35 (.014) ± 0.15 (.006)	0.70 (.028)	Solder Wave or Solder Reflow
0805	2012	2.00 (.079) ± 0.20 (.008)	1.25 (.049) ± 0.20 (.008)		0.50 (0.02) ± 0.25 (.010)	0.75 (.030)	
1206	3216	3.20 (.126) ± 0.20 (.008)	1.60 (.063) ± 0.20 (.008)		0.50 (0.02) ± 0.25 (.010)	N/A	Solder Reflow Only
1210	3225	3.20 (.126) ± 0.20 (.008)	2.50 (.098) ± 0.20 (.008)		0.50 (0.02) ± 0.25 (.010)		
1808	4520	4.70 (.185) ± 0.50 (.020)	2.00 (.079) ± 0.20 (.008)		0.60 (.024) ± 0.35 (.014)		
1812	4532	4.50 (.177) ± 0.30 (.012)	3.20 (.126) ± 0.30 (.012)		0.60 (.024) ± 0.35 (.014)		
1825	4564	4.50 (.177) ± 0.30 (.012)	6.40 (.252) ± 0.40 (.016)		0.60 (.024) ± 0.35 (.014)		
2220	5650	5.70 (.224) ± 0.40 (.016)	5.00 (.197) ± 0.40 (.016)		0.60 (.024) ± 0.35 (.014)		
2225	5664	5.60 (.220) ± 0.40 (.016)	6.40 (.248) ± 0.40 (.016)		0.60 (.024) ± 0.35 (.014)		

Applications

Typical applications include critical timing, tuning, circuits requiring low loss, circuits with pulse, high current, decoupling, bypass, filtering, transient voltage suppression, blocking and energy storage.

Qualification/Certification

Commercial Grade products are subject to internal qualification. Details regarding test methods and conditions are referenced in Table 4, Performance and Reliability.

Environmental Compliance

RoHS Compliant.



RoHS Compliant

Electrical Parameters/Characteristics

Item	Parameters/Characteristics
Operating Temperature Range	-55°C to +125°C
Capacitance Change with Reference to +25°C and 0 VDC Applied (TCC)	±30 ppm/°C
Aging Rate (Maximum % Capacitance Loss/Decade Hour)	0%
Dielectric Withstanding Voltage (DWV)	250% of rated voltage (5 ± 1 seconds and charge/discharge not exceeding 50 mA)
Dissipation Factor (DF) Maximum Limit @ 25°C	0.1%
Insulation Resistance (IR) Limit @ 25°C	1,000 megohm microfarads or 100 GΩ (Rated voltage applied for 120 ± 5 seconds @ 25°C)

To obtain IR limit, divide MΩ-μF value by the capacitance and compare to GΩ limit. Select the lower of the two limits.

Capacitance and Dissipation Factor (DF) measured under the following conditions:

1 MHz ± 100 kHz and 1.0 Vrms ± 0.2 V if capacitance ≤ 1,000 pF

1 kHz ± 50 Hz and 1.0 Vrms ± 0.2 V if capacitance > 1,000 pF

Note: When measuring capacitance it is important to ensure the set voltage level is held constant. The HP4284 and Agilent E4980 have a feature known as Automatic Level Control (ALC). The ALC feature should be switched to "ON."

Post Environmental Limits

High Temperature Life, Biased Humidity, Moisture Resistance					
Dielectric	Rated DC Voltage	Capacitance Value	Dissipation Factor (Maximum %)	Capacitance Shift	Insulation Resistance
COG	All	All	0.5	0.3% or ±0.25 pF	10% of Initial Limit

Table 1A – Capacitance Range/Selection Waterfall (0201 – 1206 Case Sizes) cont'd

Capacitance	Cap Code	Case Size / Series	C0201C			C0402C					C0603C						C0805C						C1206C								
			Voltage Code			8	4	3	8	4	3	5	1	2	8	4	3	5	1	2	8	4	3	5	1	2	8	4	3	5	1
		Rated Voltage (VDC)			10	16	25	10	16	25	50	100	200	10	16	25	50	100	200	10	16	25	50	100	200	10	16	25	50	100	200
		Capacitance Tolerance			Product Availability and Chip Thickness Codes See Table 2 for Chip Thickness Dimensions																										
2,700 pF	272	F G J K M										CB	CB	CB	CB	CB	DC	DC	DC	DC	DC	DC	EB	EB	EB	EB	EC	EC			
3,000 pF	302	F G J K M										CB	CB	CB	CB	CB	DD	DD	DD	DD	DC	DC	EC	EC	EC	EC	EC	EB			
3,300 pF	332	F G J K M										CB	CB	CB	CB	CB	DD	DD	DD	DD	DC	DC	EC	EC	EC	EC	EE	EB			
3,600 pF	362	F G J K M										CB	CB	CB	CB	CB	DD	DD	DD	DD	DC	DD	EC	EC	EC	EC	EE	EB			
3,900 pF	392	F G J K M										CB	CB	CB	CB	CB	DE	DE	DE	DE	DC	DD	EC	EC	EC	EC	EF	EB			
4,300 pF	432	F G J K M										CB	CB	CB	CB	CB	DE	DE	DE	DE	DC	DD	EC	EC	EC	EC	EC	EB			
4,700 pF	472	F G J K M										CB	CB	CB	CB	CB	DE	DE	DE	DE	DC	DD	EC	EC	EC	EC	EC	EB			
5,100 pF	512	F G J K M										CB	CB	CB	CB	CB	DE	DE	DE	DE	DC	DD	ED	ED	ED	ED	ED	EB			
5,600 pF	562	F G J K M										CB	CB	CB	CB	CB	DC	DC	DC	DC	DC	DD	ED	ED	ED	ED	ED	EB			
6,200 pF	622	F G J K M										CB	CB	CB	CB	CB	DC	DC	DC	DC	DC	DG	EB	EB	EB	EB	EB	EB			
6,800 pF	682	F G J K M										CB	CB	CB	CB	CB	DC	DC	DC	DC	DC	DG	EB	EB	EB	EB	EB	EB			
7,500 pF	752	F G J K M										CB	CB	CB	CB	CB	DC	DC	DC	DC	DC	DG	EB	EB	EB	EB	EB	EB			
8,200 pF	822	F G J K M										CB	CB	CB	CB	CB	DC	DC	DC	DC	DC	DG	EC	EC	EC	EC	EB	EC			
9,100 pF	912	F G J K M										CB	CB	CB	CB	CB	DC	DC	DC	DC	DC	DG	EC	EC	EC	EC	EB	EC			
10,000 pF	103	F G J K M										CB	CB	CB	CB	CB	DC	DC	DC	DC	DC	DD	ED	ED	ED	ED	EB	EC			
12,000 pF	123	F G J K M										CB	CB	CB	CB	CB	DC	DC	DC	DC	DC	DE	EB	EB	EB	EB	EB	ED			
15,000 pF	153	F G J K M										CB	CB	CB	CB	CB	DC	DC	DC	DC	DC	DG	EB	EB	EB	EB	EB	EF			
18,000 pF	183	F G J K M										CB	CB	CB	CB	CB	DC	DC	DC	DC	DC	DD	EB	EB	EB	EB	EB	EH			
22,000 pF	223	F G J K M										CB	CB	CB	CB	CB	DD	DD	DD	DD	DF	DF	EB	EB	EB	EB	EC	EH			
27,000 pF	273	F G J K M										CB	CB	CB	CB	CB	DF	DF	DF	DF	DF	DF	EB	EB	EB	EB	EE	EB			
33,000 pF	333	F G J K M										CB	CB	CB	CB	CB	DG	DG	DG	DG	DG	DG	EB	EB	EB	EB	EE	EB			
39,000 pF	393	F G J K M										CB	CB	CB	CB	CB	DG	DG	DG	DG	DG	DG	EC	EC	EC	EE	EH	EB			
47,000 pF	473	F G J K M										CB	CB	CB	CB	CB	DG	DG	DG	DG	DG	DG	EC	EC	EC	EE	EH	EB			
56,000 pF	563	F G J K M										CB	CB	CB	CB	CB							ED	ED	ED	EF	EB	EB			
68,000 pF	683	F G J K M										CB	CB	CB	CB	CB							EF	EF	EF	EH	EB	EB			
82,000 pF	823	F G J K M										CB	CB	CB	CB	CB							EH	EH	EH	EH	EB	EB			
0.10 µF	104	F G J K M										CB	CB	CB	CB	CB							EH	EH	EH	EH	EB	EB			
Capacitance	Cap Code	Rated Voltage (VDC)			C0201C			C0402C					C0603C						C0805C						C1206C						
		Voltage Code			8	4	3	8	4	3	5	1	2	8	4	3	5	1	2	8	4	3	5	1	2	8	4	3	5	1	2
		Case Size / Series			C0201C			C0402C					C0603C						C0805C						C1206C						

*Capacitance range Includes E24 decade values only. (i.e., 10, 11, 12, 13, 15, 16, 18, 20, 22, 24, 27, 30, 33, 36, 39, 43, 47, 51, 56, 62, 68, 75, 82 and 91).

xx¹ Available only in D, J, K, M tolerance

xx² Available only in J, K, M tolerance.

These products are protected under US Patents 7,172,985 & 7,670,981, other patents pending, and any foreign counterparts.

Table 2 – Chip Thickness/Packaging Quantities

Thickness Code	Case Size	Thickness ± Range (mm)	Paper Quantity		Plastic Quantity	
			7" Reel	13" Reel	7" Reel	13" Reel
AB	0201	0.30 ± 0.03	15,000	0	0	0
BB	0402	0.50 ± 0.05	10,000	50,000	0	0
BD	0402	0.55 ± 0.05	10,000	50,000	0	0
CB	0603	0.80 ± 0.07	4,000	10,000	0	0
CF	0603	0.80 ± 0.07	4,000	15,000	0	0
CH	0603	0.85 ± 0.07	4,000	10,000	0	0
DE	0805	0.70 ± 0.20	4,000	10,000	0	0
DC	0805	0.78 ± 0.10	4,000	10,000	0	0
DD	0805	0.90 ± 0.10	4,000	10,000	0	0
DF	0805	1.10 ± 0.10	0	0	2,500	10,000
DG	0805	1.25 ± 0.15	0	0	2,500	10,000
EB	1206	0.78 ± 0.10	4,000	10,000	4,000	10,000
EC	1206	0.90 ± 0.10	0	0	4,000	10,000
ED	1206	1.00 ± 0.10	0	0	2,500	10,000
EE	1206	1.10 ± 0.10	0	0	2,500	10,000
EF	1206	1.20 ± 0.15	0	0	2,500	10,000
EH	1206	1.60 ± 0.20	0	0	2,000	8,000
FB	1210	0.78 ± 0.10	0	0	4,000	10,000
FC	1210	0.90 ± 0.10	0	0	4,000	10,000
FE	1210	1.00 ± 0.10	0	0	2,500	10,000
FF	1210	1.10 ± 0.10	0	0	2,500	10,000
FG	1210	1.25 ± 0.15	0	0	2,500	10,000
FH	1210	1.55 ± 0.15	0	0	2,000	8,000
FM	1210	1.70 ± 0.20	0	0	2,000	8,000
FJ	1210	1.85 ± 0.20	0	0	2,000	8,000
FK	1210	2.10 ± 0.20	0	0	2,000	8,000
NC	1706	1.00 ± 0.15	0	0	4,000	10,000
LF	1808	1.00 ± 0.15	0	0	2,500	10,000
GB	1812	1.00 ± 0.10	0	0	1,000	4,000
GD	1812	1.25 ± 0.15	0	0	1,000	4,000
GH	1812	1.40 ± 0.15	0	0	1,000	4,000
GG	1812	1.55 ± 0.10	0	0	1,000	4,000
GK	1812	1.60 ± 0.20	0	0	1,000	4,000
GJ	1812	1.70 ± 0.15	0	0	1,000	4,000
GN	1812	1.70 ± 0.20	0	0	1,000	4,000
GM	1812	2.00 ± 0.20	0	0	500	2,000
HB	1825	1.10 ± 0.15	0	0	1,000	4,000
HE	1825	1.40 ± 0.15	0	0	1,000	4,000
HG	1825	1.60 ± 0.20	0	0	1,000	4,000
JB	2220	1.00 ± 0.15	0	0	1,000	4,000
JD	2220	1.30 ± 0.15	0	0	1,000	4,000
JE	2220	1.40 ± 0.15	0	0	1,000	4,000
JF	2220	1.50 ± 0.15	0	0	1,000	4,000
JG	2220	1.70 ± 0.15	0	0	1,000	4,000
JL	2220	2.00 ± 0.20	0	0	500	2,000
KE	2225	1.40 ± 0.15	0	0	1,000	4,000
Thickness Code	Case Size	Thickness ± Range (mm)	7" Reel	13" Reel	7" Reel	13" Reel
			Paper Quantity		Plastic Quantity	

Package quantity based on finished chip thickness specifications.

Table 3 – Chip Capacitor Land Pattern Design Recommendations per IPC–7351

EIA Size Code	Metric Size Code	Density Level A: Maximum (Most) Land Protrusion (mm)					Density Level B: Median (Nominal) Land Protrusion (mm)					Density Level C: Minimum (Least) Land Protrusion (mm)				
		C	Y	X	V1	V2	C	Y	X	V1	V2	C	Y	X	V1	V2
0201	0603	0.38	0.56	0.52	1.80	1.00	0.33	0.46	0.42	1.50	0.80	0.28	0.36	0.32	1.20	0.60
0402	1005	0.50	0.72	0.72	2.20	1.20	0.45	0.62	0.62	1.90	1.00	0.40	0.52	0.52	1.60	0.80
0603	1608	0.90	1.15	1.10	4.00	2.10	0.80	0.95	1.00	3.10	1.50	0.60	0.75	0.90	2.40	1.20
0805	2012	1.00	1.35	1.55	4.40	2.60	0.90	1.15	1.45	3.50	2.00	0.75	0.95	1.35	2.80	1.70
1206	3216	1.60	1.35	1.90	5.60	2.90	1.50	1.15	1.80	4.70	2.30	1.40	0.95	1.70	4.00	2.00
1210	3225	1.60	1.35	2.80	5.65	3.80	1.50	1.15	2.70	4.70	3.20	1.40	0.95	2.60	4.00	2.90
1210 ¹	3225	1.50	1.60	2.90	5.60	3.90	1.40	1.40	2.80	4.70	3.30	1.30	1.20	2.70	4.00	3.00
1808	4520	2.30	1.75	2.30	7.40	3.30	2.20	1.55	2.20	6.50	2.70	2.10	1.35	2.10	5.80	2.40
1812	4532	2.15	1.60	3.60	6.90	4.60	2.05	1.40	3.50	6.00	4.00	1.95	1.20	3.40	5.30	3.70
1825	4564	2.15	1.60	6.90	6.90	7.90	2.05	1.40	6.80	6.00	7.30	1.95	1.20	6.70	5.30	7.00
2220	5650	2.75	1.70	5.50	8.20	6.50	2.65	1.50	5.40	7.30	5.90	2.55	1.30	5.30	6.60	5.60
2225	5664	2.70	1.70	6.90	8.10	7.90	2.60	1.50	6.80	7.20	7.30	2.50	1.30	6.70	6.50	7.00

¹ Only for capacitance values $\geq 22 \mu\text{F}$

Density Level A: For low-density product applications. Recommended for wave solder applications and provides a wider process window for reflow solder processes. KEMET only recommends wave soldering of EIA 0603, 0805 and 1206 case sizes.

Density Level B: For products with a moderate level of component density. Provides a robust solder attachment condition for reflow solder processes.

Density Level C: For high component density product applications. Before adapting the minimum land pattern variations the user should perform qualification testing based on the conditions outlined in IPC Standard 7351 (IPC–7351).

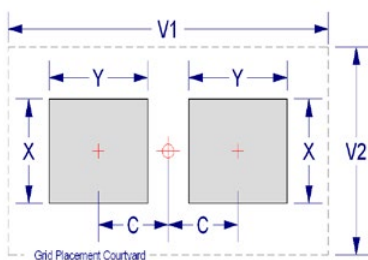

Soldering Process

Recommended Soldering Technique:

- Solder wave or solder reflow for EIA case sizes 0603, 0805 and 1206
- All other EIA case sizes are limited to solder reflow only

Recommended Soldering Profile:

- KEMET recommends following the guidelines outlined in IPC/JEDEC J–STD–020

Table 4 – Performance & Reliability: Test Methods and Conditions

Stress	Reference	Test or Inspection Method
Terminal Strength	JIS-C-6429	Appendix 1, Note: Force of 1.8 kg for 60 seconds.
Board Flex	JIS-C-6429	Appendix 2, Note: Standard termination system – 2.0 mm (minimum) for all except 3 mm for COG. Flexible termination system – 3.0 mm (minimum).
Solderability	J-STD-002	Magnification 50 X. Conditions:
		a) Method B, 4 hours @ 155°C, dry heat @ 235°C
		b) Method B @ 215°C category 3
		c) Method D, category 3 @ 260°C
Temperature Cycling	JESD22 Method JA-104	1,000 Cycles (-55°C to +125°C). Measurement at 24 hours +/- 2 hours after test conclusion.
Biased Humidity	MIL-STD-202 Method 103	Load Humidity: 1,000 hours 85°C/85% RH and rated voltage. Add 100 K ohm resistor. Measurement at 24 hours +/- 2 hours after test conclusion.
		Low Volt Humidity: 1,000 hours 85°C/85% RH and 1.5 V. Add 100 K ohm resistor. Measurement at 24 hours +/- 2 hours after test conclusion.
Moisture Resistance	MIL-STD-202 Method 106	t = 24 hours/cycle. Steps 7a and 7b not required. Unpowered. Measurement at 24 hours +/- 2 hours after test conclusion.
Thermal Shock	MIL-STD-202 Method 107	-55°C/+125°C. Note: Number of cycles required – 300, maximum transfer time – 20 seconds, dwell time – 15 minutes. Air – Air.
High Temperature Life	MIL-STD-202 Method 108 /EIA-198	1,000 hours at 125°C (85°C for X5R, Z5U and Y5V) with 2 X rated voltage applied.
Storage Life	MIL-STD-202 Method 108	150°C, 0 VDC for 1,000 hours.
Vibration	MIL-STD-202 Method 204	5 g's for 20 min., 12 cycles each of 3 orientations. Note: Use 8" X 5" PCB 0.031" thick 7 secure points on one long side and 2 secure points at corners of opposite sides. Parts mounted within 2" from any secure point. Test from 10 – 2,000 Hz
Mechanical Shock	MIL-STD-202 Method 213	Figure 1 of Method 213, Condition F.
Resistance to Solvents	MIL-STD-202 Method 215	Add aqueous wash chemical, OKEM Clean or equivalent.

Storage and Handling

Ceramic chip capacitors should be stored in normal working environments. While the chips themselves are quite robust in other environments, solderability will be degraded by exposure to high temperatures, high humidity, corrosive atmospheres, and long term storage. In addition, packaging materials will be degraded by high temperature– reels may soften or warp and tape peel force may increase. KEMET recommends that maximum storage temperature not exceed 40°C and maximum storage humidity not exceed 70% relative humidity. Temperature fluctuations should be minimized to avoid condensation on the parts and atmospheres should be free of chlorine and sulfur bearing compounds. For optimized solderability chip stock should be used promptly, preferably within 1.5 years of receipt.

Construction

Reference	Item		Material
A	Termination System	Finish	100% Matte Sn
B		Barrier Layer	Ni
C		Base Metal	Cu
D	Inner Electrode		Ni
E	Dielectric Material		CaZrO ₃

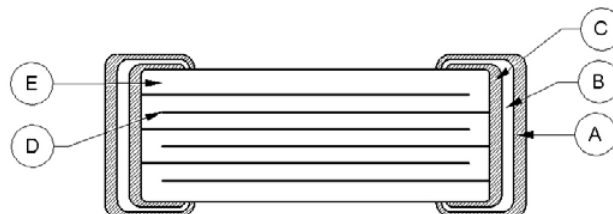

Note: Image is exaggerated in order to clearly identify all components of construction.

Capacitor Marking (Optional):

Laser marking option is not available on:

- COG, Ultra Stable X8R and Y5V dielectric devices
- EIA 0402 case size devices
- EIA 0603 case size devices with Flexible Termination option.
- KPS Commercial and Automotive grade stacked devices.

These capacitors are supplied unmarked only.

Overview

KEMET's X7R dielectric features a 125°C maximum operating temperature and is considered "temperature stable." The Electronics Components, Assemblies & Materials Association (EIA) characterizes X7R dielectric as a Class II material. Components of this classification are fixed, ceramic dielectric capacitors suited for bypass and decoupling applications

or for frequency discriminating circuits where Q and stability of capacitance characteristics are not critical. X7R exhibits a predictable change in capacitance with respect to time and voltage and boasts a minimal change in capacitance with reference to ambient temperature. Capacitance change is limited to $\pm 15\%$ from -55°C to +125°C.

Benefits

- -55°C to +125°C operating temperature range
- Pb-Free and RoHS Compliant
- Temperature stable dielectric
- EIA 0402, 0603, 0805, 1206, 1210, 1808, 1812, 1825, 2220, and 2225 case sizes
- DC voltage ratings of 6.3 V, 10 V, 16 V, 25 V, 50 V, 100 V, 200 V, and 250 V
- Capacitance offerings ranging from 10 pF to 47 μ F
- Available capacitance tolerances of $\pm 5\%$, $\pm 10\%$, and $\pm 20\%$
- Non-polar device, minimizing installation concerns
- 100% pure matte tin-plated termination finish allowing for excellent solderability
- SnPb termination finish option available upon request (5% minimum)

Applications

Typical applications include decoupling, bypass, filtering and transient voltage suppression.

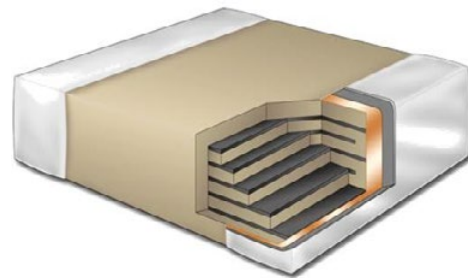

Ordering Information

C	1206	C	106	M	4	R	A	C	TU
Ceramic	Case Size (L" x W")	Specification/ Series ¹	Capacitance Code (pF)	Capacitance Tolerance	Voltage	Dielectric	Failure Rate/ Design	Termination Finish ²	Packaging/Grade (C-Spec) ³
	0402 0603 0805 1206 1210 1808 1812 1825 2220 2225	C = Standard	2 Significant Digits + Number of Zeros	J = $\pm 5\%$ K = $\pm 10\%$ M = $\pm 20\%$	9 = 6.3 V 8 = 10 V 4 = 16 V 3 = 25 V 6 = 35 V 5 = 50 V 1 = 100 V 2 = 200 V A = 250 V	R = X7R	A = N/A	C = 100% Matte Sn	Blank = Bulk TU = 7" Reel Unmarked TM = 7" Reel Marked

¹ Flexible termination option is available. Please see FT-CAP product bulletin C1013_X7R_FT-CAP_SMD.

² Additional termination finish options may be available. Contact KEMET for details.

³ Additional reeling or packaging options may be available. Contact KEMET for details.

Dimensions – Millimeters (Inches)

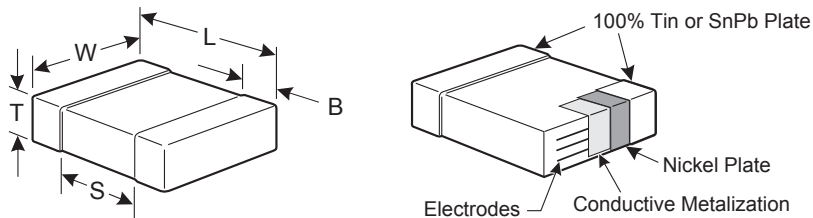

EIA Size Code	Metric Size Code	L Length	W Width	T Thickness	B Bandwidth	S Separation Minimum	Mounting Technique
0402	1005	1.00 (.040) ±0.05 (.002)	0.50 (.020) ±0.05 (.002)	See Table 2 for Thickness	0.30 (.012) ±0.10 (.004)	0.30 (.012)	Solder Reflow Only
0603	1608	1.60 (.063) ±0.15 (.006)	0.80 (.032) ±0.15 (.006)		0.35 (.014) ±0.15 (.006)	0.70 (.028)	Solder Wave or Solder Reflow
0805	2012	2.00 (.079) ±0.20 (.008)	1.25 (.049) ±0.20 (.008)		0.50 (0.02) ±0.25 (.010)	0.75 (.030)	
1206	3216	3.20 (.126) ±0.20 (.008)	1.60 (.063) ±0.20 (.008)		0.50 (0.02) ±0.25 (.010)	N/A	Solder Reflow Only
1210 ¹	3225	3.20 (.126) ±0.20 (.008)	2.50 (.098) ±0.20 (.008)		0.50 (0.02) ±0.25 (.010)		
1808	4520	4.70 (.185) ±0.50 (.020)	2.00 (.079) ±0.20 (.008)		0.60 (.024) ±0.35 (.014)		
1812	4532	4.50 (.177) ±0.30 (.012)	3.20 (.126) ±0.30 (.012)		0.60 (.024) ±0.35 (.014)		
1825	4564	4.50 (.177) ±0.30 (.012)	6.40 (.252) ±0.40 (.016)		0.60 (.024) ±0.35 (.014)		
2220	5650	5.70 (.224) ±0.40 (.016)	5.00 (.197) ±0.40 (.016)		0.60 (.024) ±0.35 (.014)		
2225	5664	5.60 (.220) ±0.40 (.016)	6.40 (.248) ±0.40 (.016)		0.60 (.024) ±0.35 (.014)		

¹ For capacitance values ≥ 12 μF add 0.02 (0.001) to the width tolerance dimension.

Qualification/Certification

Commercial Grade products are subject to internal qualification. Details regarding test methods and conditions are referenced in Table 4, Performance & Reliability.

Environmental Compliance

Pb-Free and RoHS Compliant.



RoHS Compliant

Electrical Parameters/Characteristics

Item	Parameters/Characteristics
Operating Temperature Range	-55°C to +125°C
Capacitance Change with Reference to +25°C and 0 VDC Applied (TCC)	±15%
Aging Rate (Maximum % Capacitance Loss/Decade Hour)	3.0%
Dielectric Withstanding Voltage (DWV)	250% of rated voltage (5 ±1 second and charge/discharge not exceeding 50 mA)
Dissipation Factor (DF) Maximum Limit @ 25°C	See Dissipation Factor (DF) Limits Table
Insulation Resistance (IR) Limit @ 25°C	See Insulation Resistance Limit Table (Rated voltage applied for 120 ±5 seconds @ 25°C)

Regarding aging rate: Capacitance measurements (including tolerance) are indexed to a referee time of 48 or 1,000 hours. Please refer to a part number specific datasheet for referee time details.

To obtain IR limit, divide $M\Omega\text{-}\mu\text{F}$ value by the capacitance and compare to $G\Omega$ limit. Select the lower of the two limits.

Capacitance and dissipation factor (DF) measured under the following conditions:

1 kHz ±50 Hz and 1.0 ±0.2 Vrms if capacitance ≤ 10 μF

120 Hz ±10 Hz and 0.5 ±0.1 Vrms if capacitance > 10 μF

Note: When measuring capacitance it is important to ensure the set voltage level is held constant. The HP4284 and Agilent E4980 have a feature known as Automatic Level Control (ALC). The ALC feature should be switched to "ON."

Insulation Resistance Limit Table (X7R Dielectric)

EIA Case Size	1,000 Megohm Microfarads or 100 GΩ	500 Megohm Microfarads or 10 GΩ
0201	N/A	ALL
0402	< 0.012 μF	≥ 0.012 μF
0603	< 0.047 μF	≥ 0.047 μF
0805	< 0.047 μF	≥ 0.047 μF
1206	< 0.22 μF	≥ 0.22 μF
1210	< 0.39 μF	≥ 0.39 μF
1808	ALL	N/A
1812	< 2.2 μF	≥ 2.2 μF
1825	ALL	N/A
2220	< 10 μF	≥ 10 μF
2225	ALL	N/A

Dissipation Factor (DF) Limits Table

EIA Case Size	Rated DC Voltage	Capacitance	Dissipation Factor
0402	< 16	All	5.0%
	16/25		3.5%
	> 25		2.5%
0603	< 16	< 1.0 μ F	5.0%
	16/25		3.5%
	> 25		2.5%
	< 16	\geq 1.0 μ F	10.0%
	16/25		
0805	< 16	\leq 2.2 μ F	5.0%
	16/25		3.5%
	> 25	< 1.0 μ F	2.5%
	< 16	> 2.2 μ F	10.0%
	16/25		
	> 25		
1206	< 16	< 10 μ F	5.0%
	16/25		3.5%
	> 25		2.5%
	< 16	\geq 10 μ F	10.0%
	16/25		
1210	< 16	< 22 μ F	5.0%
	16/25		3.5%
	> 25		2.5%
	< 16	\geq 22 μ F	10.0%
	16/25		
1812 – 2225	< 16	All	5.0%
	16/25		3.5%
	> 25		2.5%

Post Environmental Limits

High Temperature Life, Biased Humidity, Moisture Resistance						
Dielectric	Case Size	Rated DC Voltage	Capacitance Value	Dissipation Factor (Maximum %)	Capacitance Shift	Insulation Resistance
X7R	0402	< 16	All	7.5	±20%	10% of Initial Limit
		16/25		5.0		
		> 25		3.0		
	0603	< 16	< 1.0 μ F	7.5		
		16/25		5.0		
		> 25		3.0		
		< 16	\geq 1.0 μ F	20.0		
		16/25				
		> 25				
	0805	< 16	\leq 2.2 μ F	7.5		
		16/25		5.0		
		> 25		3.0		
		< 16	> 2.2 μ F	20.0		
		16/25				
		> 25				
	1206	< 16	< 10 μ F	7.5		
		16/25		5.0		
		> 25		3.0		
		< 16	\geq 10 μ F	20.0		
		16/25				
		> 25				
	1210	< 16	< 22 μ F	7.5		
		16/25		5.0		
		> 25		3.0		
< 16		\geq 22 μ F	20.0			
16/25						
> 25						
1808 – 2225	< 16	All	7.5			
	16/25		5.0			
	> 25		3.0			

Table 1B – Capacitance Range/Selection Waterfall (1210 – 2225 Case Sizes)

Cap	Cap Code	Case Size / Series			C1210C								C1808C			C1812C					C1825C				C2220C					C2225C						
		Voltage Code			9	8	4	3	5	1	2	A	5	1	2	3	5	1	2	A	5	1	2	A	3	5	1	2	A	5	1	2	A			
		Rated Voltage (VDC)			6.3	10	16	25	50	100	200	250	50	100	200	25	50	100	200	250	50	100	200	250	25	50	100	200	250	50	100	200	250			
		Cap Tolerance			Product Availability and Chip Thickness Codes – See Table 2 for Chip Thickness Dimensions																															
10 - 91 pF*	100 - 910*	J	K	M	FB	FB	FB	FB	FB	FB	FB																									
100 - 270 pF**	101 - 271**	J	K	M	FB	FB	FB	FB	FB	FB	FB																									
330 pF	331	J	K	M	FB	FB	FB	FB	FB	FB	FB				LF	LF	LF																			
390 pF	391	J	K	M	FB	FB	FB	FB	FB	FB	FB				LF	LF	LF																			
470 - 1,200 pF**	471 - 122**	J	K	M	FB	FB	FB	FB	FB	FB	FB				LF	LF	LF	GB	GB	GB	GB															
1,500 pF	152	J	K	M	FB	FB	FB	FB	FB	FB	FE				LF	LF	LF	GB	GB	GB	GB															
1,800 pF	182	J	K	M	FB	FB	FB	FB	FB	FB	FE				LF	LF	LF	GB	GB	GB	GB															
2,200 pF	222	J	K	M	FB	FB	FB	FB	FB	FB	FB				LF	LF	LF	GB	GB	GB	GB															
2,700 pF	272	J	K	M	FB	FB	FB	FB	FB	FB	FB				LF	LF	LF	GB	GB	GB	GB															
3,300 pF	332	J	K	M	FB	FB	FB	FB	FB	FB	FB				LF	LF	LF	GB	GB	GB	GB															
3,900 pF	392	J	K	M	FB	FB	FB	FB	FB	FB	FB				LF	LF		GB	GB	GB	GB		HB	HB	HB											
4,700 pF	472	J	K	M	FB	FB	FB	FB	FB	FB	FB				LD	LD	LD	GB	GB	GB	GD		HB	HB	HB									KE	KE	KE
5,600 pF	562	J	K	M	FB	FB	FB	FB	FB	FB	FB				LD	LD	LD	GB	GB	GB	GH		HB	HB	HB									KE	KE	KE
6,800 pF	682	J	K	M	FB	FB	FB	FB	FB	FB	FB				LD	LD	LD	GB	GB	GB	GB		HB	HB	HB	JE	JE	JE						KE	KE	KE
8,200 pF	822	J	K	M	FB	FB	FB	FB	FB	FB	FB				LD	LD	LD	GB	GB	GB	GB		HB	HB	HB	JE	JE	JE						KE	KE	KE
10,000 pF	103	J	K	M	FB	FB	FB	FB	FB	FB	FB				LD	LD	LD	GB	GB	GB	GB		HB	HB	HE	JE	JE	JE						KE	KE	KE
12,000 pF	123	J	K	M	FB	FB	FB	FB	FB	FB	FB				LD	LD	LD	GB	GB	GB	GB		HB	HB	HE	JE	JE	JE						KE	KE	KE
15,000 pF	153	J	K	M	FB	FB	FB	FB	FB	FB	FB				LD	LD	LD	GB	GB	GB	GB		HB	HB		JE	JE	JE						KE	KE	KE
18,000 pF	183	J	K	M	FB	FB	FB	FB	FB	FB	FB				LD	LD	LD	GB	GB	GB	GB		HB	HE		JE	JE	JE						KE	KE	
22,000 pF	223	J	K	M	FB	FB	FB	FB	FB	FB	FB				LD	LD	LD	GB	GB	GB	GB		HB	HB	HB	JE	JE	JE						KE	KE	
27,000 pF	273	J	K	M	FB	FB	FB	FB	FB	FB	FB				LD	LD		GB	GB	GB	GB		HB	HB	HB	JE	JE	JE						KE	KE	
33,000 pF	333	J	K	M	FB	FB	FB	FB	FB	FB	FB				LD	LD		GB	GB	GB	GB		HB	HB	HB	JB	JB	JB						KE		
39,000 pF	393	J	K	M	FB	FB	FB	FB	FB	FB	FB				LD	LD		GB	GB	GB	GB		HB	HB	HB	JB	JB	JB								
47,000 pF	473	J	K	M	FB	FB	FB	FB	FB	FB	FC				LD	LD	LD	GB	GB	GB	GB		HB	HB	HB	JB	JB	JB								
56,000 pF	563	J	K	M	FB	FB	FB	FB	FB	FB	FC				LD	LD	LD	GB	GB	GB	GB		HB	HB	HB	JB	JB	JB								
68,000 pF	683	J	K	M	FB	FB	FB	FB	FB	FB	FC				LD	LD		GB	GB	GB	GB		HB	HB	HB	JB	JB	JB								
82,000 pF	823	J	K	M	FB	FB	FB	FB	FB	FC	FF				LD			GB	GB	GB	GB		HB	HB	HB	JC	JC	JC	JC	JC						
0.10 µF	104	J	K	M	FB	FB	FB	FB	FD	FG	FG				LD			GB	GB	GB	GB		HB	HB	HB	JC	JC	JC	JC	JC	KC	KC	KC	KC		
0.12 µF	124	J	K	M	FB	FB	FB	FB	FD						LD			GB	GB	GB	GB		HB	HB	HB	JC	JC	JC	JC	JC	KC	KC	KC	KC		
0.15 µF	154	J	K	M	FC	FC	FC	FC	FD						LD			GB	GB	GB	GE		HB	HB	HB	JC	JC	JC	JC	JC	KC	KC	KC	KC		
0.18 µF	184	J	K	M	FC	FC	FC	FC	FD						LD			GB	GB	GB	GG		HB	HB	HB	JC	JC	JC	JC	JC	KC	KC	KC	KC		
0.22 µF	224	J	K	M	FC	FC	FC	FC	FD									GB	GB	GB	GG		HB	HB	HB	JC	JC	JC	JC	JC	KC	KC	KC	KC		
0.27 µF	274	J	K	M	FC	FC	FC	FC	FD									GB	GB	GG	GG		HB	HB	HB	JC	JC	JC	JC	JC	KC	KC	KC	KC		
0.33 µF	334	J	K	M	FD	FD	FD	FD	FD									GB	GB	GG	GG		HB	HB	HB	JC	JC	JC	JC	JC	KB	KC	KC	KC		
0.39 µF	394	J	K	M	FD	FD	FD	FD	FD									GB	GB	GG	GG		HB	HB	HD	JC	JC	JC	JC	JC	KB	KC	KC	KC		
0.47 µF	474	J	K	M	FD	FD	FD	FD	FD									GB	GB	GG	GJ		HB	HB	HD	JC	JC	JC	JC	JC	KB	KC	KD	KD		
0.56 µF	564	J	K	M	FD	FD	FD	FD	FD									GC	GC	GG			HB	HD	HD	JC	JC	JC	JD	JD	KB	KC	KD	KD		
0.68 µF	684	J	K	M	FD	FD	FD	FD	FD									GC	GC	GG			HB	HD	HD	JC	JC	JD	JD	JD	KB	KC	KD	KD		
0.82 µF	824	J	K	M	FF	FF	FF	FF	FL									GE	GE	GG			HB	HF	HF	JC	JC	JF	JF	JF	KB	KC	KE	KE		
1.0 µF	105	J	K	M	FH	FH	FH	FH	FM									GE	GE	GG			HB	HF	HF	JC	JC	JF	JF	JF	KB	KD	KE	KE		
1.2 µF	125	J	K	M	FH	FH	FH	FH	FG														HB			JC	JC				KB	KE	KE	KE		
1.5 µF	155	J	K	M	FH	FH	FH	FH	FG														HC			JC	JC				KC					
1.8 µF	185	J	K	M	FH	FH	FH	FH	FG														HD			JD	JD				KD					

*Capacitance range Includes E24 decade values only. (i.e., 10, 11, 12, 13, 15, 16, 18, 20, 22, 24, 27, 30, 33, 36, 39, 43, 47, 51, 56, 62, 68, 75, 82 and 91)

**Capacitance range Includes E12 decade values only. (i.e., 10, 12, 15, 18, 22, 27, 33, 39, 47, 56, 68 and 82)

xx¹ Available only in K, M tolerance.

xx² Available only in M tolerance.

Table 2 – Chip Thickness/Packaging Quantities cont'd

Thickness Code	Case Size	Thickness ± Range (mm)	Paper Quantity		Plastic Quantity	
			7" Reel	13" Reel	7" Reel	13" Reel
EM	1206	1.25 ± 0.15	0	0	2,500	10,000
EG	1206	1.60 ± 0.15	0	0	2,000	8,000
EH	1206	1.60 ± 0.20	0	0	2,000	8,000
FB	1210	0.78 ± 0.10	0	0	4,000	10,000
FC	1210	0.90 ± 0.10	0	0	4,000	10,000
FD	1210	0.95 ± 0.10	0	0	4,000	10,000
FE	1210	1.00 ± 0.10	0	0	2,500	10,000
FF	1210	1.10 ± 0.10	0	0	2,500	10,000
FG	1210	1.25 ± 0.15	0	0	2,500	10,000
FL	1210	1.40 ± 0.15	0	0	2,000	8,000
FH	1210	1.55 ± 0.15	0	0	2,000	8,000
FM	1210	1.70 ± 0.20	0	0	2,000	8,000
FJ	1210	1.85 ± 0.20	0	0	2,000	8,000
FT	1210	1.90 ± 0.20	0	0	1,500	4,000
FK	1210	2.10 ± 0.20	0	0	2,000	8,000
FS	1210	2.50 ± 0.30	0	0	1,000	4,000
NA	1706	0.90 ± 0.10	0	0	4,000	10,000
NC	1706	1.00 ± 0.15	0	0	4,000	10,000
LD	1808	0.90 ± 0.10	0	0	2,500	10,000
LF	1808	1.00 ± 0.15	0	0	2,500	10,000
GB	1812	1.00 ± 0.10	0	0	1,000	4,000
GC	1812	1.10 ± 0.10	0	0	1,000	4,000
GD	1812	1.25 ± 0.15	0	0	1,000	4,000
GE	1812	1.30 ± 0.10	0	0	1,000	4,000
GH	1812	1.40 ± 0.15	0	0	1,000	4,000
GG	1812	1.55 ± 0.10	0	0	1,000	4,000
GK	1812	1.60 ± 0.20	0	0	1,000	4,000
GJ	1812	1.70 ± 0.15	0	0	1,000	4,000
GO	1812	2.50 ± 0.20	0	0	500	2,000
HB	1825	1.10 ± 0.15	0	0	1,000	4,000
HC	1825	1.15 ± 0.15	0	0	1,000	4,000
HD	1825	1.30 ± 0.15	0	0	1,000	4,000
HE	1825	1.40 ± 0.15	0	0	1,000	4,000
HF	1825	1.50 ± 0.15	0	0	1,000	4,000
JB	2220	1.00 ± 0.15	0	0	1,000	4,000
JC	2220	1.10 ± 0.15	0	0	1,000	4,000
JD	2220	1.30 ± 0.15	0	0	1,000	4,000
JE	2220	1.40 ± 0.15	0	0	1,000	4,000
JF	2220	1.50 ± 0.15	0	0	1,000	4,000
JO	2220	2.40 ± 0.15	0	0	500	2,000
KB	2225	1.00 ± 0.15	0	0	1,000	4,000
KC	2225	1.10 ± 0.15	0	0	1,000	4,000
KD	2225	1.30 ± 0.15	0	0	1,000	4,000
KE	2225	1.40 ± 0.15	0	0	1,000	4,000
Thickness Code	Case Size	Thickness ± Range (mm)	7" Reel	13" Reel	7" Reel	13" Reel
			Paper Quantity		Plastic Quantity	

Package quantity based on finished chip thickness specifications.

Table 3 – Chip Capacitor Land Pattern Design Recommendations per IPC–7351

EIA Size Code	Metric Size Code	Density Level A: Maximum (Most) Land Protrusion (mm)					Density Level B: Median (Nominal) Land Protrusion (mm)					Density Level C: Minimum (Least) Land Protrusion (mm)				
		C	Y	X	V1	V2	C	Y	X	V1	V2	C	Y	X	V1	V2
0402	1005	0.50	0.72	0.72	2.20	1.20	0.45	0.62	0.62	1.90	1.00	0.40	0.52	0.52	1.60	0.80
0603	1608	0.90	1.15	1.10	4.00	2.10	0.80	0.95	1.00	3.10	1.50	0.60	0.75	0.90	2.40	1.20
0805	2012	1.00	1.35	1.55	4.40	2.60	0.90	1.15	1.45	3.50	2.00	0.75	0.95	1.35	2.80	1.70
1206	3216	1.60	1.35	1.90	5.60	2.90	1.50	1.15	1.80	4.70	2.30	1.40	0.95	1.70	4.00	2.00
1210	3225	1.60	1.35	2.80	5.65	3.80	1.50	1.15	2.70	4.70	3.20	1.40	0.95	2.60	4.00	2.90
1210 ¹	3225	1.50	1.60	2.90	5.60	3.90	1.40	1.40	2.80	4.70	3.30	1.30	1.20	2.70	4.00	3.00
1808	4520	2.30	1.75	2.30	7.40	3.30	2.20	1.55	2.20	6.50	2.70	2.10	1.35	2.10	5.80	2.40
1812	4532	2.15	1.60	3.60	6.90	4.60	2.05	1.40	3.50	6.00	4.00	1.95	1.20	3.40	5.30	3.70
1825	4564	2.15	1.60	6.90	6.90	7.90	2.05	1.40	6.80	6.00	7.30	1.95	1.20	6.70	5.30	7.00
2220	5650	2.75	1.70	5.50	8.20	6.50	2.65	1.50	5.40	7.30	5.90	2.55	1.30	5.30	6.60	5.60
2225	5664	2.70	1.70	6.90	8.10	7.90	2.60	1.50	6.80	7.20	7.30	2.50	1.30	6.70	6.50	7.00

¹ Only for capacitance values $\geq 22 \mu\text{F}$

Density Level A: For low-density product applications. Recommended for wave solder applications and provides a wider process window for reflow solder processes. KEMET only recommends wave soldering of EIA 0603, 0805, and 1206 case sizes.

Density Level B: For products with a moderate level of component density. Provides a robust solder attachment condition for reflow solder processes.

Density Level C: For high component density product applications. Before adapting the minimum land pattern variations the user should perform qualification testing based on the conditions outlined in IPC Standard 7351 (IPC–7351).

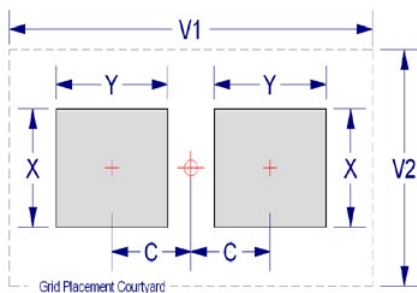

Soldering Process

Recommended Soldering Technique:

- Solder wave or solder reflow for EIA case sizes 0603, 0805, and 1206
- All other EIA case sizes are limited to solder reflow only

Recommended Soldering Profile:

- KEMET recommends following the guidelines outlined in IPC/JEDEC J–STD–020

Table 4 – Performance & Reliability: Test Methods and Conditions

Stress	Reference	Test or Inspection Method
Terminal Strength	JIS-C-6429	Appendix 1, Note: Force of 1.8 kg for 60 seconds.
Board Flex	JIS-C-6429	Appendix 2, Note: Standard termination system – 2.0 mm (minimum) for all except 3 mm for COG. Flexible termination system – 3.0 mm (minimum).
Solderability	J-STD-002	Magnification 50 X. Conditions:
		a) Method B, 4 hours @ 155°C, dry heat @ 235°C
		b) Method B @ 215°C category 3
		c) Method D, category 3 @ 260°C
Temperature Cycling	JESD22 Method JA-104	1,000 Cycles (-55°C to +125°C). Measurement at 24 hours +/- 2 hours after test conclusion.
Biased Humidity	MIL-STD-202 Method 103	Load Humidity: 1,000 hours 85°C/85% RH and rated voltage. Add 100 K ohm resistor. Measurement at 24 hours +/- 2 hours after test conclusion.
		Low Volt Humidity: 1,000 hours 85°C/85% RH and 1.5 V. Add 100 K ohm resistor. Measurement at 24 hours +/- 2 hours after test conclusion.
Moisture Resistance	MIL-STD-202 Method 106	t = 24 hours/cycle. Steps 7a and 7b not required. Unpowered. Measurement at 24 hours +/- 2 hours after test conclusion.
Thermal Shock	MIL-STD-202 Method 107	-55°C/+125°C. Note: Number of cycles required – 300, maximum transfer time – 20 seconds, dwell time – 15 minutes. Air – Air.
High Temperature Life	MIL-STD-202 Method 108 /EIA-198	1,000 hours at 125°C (85°C for X5R, Z5U and Y5V) with 2 X rated voltage applied.
Storage Life	MIL-STD-202 Method 108	150°C, 0 VDC for 1,000 hours.
Vibration	MIL-STD-202 Method 204	5 g's for 20 min., 12 cycles each of 3 orientations. Note: Use 8" X 5" PCB 0.031" thick 7 secure points on one long side and 2 secure points at corners of opposite sides. Parts mounted within 2" from any secure point. Test from 10 – 2,000 Hz
Mechanical Shock	MIL-STD-202 Method 213	Figure 1 of Method 213, Condition F.
Resistance to Solvents	MIL-STD-202 Method 215	Add aqueous wash chemical, OKEM Clean or equivalent.

Storage & Handling

Ceramic chip capacitors should be stored in normal working environments. While the chips themselves are quite robust in other environments, solderability will be degraded by exposure to high temperatures, high humidity, corrosive atmospheres, and long term storage. In addition, packaging materials will be degraded by high temperature—reels may soften or warp and tape peel force may increase. KEMET recommends that maximum storage temperature not exceed 40°C and maximum storage humidity not exceed 70% relative humidity. Temperature fluctuations should be minimized to avoid condensation on the parts and atmospheres should be free of chlorine and sulfur bearing compounds. For optimized solderability chip stock should be used promptly, preferably within 1.5 years of receipt.

Construction

Reference	Item	Material
A	Termination System	Finish
B		Barrier Layer
C		Base Metal
D	Inner Electrode	Ni
E	Dielectric Material	BaTiO ₃

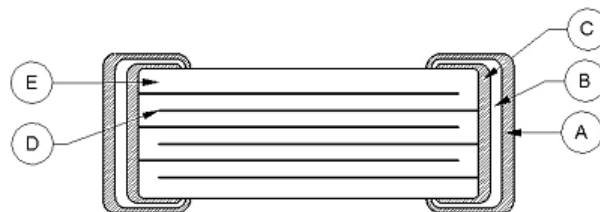

Note: Image is exaggerated in order to clearly identify all components of construction.

Surface Mount Multilayer Ceramic Chip Capacitors (SMD MLCCs)
X5R Dielectric, 4 – 50 VDC (Commercial Grade)

Overview

KEMET’s X5R dielectric features an 85°C maximum operating temperature and is considered “semi-stable.” The Electronics Components, Assemblies & Materials Association (EIA) characterizes X5R dielectric as a Class II material. Components of this classification are fixed, ceramic dielectric capacitors suited for bypass and decoupling applications or for frequency

discriminating circuits where Q and stability of capacitance characteristics are not critical. X5R exhibits a predictable change in capacitance with respect to time and voltage and boasts a minimal change in capacitance with reference to ambient temperature. Capacitance change is limited to ±15% from -55°C to +85°C.

Benefits

- -55°C to +85°C operating temperature range
- Pb-Free and RoHS Compliant
- Temperature stable dielectric
- EIA 0201, 0402, 0603, 0805, 1206, and 1210 case sizes
- DC voltage ratings of 4 V, 6.3 V, 10 V, 16 V, 25 V, 35 V, and 50 V
- Capacitance offerings ranging from 0.01 µF to 100 µF
- Available capacitance tolerances of ±10% and ±20%
- Non-polar device, minimizing installation concerns
- 100% pure matte tin-plated termination finish allowing for excellent solderability

Applications

Typical applications include decoupling, bypass, and filtering.

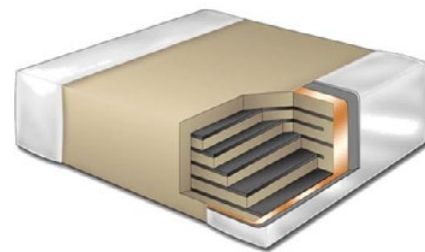

Ordering Information

C	1206	C	107	M	9	P	A	C	TU
Ceramic	Case Size (L" x W")	Specification/ Series	Capacitance Code (pF)	Capacitance Tolerance	Voltage	Dielectric	Failure Rate/ Design	Termination Finish ¹	Packaging/Grade (C-Spec) ²
	0201 0402 0603 0805 1206 1210	C = Standard	2 Significant Digits + Number of Zeros	K = ±10% M = ±20%	7 = 4 V 9 = 6.3 V 8 = 10 V 4 = 16 V 3 = 25 V 6 = 35 V 5 = 50 V	P = X5R	A = N/A	C = 100% Matte Sn	Blank = Bulk TU = 7" Reel Unmarked TM = 7" Reel Marked

¹ Additional termination finish options may be available. Contact KEMET for details.

² Additional reeling or packaging options may be available. Contact KEMET for details.

Dimensions – Millimeters (Inches)

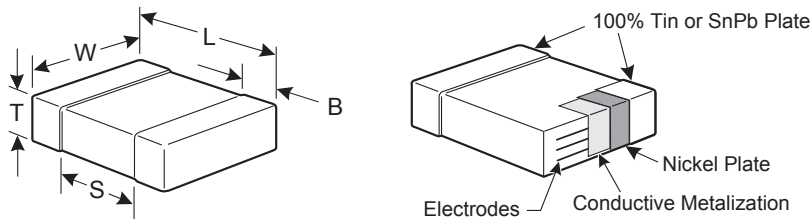

EIA Size Code	Metric Size Code	L Length	W Width	T Thickness	B Bandwidth	S Separation Minimum	Mounting Technique
0201	0603	0.60 (.024) ± 0.03 (.001)	0.30 (.012) ± 0.03 (.001)	See Table 2 for Thickness	0.15 (.006) ± 0.05 (.002)	N/A	Solder Reflow Only
0402	1005	1.00 (.040) ± 0.05 (.002)	0.50 (.020) ± 0.05 (.002)		0.30 (.012) ± 0.10 (.004)	0.30 (.012)	
0603	1608	1.60 (.063) ± 0.15 (.006)	0.80 (.032) ± 0.15 (.006)		0.35 (.014) ± 0.15 (.006)	0.70 (.028)	Solder Wave or Solder Reflow
0805	2012	2.00 (.079) ± 0.20 (.008)	1.25 (.049) ± 0.20 (.008)		0.50 (0.02) ± 0.25 (.010)	0.75 (.030)	
1206	3216	3.20 (.126) ± 0.20 (.008)	1.60 (.063) ± 0.20 (.008)		0.50 (0.02) ± 0.25 (.010)	N/A	Solder Reflow Only
1210 ¹	3225	3.20 (.126) ± 0.20 (.008)	2.50 (.098) ± 0.20 (.008)		0.50 (0.02) ± 0.25 (.010)		

¹ For capacitance values ≥ 22 μF add 0.10 (0.004) to the length and width tolerance dimension and add 0.15 (0.006) to the positive bandwidth tolerance dimension.

Qualification/Certification

Commercial Grade products are subject to internal qualification. Details regarding test methods and conditions are referenced in Table 4, Performance & Reliability.

Environmental Compliance

Pb-Free and RoHS Compliant.



RoHS Compliant

Electrical Parameters/Characteristics

Item	Parameters/Characteristics
Operating Temperature Range	-55°C to +85°C
Capacitance Change with Reference to +25°C and 0 VDC Applied (TCC)	±15%
Aging Rate (Maximum % Capacitance Loss/Decade Hour)	4.0%
Dielectric Withstanding Voltage (DWV)	250% of rated voltage (5 ±1 seconds and charge/discharge not exceeding 50 mA)
Dissipation Factor (DF) Maximum Limit @ 25°C	See Dissipation Factor Limit Table
Insulation Resistance (IR) Limit @ 25°C	See Insulation Resistance Limit Table (Rated voltage applied for 120 ±5 seconds @ 25°C)

Regarding aging rate: Capacitance measurements (including tolerance) are indexed to a referee time of 48 or 1,000 hours. Please refer to a part number specific datasheet for referee time details.

To obtain IR limit, divide $M\Omega\text{-}\mu\text{F}$ value by the capacitance and compare to $G\Omega$ limit. Select the lower of the two limits.

Capacitance and dissipation factor (DF) measured under the following conditions:

1 kHz ±50 Hz and 1.0 ±0.2 Vrms if capacitance ≤ 10 μF

120 Hz ±10 Hz and 0.5 ±0.1 Vrms if capacitance > 10 μF

Note: When measuring capacitance it is important to ensure the set voltage level is held constant. The HP4284 and Agilent E4980 have a feature known as Automatic Level Control (ALC). The ALC feature should be switched to "ON."

Post Environmental Limits

High Temperature Life, Biased Humidity, Moisture Resistance					
Dielectric	Rated DC Voltage	Capacitance Value	Dissipation Factor (Maximum %)	Capacitance Shift	Insulation Resistance
X5R	> 25	All	3.0	±20%	10% of Initial Limit
	25		7.5		
	< 25	< 0.56 μF	7.5		
	< 25	≥ 0.56 μF	12.0		

Dissipation Factor Limit Table

Rated DC Voltage	Capacitance	Dissipation Factor
50 – 200 V	All	3%
25 V	All	5%
< 25 V	< 0.56 μF	5%
< 25 V	≥ 0.56 μF	10%

Insulation Resistance Limit Table

EIA Case Size	1,000 Megohm Microfarads or 100 GΩ	500 Megohm Microfarads or 10 GΩ
0201	N/A	ALL
0402	< 0.012 μF	≥ 0.012 μF
0603	< 0.047 μF	≥ 0.047 μF
0805	< 0.047 μF	≥ 0.047 μF
1206	< 0.22 μF	≥ 0.22 μF
1210	< 0.39 μF	≥ 0.39 μF

Table 1 – Capacitance Range/Selection Waterfall (1005 – 1210 Case Sizes)

Cap	Cap Code	Case Size / Series		C0201C				C0402C					C0603C					C0805C					C1206C					C1210C											
		Voltage Code		7	9	8	4	7	9	8	4	3	5	7	9	8	4	3	5	7	9	8	4	3	5	9	8	4	3	5	9	8	4	3	6	5			
		Rated Voltage (VDC)		4	6.3	10	16	4	6.3	10	16	25	50	4	6.3	10	16	25	50	4	6.3	10	16	25	50	6.3	10	16	25	50	6.3	10	16	25	35	50			
		Cap Tolerance		Product Availability and Chip Thickness Codes – See Table 2 for Chip Thickness Dimensions																																			
10,000 pF	103	K	M	AB	AB	AB	AB	BB	BB	BB	BB																												
12,000 pF	123	K	M					BB	BB	BB	BB																												
15,000 pF	153	K	M					BB	BB	BB	BB																												
18,000 pF	183	K	M					BB	BB	BB	BB																												
22,000 pF	223	K	M					BB	BB	BB	BB																												
27,000 pF	273	K	M					BB	BB	BB	BB																												
33,000 pF	333	K	M					BB	BB	BB	BB																												
39,000 pF	393	K	M					BB	BB	BB	BB																												
47,000 pF	473	K	M					BB	BB	BB	BB																												
56,000 pF	563	K	M					BB	BB	BB	BB																												
68,000 pF	683	K	M					BB	BB	BB	BB																												
82,000 pF	823	K	M					BB	BB	BB	BB																												
0.10 µF	104	K	M	AB	AB			BB	BB	BB	BB																												
0.22 µF	224	K	M					BB	BB																														
0.27 µF	274	K	M																																				
0.33 µF	334	K	M																																				
0.39 µF	394	K	M																																				
0.47 µF	474	K	M					BB	BB																														
0.56 µF	564	K	M																																				
0.68 µF	684	K	M																																				
0.82 µF	824	K	M																																				
1.0 µF	105	K	M					BB	BB	BB																													
1.2 µF	125	K	M																																				
1.5 µF	155	K	M																																				
1.8 µF	185	K	M																																				
2.2 µF	225	K	M					BB'	BB'	BB'																													
2.7 µF	275	K	M																																				
3.3 µF	335	K	M					BB'																															
3.9 µF	395	K	M																																				
4.7 µF	475	K	M					BC'																															
5.6 µF	565	K	M																																				
6.8 µF	685	K	M																																				
8.2 µF	825	K	M																																				
10 µF	106	K	M																																				
12 µF	126	K	M																																				
15 µF	156	K	M																																				
18 µF	186	K	M																																				
22 µF	226	K	M																																				
47 µF	476	K	M																																				
100 µF	107	K	M																																				
Cap	Cap Code	Rated Voltage (VDC)		4	6.3	10	16	4	6.3	10	16	25	50	4	6.3	10	16	25	50	4	6.3	10	16	25	50	6.3	10	16	25	50	6.3	10	16	25	35	50			
		Voltage Code		7	9	8	4	7	9	8	3	5	4	7	9	8	4	3	5	7	9	8	4	3	5	9	8	4	3	5	9	8	4	3	6	5			
		Case Size / Series		C0201C				C0402C					C0603C					C0805C					C1206C					C1210C											

xx¹ Available only in M tolerance.

Table 2 – Chip Thickness/Packaging Quantities

Thickness Code	Case Size	Thickness ± Range (mm)	Paper Quantity		Plastic Quantity	
			7" Reel	13" Reel	7" Reel	13" Reel
AB	0201	0.30 ± 0.03	15,000	0	0	0
BB	0402	0.50 ± 0.05	10,000	50,000	0	0
BC	0402	0.50 ± 0.10	10,000	50,000	0	0
CC	0603	0.80 ± 0.10	4,000	10,000	0	0
DC	0805	0.78 ± 0.10	4,000	10,000	0	0
DD	0805	0.90 ± 0.10	4,000	10,000	0	0
DL	0805	0.95 ± 0.10	0	0	4,000	10,000
DE	0805	1.00 ± 0.10	0	0	2,500	10,000
DF	0805	1.10 ± 0.10	0	0	2,500	10,000
DG	0805	1.25 ± 0.15	0	0	2,500	10,000
DH	0805	1.25 ± 0.20	0	0	2,500	10,000
EB	1206	0.78 ± 0.10	4,000	10,000	4,000	10,000
EK	1206	0.80 ± 0.10	0	0	2,000	8,000
EC	1206	0.90 ± 0.10	0	0	4,000	10,000
ED	1206	1.00 ± 0.10	0	0	2,500	10,000
EE	1206	1.10 ± 0.10	0	0	2,500	10,000
EF	1206	1.20 ± 0.15	0	0	2,500	10,000
EG	1206	1.60 ± 0.15	0	0	2,000	8,000
EH	1206	1.60 ± 0.20	0	0	2,000	8,000
FD	1210	0.95 ± 0.10	0	0	4,000	10,000
FE	1210	1.00 ± 0.10	0	0	2,500	10,000
FF	1210	1.10 ± 0.10	0	0	2,500	10,000
FG	1210	1.25 ± 0.15	0	0	2,500	10,000
FH	1210	1.55 ± 0.15	0	0	2,000	8,000
FJ	1210	1.85 ± 0.20	0	0	2,000	8,000
FT	1210	1.90 ± 0.20	0	0	1,500	4,000
FK	1210	2.10 ± 0.20	0	0	2,000	8,000
FS	1210	2.50 ± 0.30	0	0	1,000	4,000
Thickness Code	Case Size	Thickness ± Range (mm)	7" Reel	13" Reel	7" Reel	13" Reel
			Paper Quantity		Plastic Quantity	

Package quantity based on finished chip thickness specifications.

Table 3 – Chip Capacitor Land Pattern Design Recommendations per IPC–7351

EIA Size Code	Metric Size Code	Density Level A: Maximum (Most) Land Protrusion (mm)					Density Level B: Median (Nominal) Land Protrusion (mm)					Density Level C: Minimum (Least) Land Protrusion (mm)				
		C	Y	X	V1	V2	C	Y	X	V1	V2	C	Y	X	V1	V2
0201	0603	0.38	0.56	0.52	1.80	1.00	0.33	0.46	0.42	1.50	0.80	0.28	0.36	0.32	1.20	0.60
0402	1005	0.50	0.72	0.72	2.20	1.20	0.45	0.62	0.62	1.90	1.00	0.40	0.52	0.52	1.60	0.80
0603	1608	0.90	1.15	1.10	4.00	2.10	0.80	0.95	1.00	3.10	1.50	0.60	0.75	0.90	2.40	1.20
0805	2012	1.00	1.35	1.55	4.40	2.60	0.90	1.15	1.45	3.50	2.00	0.75	0.95	1.35	2.80	1.70
1206	3216	1.60	1.35	1.90	5.60	2.90	1.50	1.15	1.80	4.70	2.30	1.40	0.95	1.70	4.00	2.00
1210	3225	1.60	1.35	2.80	5.65	3.80	1.50	1.15	2.70	4.70	3.20	1.40	0.95	2.60	4.00	2.90
1210 ¹	3225	1.50	1.60	2.90	5.60	3.90	1.40	1.40	2.80	4.70	3.30	1.30	1.20	2.70	4.00	3.00

¹ Only for capacitance values $\geq 22 \mu\text{F}$

Density Level A: For low-density product applications. Recommended for wave solder applications and provides a wider process window for reflow solder processes. KEMET only recommends wave soldering of EIA 0603, 0805 and 1206 case sizes.

Density Level B: For products with a moderate level of component density. Provides a robust solder attachment condition for reflow solder processes.

Density Level C: For high component density product applications. Before adapting the minimum land pattern variations the user should perform qualification testing based on the conditions outlined in IPC Standard 7351 (IPC–7351).

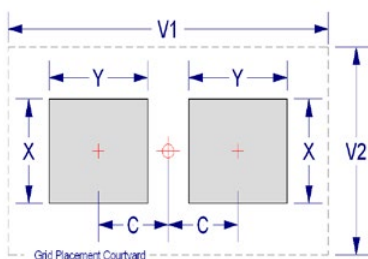

Soldering Process

Recommended Soldering Technique:

- Solder wave or solder reflow for EIA case sizes 0603, 0805 and 1206
- All other EIA case sizes are limited to solder reflow only

Recommended Soldering Profile:

- KEMET recommends following the guidelines outlined in IPC/JEDEC J–STD–020

Table 4 – Performance & Reliability: Test Methods and Conditions

Stress	Reference	Test or Inspection Method
Terminal Strength	JIS-C-6429	Appendix 1, Note: Force of 1.8 kg for 60 seconds.
Board Flex	JIS-C-6429	Appendix 2, Note: Standard termination system – 2.0 mm (minimum) for all except 3 mm for COG. Flexible termination system – 3.0 mm (minimum).
Solderability	J-STD-002	Magnification 50 X. Conditions:
		a) Method B, 4 hours @ 155°C, dry heat @ 235°C
		b) Method B @ 215°C category 3
		c) Method D, category 3 @ 260°C
Temperature Cycling	JESD22 Method JA-104	1,000 Cycles (-55°C to +125°C). Measurement at 24 hours +/- 2 hours after test conclusion.
Biased Humidity	MIL-STD-202 Method 103	Load Humidity: 1,000 hours 85°C/85% RH and rated voltage. Add 100 K ohm resistor. Measurement at 24 hours +/- 2 hours after test conclusion.
		Low Volt Humidity: 1,000 hours 85°C/85% RH and 1.5 V. Add 100 K ohm resistor. Measurement at 24 hours +/- 2 hours after test conclusion.
Moisture Resistance	MIL-STD-202 Method 106	t = 24 hours/cycle. Steps 7a and 7b not required. Unpowered. Measurement at 24 hours +/- 2 hours after test conclusion.
Thermal Shock	MIL-STD-202 Method 107	-55°C/+125°C. Note: Number of cycles required – 300, maximum transfer time – 20 seconds, dwell time – 15 minutes. Air – Air.
High Temperature Life	MIL-STD-202 Method 108 /EIA-198	1,000 hours at 125°C (85°C for X5R, Z5U and Y5V) with 2 X rated voltage applied.
Storage Life	MIL-STD-202 Method 108	150°C, 0 VDC for 1,000 hours.
Vibration	MIL-STD-202 Method 204	5 g's for 20 min., 12 cycles each of 3 orientations. Note: Use 8" X 5" PCB 0.031" thick 7 secure points on one long side and 2 secure points at corners of opposite sides. Parts mounted within 2" from any secure point. Test from 10 – 2,000 Hz
Mechanical Shock	MIL-STD-202 Method 213	Figure 1 of Method 213, Condition F.
Resistance to Solvents	MIL-STD-202 Method 215	Add aqueous wash chemical, OKEM Clean or equivalent.

Storage and Handling

Ceramic chip capacitors should be stored in normal working environments. While the chips themselves are quite robust in other environments, solderability will be degraded by exposure to high temperatures, high humidity, corrosive atmospheres, and long term storage. In addition, packaging materials will be degraded by high temperature– reels may soften or warp and tape peel force may increase. KEMET recommends that maximum storage temperature not exceed 40°C and maximum storage humidity not exceed 70% relative humidity. Temperature fluctuations should be minimized to avoid condensation on the parts and atmospheres should be free of chlorine and sulfur bearing compounds. For optimized solderability chip stock should be used promptly, preferably within 1.5 years of receipt.

Construction

Reference	Item	Material
A	Termination System	Finish
B		Barrier Layer
C		Base Metal
D	Inner Electrode	Ni
E	Dielectric Material	BaTiO ₃

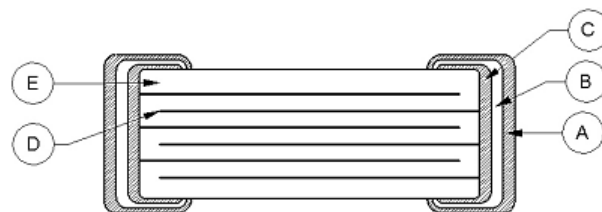

Note: Image is exaggerated in order to clearly identify all components of construction.

Surface Mount Multilayer Ceramic Chip Capacitors (SMD MLCCs)
Z5U Dielectric, 50 – 100 VDC (Commercial Grade)

Overview

KEMET’s Z5U dielectric features an 85°C maximum operating temperature and is considered “general-purpose.” The Electronics Components, Assemblies & Materials Association (EIA) characterizes Z5U dielectric as a Class III material. Components of this classification are fixed, ceramic dielectric capacitors suited for bypass and decoupling or other

applications in which dielectric losses, high insulation resistance and capacitance stability are not of major importance. Z5U exhibits a predictable change in capacitance with respect to time and voltage and displays wide variations in capacitance with reference to ambient temperature. Capacitance change is limited to +22%, -56% from +10°C to +85°C.

Benefits

- +10°C to +85°C operating temperature range
- Pb-Free and RoHS Compliant
- EIA 0805, 1206, 1210, 1812, 1825, and 2225 case sizes
- DC voltage ratings of 50 and 100 V
- Capacitance offerings ranging from 6,800 pF to 2.2 µF
- Available capacitance tolerances of ±20% and +80%/ -20%
- Non-polar device, minimizing installation concerns
- 100% pure matte tin-plated termination finish allowing for excellent solderability

Applications

Typical applications include limited temperature, decoupling and bypass.

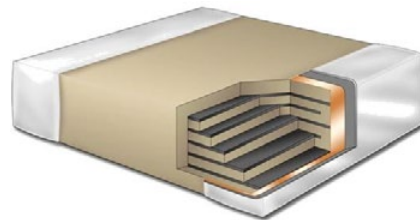

Ordering Information

C	1825	C	225	M	5	U	A	C	TU
Ceramic	Case Size (L" x W")	Specification/ Series	Capacitance Code (pF)	Capacitance Tolerance	Voltage	Dielectric	Failure Rate/ Design	Termination Finish ²	Packaging/Grade (C-Spec) ²
	0805 1206 1210 1812 1825 2225	C = Standard	2 Significant Digits + Number of Zeros	M = ±20% Z = +80%/ -20	5 = 50 V 1 = 100 V	U = Z5U	A = N/A	C = 100% Matte Sn	Blank = Bulk TU = 7" Reel Unmarked TM = 7" Reel Marked

¹ Additional termination finish options may be available. Contact KEMET for details.

² Additional reeling or packaging options may be available. Contact KEMET for details.

Dimensions – Millimeters (Inches)

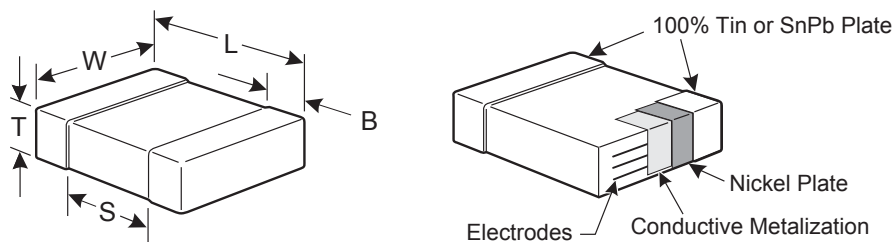

EIA Size Code	Metric Size Code	L Length	W Width	T Thickness	B Bandwidth	S Separation Minimum	Mounting Technique
0805	2012	2.00 (.079) ± 0.20 (.008)	1.25 (.049) ± 0.20 (.008)	See Table 2 for Thickness	0.50 (0.02) ± 0.25 (.010)	0.75 (.030)	Solder Wave or Solder Reflow
1206	3216	3.20 (.126) ± 0.20 (.008)	1.60 (.063) ± 0.20 (.008)		0.50 (0.02) ± 0.25 (.010)	N/A	
1210	3225	3.20 (.126) ± 0.20 (.008)	2.50 (.098) ± 0.20 (.008)		0.50 (0.02) ± 0.25 (.010)		Solder Reflow Only
1812	4532	4.50 (.177) ± 0.30 (.012)	3.20 (.126) ± 0.30 (.012)		0.60 (.024) ± 0.35 (.014)		
1825	4564	4.50 (.177) ± 0.30 (.012)	6.40 (.252) ± 0.40 (.016)		0.60 (.024) ± 0.35 (.014)		
2225	5664	5.60 (.220) ± 0.40 (.016)	6.40 (.248) ± 0.40 (.016)		0.60 (.024) ± 0.35 (.014)		

Qualification/Certification

Commercial Grade products are subject to internal qualification. Details regarding test methods and conditions are referenced in Table 4, Performance & Reliability.

Environmental Compliance

Pb-Free and RoHS Compliant.



RoHS Compliant

Electrical Parameters/Characteristics

Item	Parameters/Characteristics
Operating Temperature Range	-10°C to +85°C
Capacitance Change with Reference to +25°C and 0 VDC Applied (TCC)	+22%, -56%
Aging Rate (Maximum % Capacitance Loss/Decade Hour)	7.0%
Dielectric Withstanding Voltage (DWV)	250% of rated voltage (5 ±1 seconds and charge/discharge not exceeding 50 mA)
Dissipation Factor (DF) Maximum Limit @ 25°C	4.0%
Insulation Resistance (IR) Limit @ 25°C	100 megohm microfarads or 10 GΩ (Rated voltage applied for 120 ±5 seconds @ 25°C)

Regarding aging rate: Capacitance measurements (including tolerance) are indexed to a referee time of 48 or 1,000 hours. Please refer to a part number specific datasheet for referee time details.

To obtain IR limit, divide MΩ-μF value by the capacitance and compare to GΩ limit. Select the lower of the two limits.

Capacitance and Dissipation Factor (DF) measured under the following conditions:

1 kHz ±50 Hz and 1.0 ±0.2 Vrms if capacitance ≤ 10 μF

120 Hz ±10 Hz and 0.5 ±0.1 Vrms if capacitance > 10 μF

Note: When measuring capacitance it is important to ensure the set voltage level is held constant. The HP4284 and Agilent E4980 have a feature known as Automatic Level Control (ALC). The ALC feature should be switched to "ON."

Post Environmental Limits

High Temperature Life, Biased Humidity, Moisture Resistance					
Dielectric	Rated DC Voltage	Capacitance Value	Dissipation Factor (Maximum %)	Capacitance Shift	Insulation Resistance
Z5U	> 25	All	5.0	±30%	10% of Initial Limit
	25		7.5		

Table 1 – Capacitance Range/Selection Waterfall (0805 – 2225 Case Sizes)

Capacitance	Capacitance Code	Case Size / Series		C0805C		C1206C		C1210C		C1812C		C1825C		C2225C			
		Voltage Code		5	1	5	1	5	1	5	1	5	1	5	1		
		Rated Voltage (VDC)		50	100	50	100	50	100	50	100	50	100	50	100	50	100
		Capacitance Tolerance		Product Availability and Chip Thickness Codes See Table 2 for Chip Thickness Dimensions													
6,800 pF	682	M	Z	DC	DC												
8,200 pF	822	M	Z	DC	DC												
10,000 pF	103	M	Z	DC	DC	EB	EB										
12,000 pF	123	M	Z	DC		EB	EB										
15,000 pF	153	M	Z	DC		EB	EB										
18,000 pF	183	M	Z	DC		EB	EB										
22,000 pF	223	M	Z	DC		EB	EB										
27,000 pF	273	M	Z	DC		EB	EB										
33,000 pF	333	M	Z	DC		EB	EB										
39,000 pF	393	M	Z	DC		EB	EC										
47,000 pF	473	M	Z	DC		EB	EC	FB	FB								
56,000 pF	563	M	Z	DD		EB	EB	FB	FB								
68,000 pF	683	M	Z	DD		EB	EB	FB	FB								
82,000 pF	823	M	Z	DD		EB	EB	FB	FC	GB	GB						
0.10 uF	104	M	Z	DC		EB	EB	FB	FD	GB	GB						
0.12 uF	124	M	Z			EC		FB	FD	GB	GB						
0.15 uF	154	M	Z			EC		FC	FD	GB	GB						
0.18 uF	184	M	Z			EC		FC		GB		HB	HB				
0.22 uF	224	M	Z			EC		FC		GB		HB	HB				
0.27 uF	274	M	Z					FC		GB		HB	HB				
0.33 uF	334	M	Z					FC		GB		HB	HB	KB	KC		
0.39 uF	394	M	Z					FD		GB		HB	HB	KB	KC		
0.47 uF	474	M	Z					FD		GB		HB		KB	KC		
0.56 uF	564	M	Z					FD		GC		HB		KB			
0.68 uF	684	M	Z					FD		GC		HB		KB			
0.82 uF	824	M	Z					FF		GE		HB		KB			
1.0 uF	105	M	Z					FH		GE		HB		KB			
1.2 uF	125	M	Z									HB		KB			
1.5 uF	155	M	Z									HC		KC			
1.8 uF	185	M	Z									HD		KD			
2.2 uF	225	M	Z									HF		KD			
Capacitance	Capacitance Code	Rated Voltage (VDC)		50	100	50	100	50	100	50	100	50	100	50	100		
		Voltage Code		5	1	5	1	5	1	5	1	5	1	5	1		
		Case Size / Series		C0805C		C1206C		C1210C		C1812C		C1825C		C2225C			

Table 2 – Chip Thickness/Packaging Quantities

Thickness Code	Case Size	Thickness ± Range (mm)	Paper Quantity		Plastic Quantity	
			7" Reel	13" Reel	7" Reel	13" Reel
DC	0805	0.78 ± 0.10	4,000	10,000	0	0
DD	0805	0.90 ± 0.10	4,000	10,000	0	0
EB	1206	0.78 ± 0.10	4,000	10,000	4,000	10,000
EC	1206	0.90 ± 0.10	0	0	4,000	10,000
FB	1210	0.78 ± 0.10	0	0	4,000	10,000
FC	1210	0.90 ± 0.10	0	0	4,000	10,000
FD	1210	0.95 ± 0.10	0	0	4,000	10,000
FF	1210	1.10 ± 0.10	0	0	2,500	10,000
FH	1210	1.55 ± 0.15	0	0	2,000	8,000
GB	1812	1.00 ± 0.10	0	0	1,000	4,000
GC	1812	1.10 ± 0.10	0	0	1,000	4,000
GE	1812	1.30 ± 0.10	0	0	1,000	4,000
HB	1825	1.10 ± 0.15	0	0	1,000	4,000
HC	1825	1.15 ± 0.15	0	0	1,000	4,000
HD	1825	1.30 ± 0.15	0	0	1,000	4,000
HF	1825	1.50 ± 0.15	0	0	1,000	4,000
KB	2225	1.00 ± 0.15	0	0	1,000	4,000
KC	2225	1.10 ± 0.15	0	0	1,000	4,000
KD	2225	1.30 ± 0.15	0	0	1,000	4,000
Thickness Code	Case Size	Thickness ± Range (mm)	7" Reel	13" Reel	7" Reel	13" Reel
			Paper Quantity		Plastic Quantity	

Package quantity based on finished chip thickness specifications.

Table 3 – Chip Capacitor Land Pattern Design Recommendations per IPC-7351

EIA Size Code	Metric Size Code	Density Level A: Maximum (Most) Land Protrusion (mm)					Density Level B: Median (Nominal) Land Protrusion (mm)					Density Level C: Minimum (Least) Land Protrusion (mm)				
		C	Y	X	V1	V2	C	Y	X	V1	V2	C	Y	X	V1	V2
0805	2012	1.00	1.35	1.55	4.40	2.60	0.90	1.15	1.45	3.50	2.00	0.75	0.95	1.35	2.80	1.70
1206	3216	1.60	1.35	1.90	5.60	2.90	1.50	1.15	1.80	4.70	2.30	1.40	0.95	1.70	4.00	2.00
1210	3225	1.60	1.35	2.80	5.65	3.80	1.50	1.15	2.70	4.70	3.20	1.40	0.95	2.60	4.00	2.90
1210 ¹	3225	1.50	1.60	2.90	5.60	3.90	1.40	1.40	2.80	4.70	3.30	1.30	1.20	2.70	4.00	3.00
1812	4532	2.15	1.60	3.60	6.90	4.60	2.05	1.40	3.50	6.00	4.00	1.95	1.20	3.40	5.30	3.70
1825	4564	2.15	1.60	6.90	6.90	7.90	2.05	1.40	6.80	6.00	7.30	1.95	1.20	6.70	5.30	7.00
2225	5664	2.70	1.70	6.90	8.10	7.90	2.60	1.50	6.80	7.20	7.30	2.50	1.30	6.70	6.50	7.00

¹ Only for capacitance values $\geq 22 \mu\text{F}$

Density Level A: For low-density product applications. Recommended for wave solder applications and provides a wider process window for reflow solder processes. KEMET only recommends wave soldering of EIA 0603, 0805, and 1206 case sizes.

Density Level B: For products with a moderate level of component density. Provides a robust solder attachment condition for reflow solder processes.

Density Level C: For high component density product applications. Before adapting the minimum land pattern variations the user should perform qualification testing based on the conditions outlined in IPC Standard 7351 (IPC-7351).

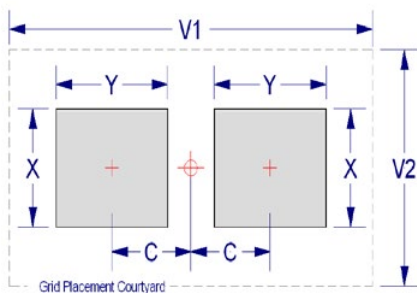

Soldering Process

Recommended Soldering Technique:

- Solder wave or solder reflow for EIA case sizes 0603, 0805, and 1206
- All other EIA case sizes are limited to solder reflow only

Recommended Soldering Profile:

- KEMET recommends following the guidelines outlined in IPC/JEDEC J-STD-020

Table 4 – Performance & Reliability: Test Methods and Conditions

Stress	Reference	Test or Inspection Method
Terminal Strength	JIS-C-6429	Appendix 1, Note: Force of 1.8 kg for 60 seconds.
Board Flex	JIS-C-6429	Appendix 2, Note: Standard termination system – 2.0 mm (minimum) for all except 3 mm for COG. Flexible termination system – 3.0 mm (minimum).
Solderability	J-STD-002	Magnification 50 X. Conditions:
		a) Method B, 4 hours @ 155°C, dry heat @ 235°C
		b) Method B @ 215°C category 3
		c) Method D, category 3 @ 260°C
Temperature Cycling	JESD22 Method JA-104	1,000 Cycles (-55°C to +125°C). Measurement at 24 hours +/- 2 hours after test conclusion.
Biased Humidity	MIL-STD-202 Method 103	Load Humidity: 1,000 hours 85°C/85% RH and rated voltage. Add 100 K ohm resistor. Measurement at 24 hours +/- 2 hours after test conclusion.
		Low Volt Humidity: 1,000 hours 85°C/85% RH and 1.5 V. Add 100 K ohm resistor. Measurement at 24 hours +/- 2 hours after test conclusion.
Moisture Resistance	MIL-STD-202 Method 106	t = 24 hours/cycle. Steps 7a and 7b not required. Unpowered. Measurement at 24 hours +/- 2 hours after test conclusion.
Thermal Shock	MIL-STD-202 Method 107	-55°C/+125°C. Note: Number of cycles required – 300, maximum transfer time – 20 seconds, dwell time – 15 minutes. Air – Air.
High Temperature Life	MIL-STD-202 Method 108 /EIA-198	1,000 hours at 125°C (85°C for X5R, Z5U and Y5V) with 2 X rated voltage applied.
Storage Life	MIL-STD-202 Method 108	150°C, 0 VDC for 1,000 hours.
Vibration	MIL-STD-202 Method 204	5 g's for 20 min., 12 cycles each of 3 orientations. Note: Use 8" X 5" PCB 0.031" thick 7 secure points on one long side and 2 secure points at corners of opposite sides. Parts mounted within 2" from any secure point. Test from 10 – 2,000 Hz
Mechanical Shock	MIL-STD-202 Method 213	Figure 1 of Method 213, Condition F.
Resistance to Solvents	MIL-STD-202 Method 215	Add aqueous wash chemical, OKEM Clean or equivalent.

Storage and Handling

Ceramic chip capacitors should be stored in normal working environments. While the chips themselves are quite robust in other environments, solderability will be degraded by exposure to high temperatures, high humidity, corrosive atmospheres, and long term storage. In addition, packaging materials will be degraded by high temperature– reels may soften or warp and tape peel force may increase. KEMET recommends that maximum storage temperature not exceed 40°C and maximum storage humidity not exceed 70% relative humidity. Temperature fluctuations should be minimized to avoid condensation on the parts and atmospheres should be free of chlorine and sulfur bearing compounds. For optimized solderability chip stock should be used promptly, preferably within 1.5 years of receipt.

Construction

Reference	Item		Material
A	Termination System	Finish	100% Matte Sn
B		Barrier Layer	Ni
C		Base Metal	Cu
D	Inner Electrode		Ni
E	Dielectric Material		BaTiO ₃

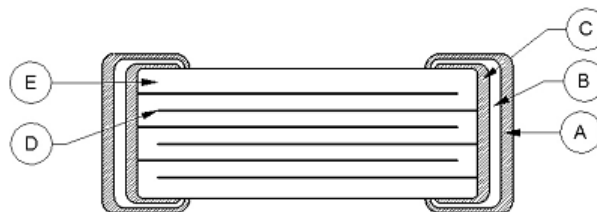

Note: Image is exaggerated in order to clearly identify all components of construction.

Surface Mount Multilayer Ceramic Chip Capacitors (SMD MLCCs)
Y5V Dielectric, 6.3 – 50 VDC (Commercial Grade)

Overview

KEMET's Y5V dielectric features an 85°C maximum operating temperature and is considered "general-purpose." The Electronics Components, Assemblies & Materials Association (EIA) characterizes Y5V dielectric as a Class III material. Components of this classification are fixed, ceramic dielectric capacitors suited for bypass and decoupling or other

applications in which dielectric losses, high insulation resistance and capacitance stability are not of major importance. Y5V exhibits a predictable change in capacitance with respect to time and voltage and displays wide variations in capacitance with reference to ambient temperature. Capacitance change is limited to +22%, -82% from -30°C to +85°C.

Benefits

- -30°C to +85°C operating temperature range
- Pb-Free and RoHS Compliant
- EIA 0402, 0603, 0805, 1206, and 1210 case sizes
- DC voltage ratings of 6.3 V, 10 V, 16 V, 25 V, and 50 V
- Capacitance offerings ranging from 0.022 µF to 22 µF
- Available capacitance tolerance of +80%/ -20%
- Non-polar device, minimizing installation concerns
- 100% pure matte tin-plated termination finish that allowing for excellent solderability

Applications

Typical applications include limited temperature, decoupling and bypass.

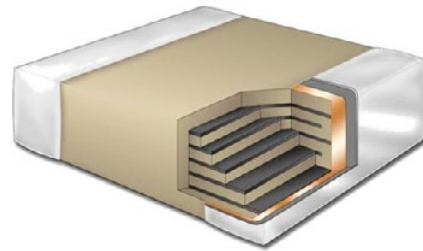

Ordering Information

C	1210	C	226	Z	4	V	A	C	TU
Ceramic	Case Size (L" x W")	Specification/ Series	Capacitance Code (pF)	Capacitance Tolerance	Voltage	Dielectric	Failure Rate/ Design	Termination Finish ¹	Packaging/Grade (C-Spec) ²
	0402 0603 0805 1206 1210	C = Standard	2 Significant Digits + Number of Zeros	Z = +80%/ -20%	9 = 6.3 V 8 = 10 V 4 = 16 V 3 = 25 V 5 = 50 V	V = Y5V	A = N/A	C = 100% Matte Sn	Blank = Bulk TU = 7" Reel Unmarked

¹ Additional termination finish options may be available. Contact KEMET for details.

² Additional reeling or packaging options may be available. Contact KEMET for details.

Dimensions – Millimeters (Inches)

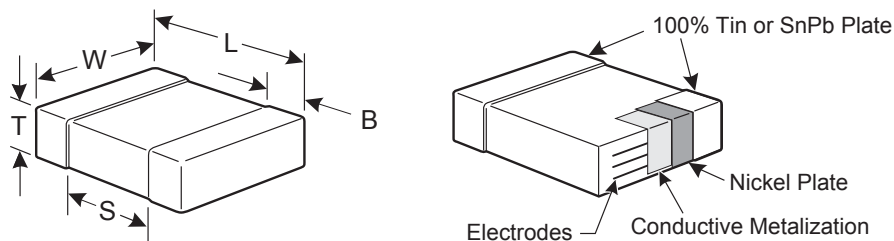

EIA Size Code	Metric Size Code	L Length	W Width	T Thickness	B Bandwidth	S Separation Minimum	Mounting Technique
0402	1005	1.00 (.040) ± 0.05 (.002)	0.50 (.020) ± 0.05 (.002)	See Table 2 for Thickness	0.30 (.012) ± 0.10 (.004)	0.30 (.012)	Solder Reflow Only
0603	1608	1.60 (.063) ± 0.15 (.006)	0.80 (.032) ± 0.15 (.006)		0.35 (.014) ± 0.15 (.006)	0.70 (.028)	Solder Wave or Solder Reflow
0805	2012	2.00 (.079) ± 0.20 (.008)	1.25 (.049) ± 0.20 (.008)		0.50 (0.02) ± 0.25 (.010)	0.75 (.030)	
1206	3216	3.20 (.126) ± 0.20 (.008)	1.60 (.063) ± 0.20 (.008)		0.50 (0.02) ± 0.25 (.010)	N/A	Solder Reflow Only
1210	3225	3.20 (.126) ± 0.20 (.008)	2.50 (.098) ± 0.20 (.008)		0.50 (0.02) ± 0.25 (.010)		

Qualification/Certification

Commercial Grade products are subject to internal qualification. Details regarding test methods and conditions are referenced in Table 4, Performance & Reliability.

Environmental Compliance

Pb-Free and RoHS Compliant.



RoHS Compliant

Electrical Parameters/Characteristics

Item	Parameters/Characteristics
Operating Temperature Range	-30°C to +85°C
Capacitance Change with Reference to +25°C and 0 VDC Applied (TCC)	+22%, -82%
Aging Rate (Maximum % Capacitance Loss/Decade Hour)	7.0%
Dielectric Withstanding Voltage (DWV)	250% of rated voltage (5 ±1 seconds and charge/discharge not exceeding 50 mA)
Dissipation Factor (DF) Maximum Limit @ 25°C	10% (6.3 and 10 V), 7% (16 and 25 V) and 5% (50 V)
Insulation Resistance (IR) Limit @ 25°C	See Insulation Resistance Limit Table (Rated voltage applied for 120 ±5 seconds @ 25°C)

Regarding aging rate: Capacitance measurements (including tolerance) are indexed to a reference time of 1,000 hours.

To obtain IR limit, divide $M\Omega \cdot \mu F$ value by the capacitance and compare to $G\Omega$ limit. Select the lower of the two limits.

Capacitance and Dissipation Factor (DF) measured under the following conditions:

1 kHz ±50 Hz and 1.0 ±0.2 Vrms

120 Hz ±10 Hz and 0.5 ±0.1 Vrms if capacitance >10 μF

Note: When measuring capacitance it is important to ensure the set voltage level is held constant. The HP4284 and Agilent E4980 have a feature known as Automatic Level Control (ALC). The ALC feature should be switched to "ON."

Post Environmental Limits

High Temperature Life, Biased Humidity, Moisture Resistance					
Dielectric	Rated DC Voltage	Capacitance Value	Dissipation Factor (Maximum %)	Capacitance Shift	Insulation Resistance
Y5V	> 25	All	7.5	±30%	10% of Initial Limit
	16/25		10.0		
	< 16		15.0		

Insulation Resistance Limit Table

EIA Case Size	100 Megohm Microfarads or 10 G Ω	50 Megohm Microfarads or 10 G Ω
All	≥ 16 V	≤ 10 V

Table 1 – Capacitance Range/Selection Waterfall (0402 – 1210 Case Sizes)

Capacitance	Cap Code	Case Size / Series		C0402C				C0603C				C0805C					C1206C					C1210C								
		Voltage Code		9	8	4	9	8	4	3	9	8	4	3	5	9	8	4	3	5	9	8	4	3	5					
		Rated Voltage (VDC)		6.3	10	16	6.3	10	16	25	6.3	10	16	25	50	6.3	10	16	25	50	6.3	10	16	25	50					
		Capacitance Tolerance		Product Availability and Chip Thickness Codes See Table 2 for Chip Thickness Dimensions																										
22,000 pF	223	M	Z	BB	BB	BB	CB	CB	CB	CB	DC	DC	DC	DC	DC															
27,000 pF	273	M	Z	BB	BB	BB	CB	CB	CB	CB	DC	DC	DC	DC	DC															
33,000 pF	333	M	Z	BB	BB	BB	CB	CB	CB	CB	DC	DC	DC	DC	DC															
39,000 pF	393	M	Z	BB	BB	BB	CB	CB	CB	CB	DD	DD	DD	DD	DD															
47,000 pF	473	M	Z	BB	BB	BB	CB	CB	CB	CB	DD	DD	DD	DD	DD															
56,000 pF	563	M	Z	BB	BB	BB	CB	CB	CB	CB	DD	DD	DD	DD	DD															
68,000 pF	683	M	Z	BB	BB	BB	CB	CB	CB	CB	DD	DD	DD	DD	DD															
82,000 pF	823	M	Z	BB	BB	BB	CB	CB	CB	CB	DD	DD	DD	DD	DD															
0.10 μF	104	M	Z	BB	BB	BB	CC	CC	CC	CC	DC	DC	DC	DC	DC															
0.12 μF	124	M	Z				CC	CC	CC	CC	DC	DC	DC	DC	DC															
0.15 μF	154	M	Z				CC	CC	CC	CC	DC	DC	DC	DC	DC															
0.18 μF	184	M	Z				CC	CC	CC	CC	DC	DC	DC	DC	DC															
0.22 μF	224	M	Z	BB			CC	CC	CC	CC	DC	DC	DC	DC	DG	EC	EC	EC	EC					FD	FD	FD	FD	FD		
0.27 μF	274	M	Z				CC	CC	CC	CC	DC	DC	DC	DC	DC	EB	EB	EB	EB					FD	FD	FD	FD	FD		
0.33 μF	334	M	Z				CC	CC	CC	CC	DC	DC	DC	DC	DC	EB	EB	EB	EB					FD	FD	FD	FD	FD		
0.39 μF	394	M	Z				CC	CC	CC		DC	DC	DC	DC		EB	EB	EB	EB					FD	FD	FD	FD	FD		
0.47 μF	474	M	Z	BB			CC	CC	CC		DC	DC	DC	DC		EC	EC	EC	EC					FD	FD	FD	FD	FD		
0.56 μF	564	M	Z				CC	CC			DD	DD	DD	DD		EB	EB	EB	EB					FD	FD	FD	FD	FD		
0.68 μF	684	M	Z				CC	CC			DE	DE	DE	DE		EB	EB	EB	EB					FD	FD	FD	FD	FD		
0.82 μF	824	M	Z				CC	CC			DG	DG	DG	DG		EB	EB	EB	EB					FF	FF	FF	FF	FF		
1.0 μF	105	M	Z	BB	BB		CC	CC	CC	CC	DG	DG	DG	DG	DG	EF	EF	EF	EG					FH	FH	FH	FH	FH		
1.2 μF	125	M	Z								DC	DC	DC			EC	EC	EC						FD	FD	FD				
1.5 μF	155	M	Z								DC	DC	DC			EC	EC	EC						FD	FD	FD				
1.8 μF	185	M	Z								DD	DD	DD			ED	ED	ED						FD	FD	FD				
2.2 μF	225	M	Z	BB	BB						DG	DG	DG			EE	EE	EE						FD	FD	FD				
3.3 μF	335	M	Z								DL	DL	DG			EH	EH	EF						FE	FE	FE				
4.7 μF	475	M	Z								DG	DG	DG			EM	EM	EM						FG	FG	FG				
5.6 μF	565	M	Z								DF	DF				EJ	EJ	EJ						FG	FG	FG				
6.8 μF	685	M	Z								DG	DG				EJ	EJ							FH	FH	FH				
10 μF	106	M	Z								DG	DG				EH	EH	EH	EH					FH	FH	FH				
15 μF	156	M	Z																					FH	FH	FH				
22 μF	226	M	Z													EH	EH							FT	FT	FS	FH			
Capacitance	Cap Code	Rated Voltage (VDC)		6.3	10	16	6.3	10	16	25	6.3	10	16	25	50	6.3	10	16	25	50	6.3	10	16	25	50	6.3	10	16	25	50
		Voltage Code		9	8	4	9	8	4	3	9	8	4	3	5	9	8	4	3	5	9	8	4	3	5	9	8	4	3	5
		Case Size / Series		C0402C			C0603C				C0805C					C1206C					C1210C									

Table 2 – Chip Thickness/Packaging Quantities

Thickness Code	Case Size	Thickness ± Range (mm)	Paper Quantity		Plastic Quantity	
			7" Reel	13" Reel	7" Reel	13" Reel
BB	0402	0.50 ± 0.05	10,000	50,000	0	0
CB	0603	0.80 ± 0.07	4,000	10,000	0	0
CC	0603	0.80 ± 0.10	4,000	10,000	0	0
DC	0805	0.78 ± 0.10	4,000	10,000	0	0
DD	0805	0.90 ± 0.10	4,000	10,000	0	0
DL	0805	0.95 ± 0.10	0	0	4,000	10,000
DE	0805	1.00 ± 0.10	0	0	2,500	10,000
DF	0805	1.10 ± 0.10	0	0	2,500	10,000
DG	0805	1.25 ± 0.15	0	0	2,500	10,000
EB	1206	0.78 ± 0.10	4,000	10,000	4,000	10,000
EC	1206	0.90 ± 0.10	0	0	4,000	10,000
ED	1206	1.00 ± 0.10	0	0	2,500	10,000
EE	1206	1.10 ± 0.10	0	0	2,500	10,000
EF	1206	1.20 ± 0.15	0	0	2,500	10,000
EM	1206	1.25 ± 0.15	0	0	2,500	10,000
EG	1206	1.60 ± 0.15	0	0	2,000	8,000
EH	1206	1.60 ± 0.20	0	0	2,000	8,000
EJ	1206	1.70 ± 0.20	0	0	2,000	8,000
FD	1210	0.95 ± 0.10	0	0	4,000	10,000
FE	1210	1.00 ± 0.10	0	0	2,500	10,000
FF	1210	1.10 ± 0.10	0	0	2,500	10,000
FG	1210	1.25 ± 0.15	0	0	2,500	10,000
FH	1210	1.55 ± 0.15	0	0	2,000	8,000
FT	1210	1.90 ± 0.20	0	0	1,500	4,000
FS	1210	2.50 ± 0.30	0	0	1,000	4,000
Thickness Code	Case Size	Thickness ± Range (mm)	7" Reel	13" Reel	7" Reel	13" Reel
			Paper Quantity		Plastic Quantity	

Package quantity based on finished chip thickness specifications.

Table 3 – Chip Capacitor Land Pattern Design Recommendations per IPC-7351

EIA Size Code	Metric Size Code	Density Level A: Maximum (Most) Land Protrusion (mm)					Density Level B: Median (Nominal) Land Protrusion (mm)					Density Level C: Minimum (Least) Land Protrusion (mm)				
		C	Y	X	V1	V2	C	Y	X	V1	V2	C	Y	X	V1	V2
0402	1005	0.50	0.72	0.72	2.20	1.20	0.45	0.62	0.62	1.90	1.00	0.40	0.52	0.52	1.60	0.80
0603	1608	0.90	1.15	1.10	4.00	2.10	0.80	0.95	1.00	3.10	1.50	0.60	0.75	0.90	2.40	1.20
0805	2012	1.00	1.35	1.55	4.40	2.60	0.90	1.15	1.45	3.50	2.00	0.75	0.95	1.35	2.80	1.70
1206	3216	1.60	1.35	1.90	5.60	2.90	1.50	1.15	1.80	4.70	2.30	1.40	0.95	1.70	4.00	2.00
1210	3225	1.60	1.35	2.80	5.65	3.80	1.50	1.15	2.70	4.70	3.20	1.40	0.95	2.60	4.00	2.90
1210 ¹	3225	1.50	1.60	2.90	5.60	3.90	1.40	1.40	2.80	4.70	3.30	1.30	1.20	2.70	4.00	3.00

¹ Only for capacitance values $\geq 22 \mu\text{F}$

Density Level A: For low-density product applications. Recommended for wave solder applications and provides a wider process window for reflow solder processes. KEMET only recommends wave soldering of EIA 0603, 0805, and 1206 case sizes.

Density Level B: For products with a moderate level of component density. Provides a robust solder attachment condition for reflow solder processes.

Density Level C: For high component density product applications. Before adapting the minimum land pattern variations the user should perform qualification testing based on the conditions outlined in IPC Standard 7351 (IPC-7351).

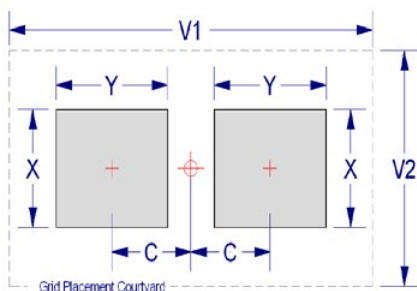

Soldering Process

Recommended Soldering Technique:

- Solder wave or solder reflow for EIA case sizes 0603, 0805, and 1206
- All other EIA case sizes are limited to solder reflow only

Recommended Soldering Profile:

- KEMET recommends following the guidelines outlined in IPC/JEDEC J-STD-020

Table 4 – Performance & Reliability: Test Methods and Conditions

Stress	Reference	Test or Inspection Method
Terminal Strength	JIS-C-6429	Appendix 1, Note: Force of 1.8 kg for 60 seconds.
Board Flex	JIS-C-6429	Appendix 2, Note: Standard termination system – 2.0 mm (minimum) for all except 3 mm for COG. Flexible termination system – 3.0 mm (minimum).
Solderability	J-STD-002	Magnification 50 X. Conditions:
		a) Method B, 4 hours @ 155°C, dry heat @ 235°C
		b) Method B @ 215°C category 3
		c) Method D, category 3 @ 260°C
Temperature Cycling	JESD22 Method JA-104	1,000 Cycles (-55°C to +125°C). Measurement at 24 hours +/- 2 hours after test conclusion.
Biased Humidity	MIL-STD-202 Method 103	Load Humidity: 1,000 hours 85°C/85% RH and rated voltage. Add 100 K ohm resistor. Measurement at 24 hours +/- 2 hours after test conclusion.
		Low Volt Humidity: 1,000 hours 85°C/85% RH and 1.5 V. Add 100 K ohm resistor. Measurement at 24 hours +/- 2 hours after test conclusion.
Moisture Resistance	MIL-STD-202 Method 106	t = 24 hours/cycle. Steps 7a and 7b not required. Unpowered. Measurement at 24 hours +/- 2 hours after test conclusion.
Thermal Shock	MIL-STD-202 Method 107	-55°C/+125°C. Note: Number of cycles required – 300, maximum transfer time – 20 seconds, dwell time – 15 minutes. Air – Air.
High Temperature Life	MIL-STD-202 Method 108 /EIA-198	1,000 hours at 125°C (85°C for X5R, Z5U and Y5V) with 2 X rated voltage applied.
Storage Life	MIL-STD-202 Method 108	150°C, 0 VDC for 1,000 hours.
Vibration	MIL-STD-202 Method 204	5 g's for 20 min., 12 cycles each of 3 orientations. Note: Use 8" X 5" PCB 0.031" thick 7 secure points on one long side and 2 secure points at corners of opposite sides. Parts mounted within 2" from any secure point. Test from 10 – 2,000 Hz
Mechanical Shock	MIL-STD-202 Method 213	Figure 1 of Method 213, Condition F.
Resistance to Solvents	MIL-STD-202 Method 215	Add aqueous wash chemical, OKEM Clean or equivalent.

Storage and Handling

Ceramic chip capacitors should be stored in normal working environments. While the chips themselves are quite robust in other environments, solderability will be degraded by exposure to high temperatures, high humidity, corrosive atmospheres, and long term storage. In addition, packaging materials will be degraded by high temperature– reels may soften or warp and tape peel force may increase. KEMET recommends that maximum storage temperature not exceed 40°C and maximum storage humidity not exceed 70% relative humidity. Temperature fluctuations should be minimized to avoid condensation on the parts and atmospheres should be free of chlorine and sulfur bearing compounds. For optimized solderability chip stock should be used promptly, preferably within 1.5 years of receipt.

Construction

Reference	Item	Material
A	Termination System	Finish
B		Barrier Layer
C		Base Metal
D	Inner Electrode	Ni
E	Dielectric Material	BaTiO ₃

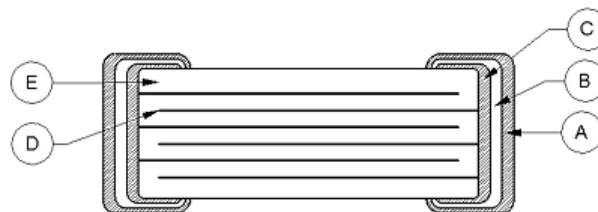

Note: Image is exaggerated in order to clearly identify all components of construction.

Capacitor Marking (Optional):

Laser marking option is not available on:

- COG, Ultra Stable X8R and Y5V dielectric devices
- EIA 0402 case size devices
- EIA 0603 case size devices with Flexible Termination option.
- KPS Commercial and Automotive grade stacked devices.

These capacitors are supplied unmarked only.

Capacitor Array, C0G Dielectric, 10 – 200 VDC (Commercial & Automotive Grade)

Overview

KEMET's Ceramic Chip Capacitor Array in C0G dielectric is an advanced passive technology where multiple capacitor elements are integrated into one common monolithic structure. Array technology promotes reduced placement costs and increased throughput. This is achieved by alternatively placing one device rather than two or four discrete devices. Use of capacitor arrays also saves board space which translates into increased board density and more functions per board. Arrays consume only a portion of the space required for standard chips resulting in savings in inventory and pick/place machine positions.

KEMET's C0G dielectric features a 125°C maximum operating temperature and is considered "stable." The Electronics

Industries Alliance (EIA) characterizes C0G dielectric as a Class I material. Components of this classification are temperature compensating and are suited for resonant circuit applications or those where Q and stability of capacitance characteristics are required. C0G exhibits no change in capacitance with respect to time and voltage and boasts a negligible change in capacitance with reference to ambient temperature. Capacitance change is limited to ± 30 ppm/°C from -55°C to +125°C.

KEMET automotive grade array capacitors meet the demanding Automotive Electronics Council's AEC-Q200 qualification requirements.

Benefits

- -55°C to +125°C operating temperature range
- Saves both circuit board and inventory space
- Reduces placement costs and increases throughput
- RoHS Compliant
- EIA 0508 (2-element) and 0612 (4-element) case sizes

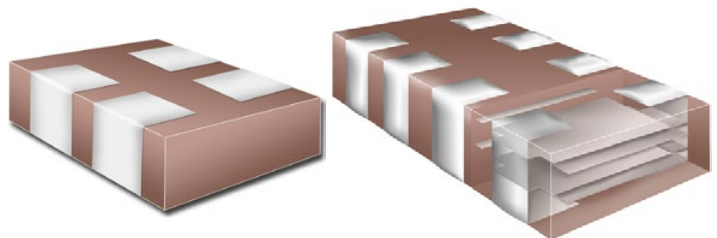

Ordering Information

CA	06	4	C	104	K	4	G	A	C	TU
Ceramic Array	Case Size (L" x W") ¹	Number of Capacitors	Specification/ Series	Capacitance Code (pF)	Capacitance Tolerance	Voltage	Dielectric	Failure Rate/ Design	Termination Finish ²	Packaging/Grade (C-Spec) ³
	05 = 0508 06 = 0612	2 = 2 4 = 4	C = Standard X = Flexible Termination	2 Significant Digits + Number of Zeros	J = $\pm 5\%$ K = $\pm 10\%$ M = $\pm 20\%$	8 = 10 V 4 = 16 V 3 = 25 V 5 = 50 V 1 = 100 V 2 = 200 V	G = C0G	A = N/A	C = 100% Matte Sn L = SnPb (5% minimum)	Blank = Bulk TU = 7" Reel Unmarked AUTO = Automotive Grade

¹ All previous reference to metric case dimension "1632" has been replaced with an inch standard reference of "0612". Please reference all new designs using the "0612" nomenclature. "CA064" replaces "C1632" in the ordering code.

² Additional termination finish options may be available. Contact KEMET for details.

^{2,3} SnPb termination finish option is not available on automotive grade product.

³ Additional reeling or packaging options may be available. Contact KEMET for details.

Dimensions – Millimeters (Inches)

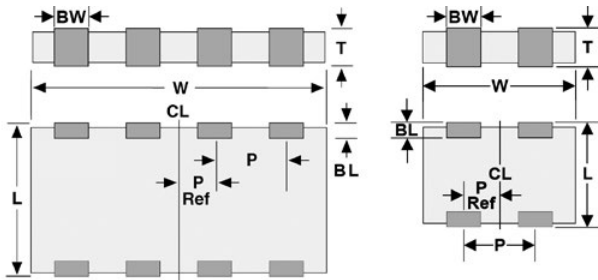

EIA Size Code	Metric Size Code	L Length	W Width	BW Bandwidth	BL Bandlength	T Thickness	P Pitch	P Reference
0508	1220	1.30 (0.051) ±0.15 (0.006)	2.10 (0.083) ±0.15 (0.006)	0.53 (0.021) ±0.08 (0.003)	0.30 (0.012) ±0.20 (0.008)	See Table 2 for Thickness	1.00 (0.039) ±0.10 (0.004)	0.50 (0.020) ±0.10 (0.004)
0612	1632	1.60 (0.063) ±0.20 (0.008)	3.20 (0.126) ±0.20 (0.008)	0.40 (0.016) ±0.20 (0.008)	0.30 (0.012) ±0.20 (0.008)		0.80 (0.031) ±0.10 (0.004)	0.40 (0.016) ±0.05 (0.002)

Benefits cont'd

- DC voltage ratings of 10 V, 16 V, 25 V, 50 V, 100 V, and 200 V
- Capacitance offerings ranging from 10 pF to 2,200 pF
- Available capacitance tolerances of ±5%, ±10%, and ±20%
- Non-polar device, minimizing installation concerns
- 100% pure matte tin-plated termination finish allowing for excellent solderability
- SnPb termination finish option available upon request (5% minimum)
- Flexible termination option available upon request
- Commercial and Automotive (AEC-Q200) grades available

Applications

Typical applications include those that can benefit from board area savings, cost savings and overall volumetric reduction such as telecommunications, computers, handheld devices and automotive.

Qualification/Certification

Commercial Grade products are subject to internal qualification. Details regarding test methods and conditions are referenced in Table 4, Performance & Reliability.

Automotive Grade products meet or exceed the requirements outlined by the Automotive Electronics Council. Details regarding test methods and conditions are referenced in document AEC-Q200, Stress Test Qualification for Passive Components. For additional information regarding the Automotive Electronics Council and AEC-Q200, please visit their website at www.aecouncil.com.

Environmental Compliance

Pb-Free and RoHS Compliant (excluding SnPb termination finish option).



RoHS Compliant

Electrical Parameters/Characteristics

Item	Parameters/Characteristics
Operating Temperature Range	-55°C to +125°C
Capacitance Change with Reference to +25°C and 0 VDC Applied (TCC)	±30 ppm/°C
Aging Rate (Maximum % Capacitance Loss/Decade Hour)	0%
Dielectric Withstanding Voltage (DWV)	250% of rated voltage (5 ±1 seconds and charge/discharge not exceeding 50 mA)
Dissipation Factor (DF) Maximum Limit @ 25°C	0.1%
Insulation Resistance (IR) Limit @ 25°C	1,000 megohm microfarads or 100 GΩ (Rated voltage applied for 120 ±5 seconds @ 25°C)

To obtain IR limit, divide MΩ-μF value by the capacitance and compare to GΩ limit. Select the lower of the two limits.

Capacitance and dissipation factor (DF) measured under the following conditions:

1 MHz ±100 kHz and 1.0 Vrms ±0.2 V if capacitance ≤ 1,000 pF

1 kHz ±50 Hz and 1.0 Vrms ±0.2 V if capacitance > 1,000 pF

Note: When measuring capacitance it is important to ensure the set voltage level is held constant. The HP4284 and Agilent E4980 have a feature known as Automatic Level Control (ALC). The ALC feature should be switched to "ON."

Post Environmental Limits

High Temperature Life, Biased Humidity, Moisture Resistance					
Dielectric	Rated DC Voltage	Capacitance Value	Dissipation Factor (Maximum %)	Capacitance Shift	Insulation Resistance
COG	All	All	0.5	0.3% or ±0.25 pF	10% of Initial Limit

Table 1 – Capacitance Range/Selection Waterfall (0508 – 0612 Case Sizes)

Capacitance	Capacitance Code	Case Size / Series			C0508 (CA052C 2-Cap Case Size)					C0612 (CA064C 4-Cap Case Size)					
		Voltage Code			8	4	3	5	1	8	4	3	5	1	2
		Rated Voltage (VDC)			10	16	25	50	100	10	16	25	50	100	200
		Capacitance Tolerance			Product Availability and Chip Thickness Codes See Table 2 for Chip Thickness Dimensions										
10 pF	100	J	K	M						MA	MA	MA	MA	MA	MA
12 pF	120	J	K	M						MA	MA	MA	MA	MA	MA
15 pF	150	J	K	M						MA	MA	MA	MA	MA	MA
18 pF	180	J	K	M						MA	MA	MA	MA	MA	MA
22 pF	220	J	K	M						MA	MA	MA	MA	MA	MA
27 pF	270	J	K	M						MA	MA	MA	MA	MA	MA
33 pF	330	J	K	M						MA	MA	MA	MA	MA	MA
39 pF	390	J	K	M						MA	MA	MA	MA	MA	MA
47 pF	470	J	K	M						MA	MA	MA	MA	MA	MA
56 pF	560	J	K	M						MA	MA	MA	MA	MA	MA
68 pF	680	J	K	M						MA	MA	MA	MA	MA	MA
82 pF	820	J	K	M						MA	MA	MA	MA	MA	MA
100 pF	101	J	K	M	PA	PA	PA	PA	PA	MA	MA	MA	MA	MA	MA
120 pF	121	J	K	M	PA	PA	PA	PA	PA	MA	MA	MA	MA	MA	MA
150 pF	151	J	K	M	PA	PA	PA	PA	PA	MA	MA	MA	MA	MA	MA
180 pF	181	J	K	M	PA	PA	PA	PA	PA	MA	MA	MA	MA	MA	
220 pF	221	J	K	M	PA	PA	PA	PA	PA	MA	MA	MA	MA	MA	
270 pF	271	J	K	M	PA	PA	PA	PA	PA	MA	MA	MA	MA	MA	
330 pF	331	J	K	M	PA	PA	PA	PA	PA	MA	MA	MA	MA	MA	
390 pF	391	J	K	M	PA	PA	PA	PA	PA	MA	MA	MA	MA	MA	
470 pF	471	J	K	M	PA	PA	PA	PA	PA	MA	MA	MA	MA		
560 pF	561	J	K	M	PA	PA	PA	PA	PA						
680 pF	681	J	K	M	PA	PA	PA	PA	PA						
820 pF	821	J	K	M	PA	PA	PA	PA	PA						
1,000 pF	102	J	K	M	PA	PA	PA	PA	PA						
1,100 pF	112	J	K	M	PA	PA	PA	PA	PA						
1,200 pF	122	J	K	M	PA	PA	PA	PA	PA						
1,300 pF	132	J	K	M	PA	PA	PA	PA	PA						
1,500 pF	152	J	K	M	PA	PA	PA	PA	PA						
1,600 pF	162	J	K	M	PA	PA	PA	PA	PA						
1,800 pF	182	J	K	M	PA	PA	PA	PA	PA						
2,000 pF	202	J	K	M	PA	PA	PA	PA	PA						
2,200 pF	222	J	K	M	PA	PA	PA	PA	PA						
Capacitance	Capacitance Code	Rated Voltage (VDC)			10	16	25	50	100	10	16	25	50	100	200
		Voltage Code			8	4	3	5	1	8	4	3	5	1	2
		Case Size / Series			C0508					C0612					

KEMET reserves the right to substitute product with an improved temperature characteristic, tighter capacitance tolerance and/or higher voltage capability within the same form factor (configuration and dimensions).

These products are protected under US Patents 7,172,985 and 7,670,981, other patents pending, and any foreign counterparts.

Table 2 – Chip Thickness/Packaging Quantities

Thickness Code	Case Size	Thickness ± Range (mm)	Paper Quantity		Plastic Quantity	
			7" Reel	13" Reel	7" Reel	13" Reel
PA	0508	0.80 ± 0.10	0	0	4,000	10,000
MA	0612	0.80 ± 0.10	0	0	4,000	10,000

Package quantity based on finished chip thickness specifications.

Table 3 – Chip Capacitor Array Land Pattern Design Recommendations per IPC-7351

EIA SIZE CODE	METRIC SIZE CODE	Density Level A: Maximum (Most) Land Protrusion (mm)						Density Level B: Median (Nominal) Land Protrusion (mm)						Density Level C: Minimum (Least) Land Protrusion (mm)					
		C	Y	X	P	V1	V2	C	Y	X	P	V1	V2	C	Y	X	P	V1	V2
0508/CA052	1220	1.60	1.00	0.55	1.00	3.50	3.30	1.50	0.90	0.50	1.00	2.90	2.80	1.40	0.75	0.45	1.00	2.40	2.50
0612/CA064	1632	1.80	1.10	0.50	0.80	3.90	4.40	1.80	0.95	0.50	0.80	3.30	3.90	1.70	0.85	0.40	0.80	2.80	3.60

Density Level A: For low-density product applications. Provides a wider process window for reflow solder processes.

Density Level B: For products with a moderate level of component density. Provides a robust solder attachment condition for reflow solder processes.

Density Level C: For high component density product applications. Before adapting the minimum land pattern variations the user should perform qualification testing based on the conditions outlined in IPC Standard 7351 (IPC-7351).

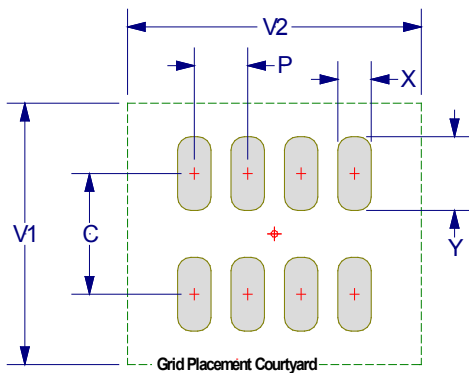

Soldering Process

Recommended Soldering Technique:

- Solder reflow only

Recommended Soldering Profile:

- KEMET recommends following the guidelines outlined in IPC/JEDEC J-STD-020

Table 4 – Performance & Reliability: Test Methods and Conditions

Stress	Reference	Test or Inspection Method
Terminal Strength	JIS-C-6429	Appendix 1, Note: Force of 1.8 kg for 60 seconds.
Board Flex	JIS-C-6429	Appendix 2, Note: Standard termination system – 2.0 mm (minimum) for all except 3 mm for COG. Flexible termination system – 3.0 mm (minimum).
Solderability	J-STD-002	Magnification 50 X. Conditions:
		a) Method B, 4 hours @ 155°C, dry heat @ 235°C
		b) Method B @ 215°C category 3
		c) Method D, category 3 @ 260°C
Temperature Cycling	JESD22 Method JA-104	1,000 Cycles (-55°C to +125°C). Measurement at 24 hours +/- 2 hours after test conclusion.
Biased Humidity	MIL-STD-202 Method 103	Load Humidity: 1,000 hours 85°C/85% RH and rated voltage. Add 100 K ohm resistor. Measurement at 24 hours +/- 2 hours after test conclusion.
		Low Volt Humidity: 1,000 hours 85°C/85% RH and 1.5 V. Add 100 K ohm resistor. Measurement at 24 hours +/- 2 hours after test conclusion.
Moisture Resistance	MIL-STD-202 Method 106	t = 24 hours/cycle. Steps 7a and 7b not required. Unpowered. Measurement at 24 hours +/- 2 hours after test conclusion.
Thermal Shock	MIL-STD-202 Method 107	-55°C/+125°C. Note: Number of cycles required – 300, maximum transfer time – 20 seconds, dwell time – 15 minutes. Air – Air.
High Temperature Life	MIL-STD-202 Method 108 /EIA-198	1,000 hours at 125°C (85°C for X5R, Z5U and Y5V) with 2 X rated voltage applied.
Storage Life	MIL-STD-202 Method 108	150°C, 0 VDC for 1,000 hours.
Vibration	MIL-STD-202 Method 204	5 g's for 20 min., 12 cycles each of 3 orientations. Note: Use 8" X 5" PCB 0.031" thick 7 secure points on one long side and 2 secure points at corners of opposite sides. Parts mounted within 2" from any secure point. Test from 10 – 2,000 Hz
Mechanical Shock	MIL-STD-202 Method 213	Figure 1 of Method 213, Condition F.
Resistance to Solvents	MIL-STD-202 Method 215	Add aqueous wash chemical, OKEM Clean or equivalent.

Storage & Handling

Ceramic chip capacitors should be stored in normal working environments. While the chips themselves are quite robust in other environments, solderability will be degraded by exposure to high temperatures, high humidity, corrosive atmospheres, and long term storage. In addition, packaging materials will be degraded by high temperature– reels may soften or warp and tape peel force may increase. KEMET recommends that maximum storage temperature not exceed 40°C and maximum storage humidity not exceed 70% relative humidity. Temperature fluctuations should be minimized to avoid condensation on the parts and atmospheres should be free of chlorine and sulfur bearing compounds. For optimized solderability chip stock should be used promptly, preferably within 1.5 years of receipt.

Construction – Standard Termination

Reference	Item		Material
A	Termination System	Finish	100% Matte Sn
B		Barrier Layer	Ni
C		Base Metal	Cu
D	Inner Electrode		Ni
E	Dielectric Material		CaZrO ₃

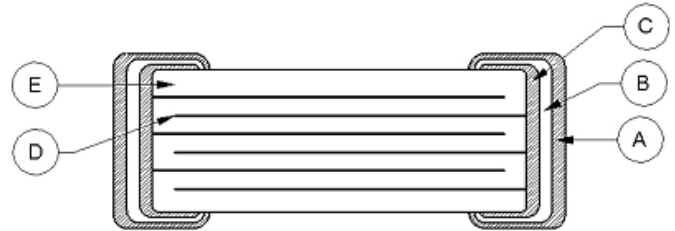

Note: Image is exaggerated in order to clearly identify all components of construction.

Construction – Flexible Termination

Reference	Item		Material
A	Termination System	Finish	100% Matte Sn
B		Barrier Layer	Ni
C		Epoxy Layer	Ag
D		Base Metal	Cu
E	Inner Electrode		Ni
F	Dielectric Material		CaZrO ₃

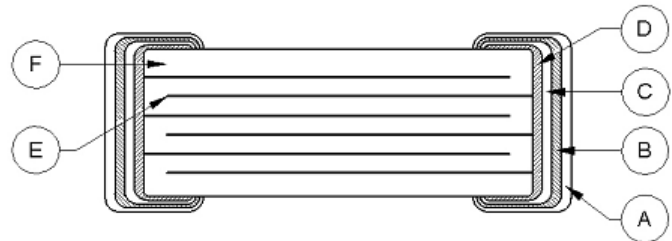

Note: Image is exaggerated in order to clearly identify all components of construction.

Capacitor Marking (Optional):

Laser marking option is not available on:

- COG, Ultra Stable X8R and Y5V dielectric devices
- EIA 0402 case size devices
- EIA 0603 case size devices with Flexible Termination option.
- KPS Commercial and Automotive grade stacked devices.

These capacitors are supplied unmarked only.

Capacitor Array, X7R Dielectric, 10 – 200 VDC (Commercial & Automotive Grade)

Overview

KEMET's Ceramic Chip Capacitor Array in X7R dielectric is an advanced passive technology where multiple capacitor elements are integrated into one common monolithic structure. Array technology promotes reduced placement costs and increased throughput. This is achieved by alternatively placing one device rather than two or four discrete devices. Use of capacitor arrays also saves board space which translates into increased board density and more functions per board. Arrays consume only a portion of the space required for standard chips resulting in savings in inventory and pick/place machine positions.

KEMET's X7R dielectric features a 125°C maximum operating temperature and is considered "temperature stable." The

Electronics Industries Alliance (EIA) characterizes X7R dielectric as a Class II material. Components of this classification are fixed, ceramic dielectric capacitors suited for bypass and decoupling applications or for frequency discriminating circuits where Q and stability of capacitance characteristics are not critical. X7R exhibits a predictable change in capacitance with respect to time and voltage and boasts a minimal change in capacitance with reference to ambient temperature. Capacitance change is limited to $\pm 15\%$ from -55°C to +125°C.

KEMET automotive grade array capacitors meet the demanding Automotive Electronics Council's AEC-Q200 qualification requirements.

Benefits

- -55°C to +125°C operating temperature range
- Saves both circuit board and inventory space
- Reduces placement costs and increases throughput
- RoHS Compliant
- EIA 0508 (2-element) and 0612 (4-element) case sizes
- DC voltage ratings of 10 V, 16 V, 25 V, 50 V, 100 V, and 200 V

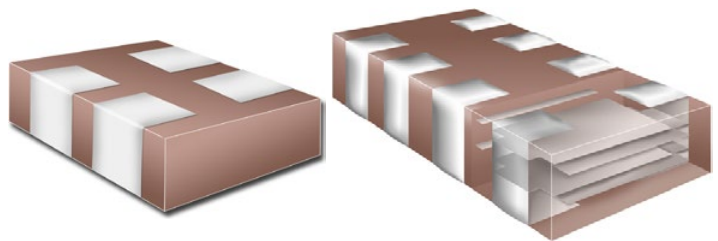

Ordering Information

CA	06	4	C	104	K	4	R	A	C	TU
Ceramic Array	Case Size (L" x W") ¹	Number of Capacitors	Specification/ Series	Capacitance Code (pF)	Capacitance Tolerance	Voltage	Dielectric	Failure Rate/ Design	Termination Finish ²	Packaging/Grade (C-Spec) ³
	05 = 0508 06 = 0612	2 = 2 4 = 4	C = Standard X = Flexible Termination	2 Significant Digits + Number of Zeros	J = $\pm 5\%$ K = $\pm 10\%$ M = $\pm 20\%$	8 = 10 V 4 = 16 V 3 = 25 V 5 = 50 V 1 = 100 V 2 = 200 V	R = X7R	A = N/A	C = 100% Matte Sn L = SnPb (5% minimum)	Blank = Bulk TU = 7" Reel Unmarked TM = 7" Reel Marked AUTO = Automotive Grade

¹ All previous reference to metric case dimension "1632" has been replaced with an inch standard reference of "0612". Please reference all new designs using the "0612" nomenclature. "CA064" replaces "C1632" in the ordering code.

² Additional termination finish options may be available. Contact KEMET for details.

^{2,3} SnPb termination finish option is not available on automotive grade product.

³ Additional reeling or packaging options may be available. Contact KEMET for details.

Dimensions – Millimeters (Inches)

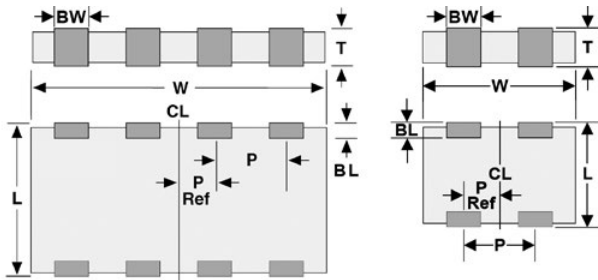

EIA Size Code	Metric Size Code	L Length	W Width	BW Bandwidth	BL Bandlength	T Thickness	P Pitch	P Reference
0508	1220	1.30 (0.051) ±0.15 (0.006)	2.10 (0.083) ±0.15 (0.006)	0.53 (0.021) ±0.08 (0.003)	0.30 (0.012) ±0.20 (0.008)	See Table 2 for Thickness	1.00 (0.039) ±0.10 (0.004)	0.50 (0.020) ±0.10 (0.004)
0612	1632	1.60 (0.063) ±0.20 (0.008)	3.20 (0.126) ±0.20 (0.008)	0.40 (0.016) ±0.20 (0.008)	0.30 (0.012) ±0.20 (0.008)		0.80 (0.031) ±0.10 (0.004)	0.40 (0.016) ±0.05 (0.002)

Benefits cont'd

- Capacitance offerings ranging from 330 pF – 0.22 µF
- Available capacitance tolerances of ±5%, ±10%, and ±20%
- Non-polar device, minimizing installation concerns
- 100% pure matte tin-plated termination finish allowing for excellent solderability
- SnPb termination finish option available upon request (5% minimum)
- Flexible termination option available upon request
- Commercial and Automotive (AEC-Q200) grades available

Applications

Typical applications include those that can benefit from board area savings, cost savings and overall volumetric reduction such as telecommunications, computers, handheld devices and automotive.

Qualification/Certification

Commercial Grade products are subject to internal qualification. Details regarding test methods and conditions are referenced in Table 4, Performance & Reliability.

Automotive Grade products meet or exceed the requirements outlined by the Automotive Electronics Council. Details regarding test methods and conditions are referenced in document AEC-Q200, Stress Test Qualification for Passive Components. For additional information regarding the Automotive Electronics Council and AEC-Q200, please visit their website at www.aecouncil.com.

Environmental Compliance

Pb-Free and RoHS Compliant (excluding SnPb termination finish option).



RoHS Compliant

Electrical Parameters/Characteristics

Item	Parameters/Characteristics
Operating Temperature Range	-55°C to +125°C
Capacitance Change with Reference to +25°C and 0 VDC Applied (TCC)	±15%
Aging Rate (Maximum % Capacitance Loss/Decade Hour)	3.0%
Dielectric Withstanding Voltage (DWV)	250% of rated voltage (5 ±1 seconds and charge/discharge not exceeding 50 mA)
Dissipation Factor (DF) Maximum Limit @ 25°C	5%(10 V), 3.5%(16 V and 25 V) and 2.5%(50 V to 200 V)
Insulation Resistance (IR) Limit @ 25°C	1,000 megohm microfarads or 100 GΩ (Rated voltage applied for 120 ±5 seconds @ 25°C)

Regarding aging rate: Capacitance measurements (including tolerance) are indexed to a referee time of 1,000 hours.

To obtain IR limit, divide MΩ-μF value by the capacitance and compare to GΩ limit. Select the lower of the two limits.

Capacitance and dissipation factor (DF) measured under the following conditions:

1 kHz ±50 Hz and 1.0 ±0.2 Vrms if capacitance ≤ 10 μF

120 Hz ±10 Hz and 0.5 ±0.1 Vrms if capacitance > 10 μF

Note: When measuring capacitance it is important to ensure the set voltage level is held constant. The HP4284 and Agilent E4980 have a feature known as Automatic Level Control (ALC). The ALC feature should be switched to "ON."

Post Environmental Limits

High Temperature Life, Biased Humidity, Moisture Resistance					
Dielectric	Rated DC Voltage	Capacitance Value	Dissipation Factor (Maximum %)	Capacitance Shift	Insulation Resistance
X7R	> 25	All	3.0	±20%	10% of Initial Limit
	16/25		5.0		
	< 16		7.5		

Table 1 – Capacitance Range/Selection Waterfall (0508 – 0612 Case Sizes)

Capacitance	Capacitance Code	Case Size / Series			C0508 (CA052C 2-Cap Case Size)					C0612 (CA064C 4-Cap Case Size)					
		Voltage Code			8	4	3	5	1	8	4	3	5	1	2
		Rated Voltage (VDC)			10	16	25	50	100	10	16	25	50	100	200
		Capacitance Tolerance			Product Availability and Chip Thickness Codes See Table 2 for Chip Thickness Dimensions										
330 pF	331	J	K	M	PA	PA	PA	PA	PA	MA	MA	MA	MA	MA	MA
390 pF	391	J	K	M	PA	PA	PA	PA	PA	MA	MA	MA	MA	MA	MA
470 pF	471	J	K	M	PA	PA	PA	PA	PA	MA	MA	MA	MA	MA	MA
560 pF	561	J	K	M	PA	PA	PA	PA	PA	MA	MA	MA	MA	MA	MA
680 pF	681	J	K	M	PA	PA	PA	PA	PA	MA	MA	MA	MA	MA	MA
820 pF	821	J	K	M	PA	PA	PA	PA	PA	MA	MA	MA	MA	MA	
1,000 pF	102	J	K	M	PA	PA	PA	PA	PA	MA	MA	MA	MA	MA	
1,200 pF	122	J	K	M	PA	PA	PA	PA	PA	MA	MA	MA	MA	MA	
1,500 pF	152	J	K	M	PA	PA	PA	PA	PA	MA	MA	MA	MA	MA	
1,800 pF	182	J	K	M	PA	PA	PA	PA	PA	MA	MA	MA	MA	MA	
2,200 pF	222	J	K	M	PA	PA	PA	PA	PA	MA	MA	MA	MA	MA	
2,700 pF	272	J	K	M	PA	PA	PA	PA	PA	MA	MA	MA	MA	MA	
3,300 pF	332	J	K	M	PA	PA	PA	PA	PA	MA	MA	MA	MA	MA	
3,900 pF	392	J	K	M	PA	PA	PA	PA	PA	MA	MA	MA	MA	MA	
4,700 pF	472	J	K	M	PA	PA	PA	PA	PA	MA	MA	MA	MA	MA	
5,600 pF	562	J	K	M	PA	PA	PA	PA		MA	MA	MA	MA		
6,800 pF	682	J	K	M	PA	PA	PA	PA		MA	MA	MA	MA		
8,200 pF	822	J	K	M	PA	PA	PA	PA		MA	MA	MA	MA		
10,000 pF	103	J	K	M	PA	PA	PA	PA		MA	MA	MA	MA		
12,000 pF	123	J	K	M	PA	PA	PA	PA		MA	MA	MA	MA		
15,000 pF	153	J	K	M	PA	PA	PA	PA		MA	MA	MA	MA		
18,000 pF	183	J	K	M	PA	PA	PA	PA		MA	MA	MA	MA		
22,000 pF	223	J	K	M	PA	PA	PA	PA		MA	MA	MA	MA		
27,000 pF	273	J	K	M	PA	PA	PA	PA		MA	MA	MA	MA		
33,000 pF	333	J	K	M	PA	PA	PA	PA		MA	MA	MA			
39,000 pF	393	J	K	M	PA	PA	PA	PA		MA	MA	MA			
47,000 pF	473	J	K	M	PA	PA	PA	PA		MA	MA	MA			
56,000 pF	563	J	K	M	PA	PA	PA	PA		MA	MA	MA			
68,000 pF	683	J	K	M	PA	PA	PA	PA		MA	MA				
82,000 pF	823	J	K	M	PA	PA	PA	PA		MA	MA				
0.10 uF	104	J	K	M	PA	PA	PA	PA		MA	MA				
0.15 uF	154	J	K	M	PA										
0.22 uF	224	J	K	M	PA										
Capacitance	Capacitance Code	Rated Voltage (VDC)			10	16	25	50	100	10	16	25	50	100	200
		Voltage Code			8	4	3	5	1	8	4	3	5	1	2
		Case Size / Series			C0508					C0612					

Table 2 – Chip Thickness / Packaging Quantities

Thickness Code	Case Size	Thickness ± Range (mm)	Paper Quantity		Plastic Quantity	
			7" Reel	13" Reel	7" Reel	13" Reel
PA	0508	0.80 ± 0.10	0	0	4,000	10,000
MA	0612	0.80 ± 0.10	0	0	4,000	10,000

Package quantity based on finished chip thickness specifications.

Table 3 – Chip Capacitor Array Land Pattern Design Recommendations per IPC–7351

EIA SIZE CODE	METRIC SIZE CODE	Density Level A: Maximum (Most) Land Protrusion (mm)						Density Level B: Median (Nominal) Land Protrusion (mm)						Density Level C: Minimum (Least) Land Protrusion (mm)					
		C	Y	X	P	V1	V2	C	Y	X	P	V1	V2	C	Y	X	P	V1	V2
0508/CA052	1220	1.60	1.00	0.55	1.00	3.50	3.30	1.50	0.90	0.50	1.00	2.90	2.80	1.40	0.75	0.45	1.00	2.40	2.50
0612/CA064	1632	1.80	1.10	0.50	0.80	3.90	4.40	1.80	0.95	0.50	0.80	3.30	3.90	1.70	0.85	0.40	0.80	2.80	3.60

Density Level A: For low-density product applications. Provides a wider process window for reflow solder processes.

Density Level B: For products with a moderate level of component density. Provides a robust solder attachment condition for reflow solder processes.

Density Level C: For high component density product applications. Before adapting the minimum land pattern variations the user should perform qualification testing based on the conditions outlined in IPC Standard 7351 (IPC–7351).

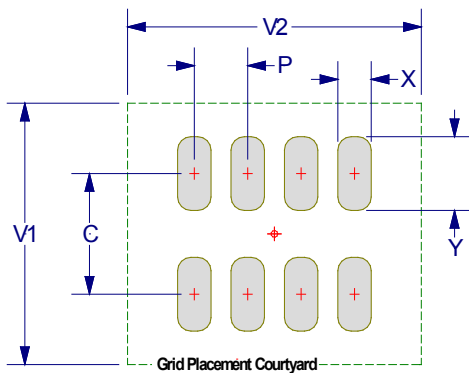

Soldering Process

Recommended Soldering Technique:

- Solder reflow only

Recommended Soldering Profile:

- KEMET recommends following the guidelines outlined in IPC/JEDEC J–STD–020

Table 4 – Performance & Reliability: Test Methods and Conditions

Stress	Reference	Test or Inspection Method
Terminal Strength	JIS-C-6429	Appendix 1, Note: Force of 1.8 kg for 60 seconds.
Board Flex	JIS-C-6429	Appendix 2, Note: Standard termination system – 2.0 mm (minimum) for all except 3 mm for COG. Flexible termination system – 3.0 mm (minimum).
Solderability	J-STD-002	Magnification 50 X. Conditions:
		a) Method B, 4 hours @ 155°C, dry heat @ 235°C
		b) Method B @ 215°C category 3
		c) Method D, category 3 @ 260°C
Temperature Cycling	JESD22 Method JA-104	1,000 Cycles (-55°C to +125°C). Measurement at 24 hours +/- 2 hours after test conclusion.
Biased Humidity	MIL-STD-202 Method 103	Load Humidity: 1,000 hours 85°C/85% RH and rated voltage. Add 100 K ohm resistor. Measurement at 24 hours +/- 2 hours after test conclusion.
		Low Volt Humidity: 1,000 hours 85°C/85% RH and 1.5 V. Add 100 K ohm resistor. Measurement at 24 hours +/- 2 hours after test conclusion.
Moisture Resistance	MIL-STD-202 Method 106	t = 24 hours/cycle. Steps 7a and 7b not required. Unpowered. Measurement at 24 hours +/- 2 hours after test conclusion.
Thermal Shock	MIL-STD-202 Method 107	-55°C/+125°C. Note: Number of cycles required – 300, maximum transfer time – 20 seconds, dwell time – 15 minutes. Air – Air.
High Temperature Life	MIL-STD-202 Method 108 /EIA-198	1,000 hours at 125°C (85°C for X5R, Z5U and Y5V) with 2 X rated voltage applied.
Storage Life	MIL-STD-202 Method 108	150°C, 0 VDC for 1,000 hours.
Vibration	MIL-STD-202 Method 204	5 g's for 20 min., 12 cycles each of 3 orientations. Note: Use 8" X 5" PCB 0.031" thick 7 secure points on one long side and 2 secure points at corners of opposite sides. Parts mounted within 2" from any secure point. Test from 10 – 2,000 Hz
Mechanical Shock	MIL-STD-202 Method 213	Figure 1 of Method 213, Condition F.
Resistance to Solvents	MIL-STD-202 Method 215	Add aqueous wash chemical, OKEM Clean or equivalent.

Storage & Handling

Ceramic chip capacitors should be stored in normal working environments. While the chips themselves are quite robust in other environments, solderability will be degraded by exposure to high temperatures, high humidity, corrosive atmospheres, and long term storage. In addition, packaging materials will be degraded by high temperature– reels may soften or warp and tape peel force may increase. KEMET recommends that maximum storage temperature not exceed 40°C and maximum storage humidity not exceed 70% relative humidity. Temperature fluctuations should be minimized to avoid condensation on the parts and atmospheres should be free of chlorine and sulfur bearing compounds. For optimized solderability chip stock should be used promptly, preferably within 1.5 years of receipt.

Construction – Standard Termination

Reference	Item		Material
A	Termination System	Finish	100% Matte Sn
B		Barrier Layer	Ni
C		Base Metal	Cu
D	Inner Electrode		Ni
E	Dielectric Material		BaTiO ₃

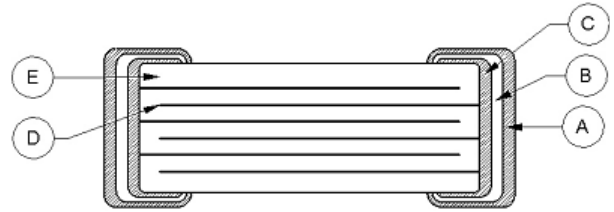

Note: Image is exaggerated in order to clearly identify all components of construction.

Construction – Flexible Termination

Reference	Item		Material
A	Termination System	Finish	100% Matte Sn
B		Barrier Layer	Ni
C		Epoxy Layer	Ag
D		Base Metal	Cu
E	Inner Electrode		Ni
F	Dielectric Material		BaTiO ₃

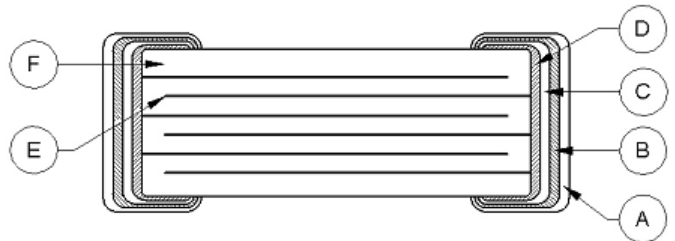

Note: Image is exaggerated in order to clearly identify all components of construction.

Commercial Off-the-Shelf (COTS) for Higher Reliability Applications, C0G Dielectric, 10 – 200 VDC

Overview

KEMET's COTS program is an extension of KEMET knowledge of high reliability test regimes and requirements. KEMET regularly supplies "up-screened" products by working with customer drawings and imposing specified design and test requirements. The COTS program offers the same high quality and high reliability components as up-screened products, but at a lower cost to the customer. This is accomplished by eliminating the need for customer-specific drawings to achieve the reliability level required for customer applications. A series of tests and inspections have been selected to provide the accelerated conditioning and 100% screening necessary to eliminate infant mortal failures from the population.

KEMET's C0G dielectric features a 125°C maximum operating temperature and is considered "stable." The Electronics Components, Assemblies & Materials Association (EIA) characterizes C0G dielectric as a Class I material. Components of this classification are temperature compensating and are suited for resonant circuit applications or those where Q and stability of capacitance characteristics are required. C0G exhibits no change in capacitance with respect to time and voltage and boasts a negligible change in capacitance with reference to ambient

temperature. Capacitance change is limited to ± 30 ppm/°C from -55°C to +125°C.

All COTS testing includes voltage conditioning and post-electrical testing as per MIL-PRF-55681. For enhanced reliability, KEMET also provides the following test level options and conformance certifications:

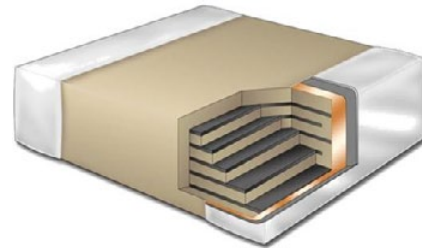
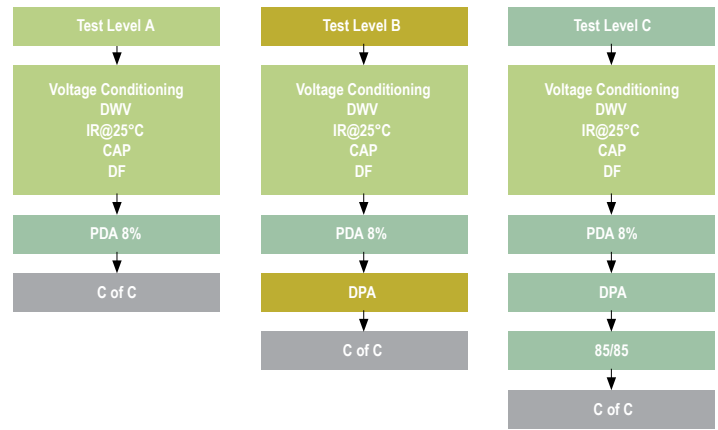

Ordering Information

C	1206	T	104	K	5	G	A	C	TU
Ceramic	Case Size (L" x W")	Specification/ Series	Capacitance Code (pF)	Capacitance Tolerance ¹	Voltage	Dielectric	Failure Rate/Design	Termination Finish ²	Packaging/Grade (C-Spec) ³
	0402 0603 0805 1206 1210 1812 2220	T = COTS	2 Significant Digits + Number of Zeros Use 9 for 1.0 – 9.9 pF Use 8 for 0.5 – .99 pF ex. 2.2 pF = 229 ex. 0.5 pF = 508	B = ± 0.10 pF C = ± 0.25 pF D = ± 0.5 pF F = $\pm 1\%$ G = $\pm 2\%$ J = $\pm 5\%$ K = $\pm 10\%$ M = $\pm 20\%$	8 = 10 V 4 = 16 V 3 = 25 V 6 = 35 V 5 = 50 V 1 = 100 V 2 = 200 V	G = C0G	A = Testing per MIL-PRF-55681 PDA 8% B = Testing per MIL-PRF-55681 PDA 8%, DPA per EIA-469 C = Testing per MIL-PRF-55681 PDA 8%, DPA per EIA-469, Humidity per MIL-STD-202, Method 103, Condition A	C = 100% Matte Sn L = SnPb (5% minimum)	Blank = Bulk TU = 7" Reel Unmarked TM = 7" Reel Marked

¹ Additional capacitance tolerance offerings may be available. Contact KEMET for details.

² Additional termination finish options may be available. Contact KEMET for details.

³ Additional reeling or packaging options may be available. Contact KEMET for details.

Dimensions – Millimeters (Inches)

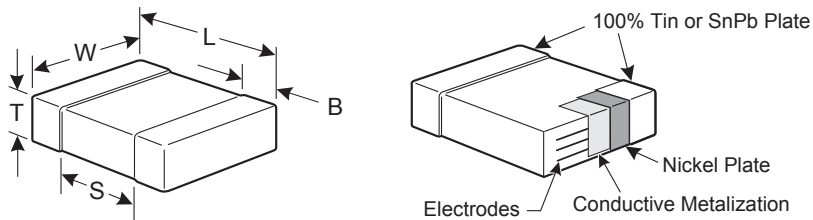

EIA Size Code	Metric Size Code	L Length	W Width	T Thickness	B Bandwidth	S Separation Minimum	Mounting Technique
0402	1005	1.00 (.040) ± 0.05 (.002)	0.50 (.020) ± 0.05 (.002)	See Table 2 for Thickness	0.30 (.012) ± 0.10 (.004)	0.30 (.012)	Solder Reflow Only
0603	1608	1.60 (.063) ± 0.15 (.006)	0.80 (.032) ± 0.15 (.006)		0.35 (.014) ± 0.15 (.006)	0.70 (.028)	Solder Wave or Solder Reflow
0805	2012	2.00 (.079) ± 0.20 (.008)	1.25 (.049) ± 0.20 (.008)		0.50 (0.02) ± 0.25 (.010)	0.75 (.030)	
1206	3216	3.20 (.126) ± 0.20 (.008)	1.60 (.063) ± 0.20 (.008)		0.50 (0.02) ± 0.25 (.010)	N/A	Solder Reflow Only
1210	3225	3.20 (.126) ± 0.20 (.008)	2.50 (.098) ± 0.20 (.008)		0.50 (0.02) ± 0.25 (.010)		
1812	4532	4.50 (.177) ± 0.30 (.012)	3.20 (.126) ± 0.30 (.012)		0.60 (.024) ± 0.35 (.014)		
2220	5650	5.70 (.224) ± 0.40 (.016)	5.00 (.197) ± 0.40 (.016)		0.60 (.024) ± 0.35 (.014)		

Benefits

- -55°C to +125°C operating temperature range
- Voltage conditioning and post-electrical testing per MIL-PRF-55681, Paragraph 4.8.3.1, Standard Voltage Conditioning
- Destructive Physical Analysis (DPA) per EIA-469
- Humidity, steady state, low voltage (85/85) per MIL-STD-202, Method 103, Condition A
- Certificate of compliance
- RoHS Compliant (excluding SnPb end metallization option)
- EIA 0402, 0603, 0805, 1206, 1210, 1812, and 2220 case sizes
- DC voltage ratings of 10 V, 16 V, 25 V, 50 V, 100 V, and 200 V
- Capacitance offerings ranging from 0.5 pF up to 0.47 µF
- Available capacitance tolerances of ±0.10 pF, ±0.25 pF, ±0.5 pF, ±1%, ±2%, ±5%, ±10%, and ±20%
- No piezoelectric noise
- Extremely low ESR and ESL
- High thermal stability
- High ripple current capability
- Preferred capacitance solution at line frequencies and into the MHz range
- No capacitance change with respect to applied rated DC voltage
- Negligible capacitance change with respect to temperature
- No capacitance decay with time
- Non-polar device, minimizing installation concerns
- SnPb end metallization option available upon request (5% minimum)

Applications

Typical applications include military, space quality and high reliability electronics.

Qualification/Certification

Commercial Grade products are subject to internal qualification. Details regarding test methods and conditions are referenced in Table 4, Performance & Reliability.

Environmental Compliance

Pb-Free and RoHS Compliant.



RoHS Compliant

Electrical Parameters/Characteristics

Item	Parameters/Characteristics
Operating Temperature Range	-55°C to +125°C
Capacitance Change with Reference to +25°C and 0 VDC Applied (TCC)	±30 ppm/°C
Aging Rate (Maximum % Capacitance Loss/Decade Hour)	0%
Dielectric Withstanding Voltage (DWV)	250% of rated voltage (5 ±1 seconds and charge/discharge not exceeding 50 mA)
Dissipation Factor (DF) Maximum Limit @ 25°C	0.1%
Insulation Resistance (IR) Limit @ 25°C	1,000 megohm microfarads or 100 GΩ (Rated voltage applied for 120 ±5 seconds @ 25°C)

To obtain IR limit, divide MΩ-μF value by the capacitance and compare to GΩ limit. Select the lower of the two limits.

Capacitance and dissipation factor (DF) measured under the following conditions:

1 MHz ±100 kHz and 1.0 Vrms ±0.2 V if capacitance ≤ 1,000 pF

1 kHz ±50 Hz and 1.0 Vrms ±0.2 V if capacitance > 1,000 pF

Note: When measuring capacitance it is important to ensure the set voltage level is held constant. The HP4284 and Agilent E4980 have a feature known as Automatic Level Control (ALC). The ALC feature should be switched to "ON."

Post Environmental Limits

High Temperature Life, Biased Humidity, Moisture Resistance					
Dielectric	Rated DC Voltage	Capacitance Value	Dissipation Factor (Maximum %)	Capacitance Shift	Insulation Resistance
COG	All	All	0.5	0.3% or ±0.25 pF	10% of Initial Limit

Table 1A – Capacitance Range/Selection Waterfall (0402 – 0805 Case Sizes)

Capacitance	Cap Code	Case Size / Series						C0402C						C0603C						C0805C											
		Voltage Code						8	4	3	5	1	2	8	4	3	5	1	2	8	4	3	5	1	2						
		Rated Voltage (VDC)						10	16	25	50	100	200	10	16	25	50	100	200	10	16	25	50	100	200						
		Capacitance Tolerance						Product Availability and Chip Thickness Codes See Table 2 for Chip Thickness Dimensions																							
0.50 & 0.75 pF	508 & 758	B	C	D				BB	BB	BB	BB					CB	CB	CB	CB	CB	CB					DC	DC	DC	DC	DC	DC
1.0 - 9.1 pF*	109 - 919*	B	C	D				BB	BB	BB	BB					CB	CB	CB	CB	CB	CB					DC	DC	DC	DC	DC	DC
10 - 91 pF*	100 - 910*				F	G	J	K	M							CB	CB	CB	CB	CB	CB					DC	DC	DC	DC	DC	DC
100 pF	101				F	G	J	K	M	BB	BB	BB	BB	BB	BB	CB	CB	CB	CB	CB	CB					DC	DC	DC	DC	DC	DC
110 - 270 pF*	111 - 271*				F	G	J	K	M	BB	BB	BB	BB	BB	BB	CB	CB	CB	CB	CB	CB					DC	DC	DC	DC	DC	DC
300 pF	301				F	G	J	K	M	BB	BB	BB	BB	BB	BB	CB	CB	CB	CB	CB	CB					DC	DC	DC	DC	DC	DC
330 pF	331				F	G	J	K	M	BB	BB	BB	BB	BB	BB	CB	CB	CB	CB	CB	CB					DC	DC	DC	DC	DC	DC
360 pF	361				F	G	J	K	M	BB	BB	BB	BB	BB	BB	CB	CB	CB	CB	CB	CB					DC	DC	DC	DC	DC	DC
390 pF	391				F	G	J	K	M	BB	BB	BB	BB	BB	BB	CB	CB	CB	CB	CB	CB					DC	DC	DC	DC	DC	DC
430 pF	431				F	G	J	K	M	BB	BB	BB	BB	BB	BB	CB	CB	CB	CB	CB	CB					DC	DC	DC	DC	DC	DC
470 pF	471				F	G	J	K	M	BB	BB	BB	BB	BB	BB	CB	CB	CB	CB	CB	CB					DC	DC	DC	DC	DC	DC
510 - 820 pF*	511 - 821*				F	G	J	K	M	BB	BB	BB	BB	BB	BB	CB	CB	CB	CB	CB	CB					DC	DC	DC	DC	DC	DC
910 pF	911				F	G	J	K	M	BB	BB	BB	BB	BB	BB	CB	CB	CB	CB	CB	CB					DC	DC	DC	DC	DC	DC
1,000 pF	102				F	G	J	K	M	BB	BB	BB	BB	BB	BB	CB	CB	CB	CB	CB	CB					DC	DC	DC	DC	DC	DC
1,100 pF	112				F	G	J	K	M	BB	BB	BB	BB	BB	BB	CB	CB	CB	CB	CB	CH					DC	DC	DC	DC	DC	DC
1,200 pF	122				F	G	J	K	M	BB	BB	BB	BB			CB	CB	CB	CB	CB	CH					DC	DC	DC	DC	DC	DC
1,300 pF	132				F	G	J	K	M	BB	BB	BB	BB			CB	CB	CB	CB	CB	CH					DD	DD	DD	DD	DD	DC
1,500 pF	152				F	G	J	K	M	BB	BB	BB	BB	BB		CB	CB	CB	CB	CB	CH					DD	DD	DD	DD	DD	DC
1,600 pF	162				F	G	J	K	M	BB	BB	BB	BB			CB	CB	CB	CB	CB	CH					DD	DD	DD	DD	DD	DC
1,800 pF	182				F	G	J	K	M	BB	BB	BB				CB	CB	CB	CB	CB	CH					DD	DD	DD	DD	DD	DC
2,000 pF	202				F	G	J	K	M	BB	BB	BB				CB	CB	CB	CB	CB	CH					DC	DC	DC	DC	DC	DC
2,200 pF	222				F	G	J	K	M	BB	BB	BB				CB	CB	CB	CB	CB	CH					DC	DC	DC	DC	DC	DC
2,400 pF	242				F	G	J	K	M							CB	CB	CB	CB	CB						DC	DC	DC	DC	DC	DC
2,700 pF	272				F	G	J	K	M							CB	CB	CB	CB	CB						DC	DC	DC	DC	DC	DC
3,000 pF	302				F	G	J	K	M							CB	CB	CB	CB	CB						DD	DD	DD	DD	DC	DC
3,300 pF	332				F	G	J	K	M							CB	CB	CB	CB	CB						DD	DD	DD	DD	DC	DC
3,600 pF	362				F	G	J	K	M							CB	CB	CB	CB	CB						DD	DD	DD	DD	DC	DC
3,900 pF	392				F	G	J	K	M							CB	CB	CB	CB	CB						DE	DE	DE	DE	DC	DD
4,300 pF	432				F	G	J	K	M							CB	CB	CB	CB	CB						DE	DE	DE	DE	DC	DD
4,700 pF	472				F	G	J	K	M							CB	CB	CB	CB	CB						DE	DE	DE	DE	DC	DD
5,100 pF	512				F	G	J	K	M							CB	CB	CB	CB							DE	DE	DE	DE	DC	DD
5,600 pF	562				F	G	J	K	M							CB	CB	CB	CB							DC	DC	DC	DC	DC	DD
6,200 pF	622				F	G	J	K	M							CB	CB	CB	CB							DC	DC	DC	DC	DC	DG
6,800 pF	682				F	G	J	K	M							CB	CB	CB	CB							DC	DC	DC	DC	DC	DG
7,500 pF	752				F	G	J	K	M							CB	CB	CB								DC	DC	DC	DC	DC	DG
8,200 pF	822				F	G	J	K	M							CB	CB	CB								DC	DC	DC	DC	DC	DG
9,100 pF	912				F	G	J	K	M							CB	CB	CB								DC	DC	DC	DC	DC	
10,000 pF	103				F	G	J	K	M							CB	CB	CB								DC	DC	DC	DC	DD	
12,000 pF	123				F	G	J	K	M							CB	CB	CB								DC	DC	DC	DC	DE	
15,000 pF	153				F	G	J	K	M							CB	CB	CB								DC	DC	DC	DD	DG	
18,000 pF	183				F	G	J	K	M																	DC	DC	DC	DD		
22,000 pF	223				F	G	J	K	M																	DD	DD	DD	DF		
27,000 pF	273				F	G	J	K	M																	DF	DF	DF			
33,000 pF	333				F	G	J	K	M																	DG	DG	DG			
39,000 pF	393				F	G	J	K	M																	DG	DG	DG			
47,000 pF	473				F	G	J	K	M																	DG	DG	DG			
Capacitance	Cap Code	Rated Voltage (VDC)						10	16	25	50	100	200	10	16	25	50	100	200	10	16	25	50	100	200						
		Voltage Code						8	4	3	5	1	2	8	4	3	5	1	2	8	4	3	5	1	2						
		Case Size / Series						C0402C						C0603C						C0805C											

*Capacitance range Includes E24 decade values only. (i.e., 10, 11, 12, 13, 15, 16, 18, 20, 22, 24, 27, 30, 33, 36, 39, 43, 47, 51, 56, 62, 68, 75, 82 and 91)
 KEMET reserves the right to substitute product with an improved temperature characteristic, tighter capacitance tolerance and/or higher voltage capability within the same form factor (configuration and dimensions).
 These products are protected under US Patents 7,172,985 & 7,670,981, other patents pending, and any foreign counterparts.

Table 1B – Capacitance Range/Selection Waterfall (1206 – 2220 Case Sizes)

Capacitance	Cap Code	Case Size / Series			C1206C						C1210C						C1812C			C2220C							
		Voltage Code			8	4	3	5	1	2	8	4	3	5	1	2	5	1	2	3	1	2					
		Rated Voltage (VDC)			10	16	25	50	100	200	10	16	25	50	100	200	50	100	200	50	100	200					
		Capacitance Tolerance			Product Availability and Chip Thickness Codes See Table 2 for Chip Thickness Dimensions																						
1.0 - 9.1 pF*	109 - 919*	B	C	D	F	G	J	K	M	EB	EB	EB	EB	EB	EB	FB	FB	FB	FB	FB	FB						
10 - 91 pF*	100 - 910*				F	G	J	K	M	EB	EB	EB	EB	EB	EB	FB	FB	FB	FB	FB	FB						
100 - 430 pF*	101 - 431*				F	G	J	K	M	EB	EB	EB	EB	EB	EB	FB	FB	FB	FB	FB	FB						
470 - 910 pF*	471 - 911*				F	G	J	K	M	EB	EB	EB	EB	EB	EB	FB	FB	FB	FB	FB	FB	GB	GB	GB			
1,000 pF	102				F	G	J	K	M	EB	EB	EB	EB	EB	EE	FB	FB	FB	FB	FB	FB	GB	GB	GB			
1,100 pF	112				F	G	J	K	M	EB	EB	EB	EB	EB	EB	FB	FB	FB	FB	FB	FB	GB	GB	GB			
1,200 pF	122				F	G	J	K	M	EB	EB	EB	EB	EB	EB	FB	FB	FB	FB	FB	FB	GB	GB	GB			
1,300 pF	132				F	G	J	K	M	EB	EB	EB	EB	EC	EB	FB	FB	FB	FB	FB	FB	GB	GB	GB			
1,500 pF	152				F	G	J	K	M	EB	EB	EB	EB	ED	EC	FB	FB	FB	FB	FB	FE	GB	GB	GB			
1,600 pF	162				F	G	J	K	M	EB	EB	EB	EB	ED	ED	FB	FB	FB	FB	FB	FE	GB	GB	GB			
1,800 pF	182				F	G	J	K	M	EB	EB	EB	EB	ED	ED	FB	FB	FB	FB	FB	FE	GB	GB	GB			
2,000 pF	202				F	G	J	K	M	EB	EB	EB	EB	ED	ED	FB	FB	FB	FB	FB	FC	GB	GB	GB			
2,200 pF	222				F	G	J	K	M	EB	EB	EB	EB	EE	ED	FB	FB	FB	FB	FC	FG	GB	GB	GB			
2,400 pF	242				F	G	J	K	M	EB	EB	EB	EB	EC	EC	FB	FB	FB	FB	FC	FC						
2,700 pF	272				F	G	J	K	M	EB	EB	EB	EB	EC	EC	FB	FB	FB	FB	FC	FC	GB	GB	GB			
3,000 pF	302				F	G	J	K	M	EC	EC	EC	EC	EC	EB	FB	FB	FB	FB	FC	FF						
3,300 pF	332				F	G	J	K	M	EC	EC	EC	EC	EE	EB	FB	FB	FB	FB	FF	FF	GB	GB	GB			
3,600 pF	362				F	G	J	K	M	EC	EC	EC	EC	EE	EB	FB	FB	FB	FB	FF	FF						
3,900 pF	392				F	G	J	K	M	EC	EC	EC	EC	EF	EB	FB	FB	FB	FB	FF	FF	GB	GB	GB			
4,300 pF	432				F	G	J	K	M	EC	EC	EC	EC	EC	EB	FB	FB	FB	FB	FF	FF						
4,700 pF	472				F	G	J	K	M	EC	EC	EC	EC	EC	EB	FF	FF	FF	FF	FG	FG	GB	GB	GD			
5,100 pF	512				F	G	J	K	M	ED	ED	ED	ED	ED	EB	FB	FB	FB	FB	FG	FG						
5,600 pF	562				F	G	J	K	M	ED	ED	ED	ED	ED	EB	FB	FB	FB	FB	FG	FG	GB	GB	GH			
6,200 pF	622				F	G	J	K	M	EB	EB	EB	EB	EB	EB	FB	FB	FB	FB	FG	FB						
6,800 pF	682				F	G	J	K	M	EB	EB	EB	EB	EB	EB	FB	FB	FB	FB	FG	FB	GB	GB	GJ	JE	JE	JB
7,500 pF	752				F	G	J	K	M	EB	EB	EB	EB	EB	EB	FC	FC	FC	FC	FC	FB						
8,200 pF	822				F	G	J	K	M	EC	EC	EC	EC	EB	EC	FC	FC	FC	FC	FC	FB	GB	GH	GB	JE	JE	JB
9,100 pF	912				F	G	J	K	M	EC	EC	EC	EC	EB	EC	FE	FE	FE	FE	FE	FB						
10,000 pF	103				F	G	J	K	M	ED	ED	ED	ED	EB	EC	FF	FF	FF	FF	FF	FB	GB	GH	GB	JE	JE	JB
12,000 pF	123				F	G	J	K	M	EB	EB	EB	EB	EB	ED	FG	FG	FG	FG	FB	FB	GB	GG	GB	JE	JE	JB
15,000 pF	153				F	G	J	K	M	EB	EB	EB	EB	EB	EF	FG	FG	FG	FG	FB	FC	GB	GB	GB	JE	JE	JB
18,000 pF	183				F	G	J	K	M	EB	EB	EB	EB	EB	EH	FB	FB	FB	FB	FB	FC	GB	GB	GB	JE	JE	JB
22,000 pF	223				F	G	J	K	M	EB	EB	EB	EB	EC	EH	FB	FB	FB	FB	FB	FF	GB	GB	GB	JE	JB	JB
27,000 pF	273				F	G	J	K	M	EB	EB	EB	EB	EE		FB	FB	FB	FB	FB	FG	GB	GB	GB	JE	JB	JB
33,000 pF	333				F	G	J	K	M	EB	EB	EB	EB	EE		FB	FB	FB	FB	FB	FH	GB	GB	GB	JB	JB	JB
39,000 pF	393				F	G	J	K	M	EC	EC	EC	EE	EH		FB	FB	FB	FB	FE	FH	GB	GB	GB	JB	JB	JB
47,000 pF	473				F	G	J	K	M	EC	EC	EC	EE	EH		FB	FB	FB	FB	FE	FJ	GB	GB	GD	JB	JB	JB
56,000 pF	563				F	G	J	K	M	ED	ED	ED	EF			FB	FB	FB	FB	FF		GB	GB	GD	JB	JB	JB
68,000 pF	683				F	G	J	K	M	EF	EF	EF	EH			FB	FB	FB	FC	FG		GB	GB	GK	JB	JB	JB
82,000 pF	823				F	G	J	K	M	EH	EH	EH				FC	FC	FC	FF	FH		GB	GB	GM	JB	JB	JB
0.10 μF	104				F	G	J	K	M	EH	EH	EH				FE	FE	FE	FG	FM		GB	GD	GM	JB	JB	JD
0.12 μF	124				F	G	J	K	M							FG	FG	FG	FH			GB	GH		JB	JB	JD
0.15 μF	154				F	G	J	K	M							FH	FH	FH	FM			GD	GN		JB	JB	JG
0.18 μF	184				F	G	J	K	M							FJ	FJ	FJ				GH			JB	JD	JG
0.22 μF	224				F	G	J	K	M							FK	FK	FK				GK			JB	JD	JL
0.27 μF	274				F	G	J	K	M																JB	JF	
0.33 μF	334				F	G	J	K	M																JD	JG	
0.39 μF	394				F	G	J	K	M																JG		
0.47 μF	474				F	G	J	K	M																JG		
Capacitance	Cap Code	Rated Voltage (VDC)			10	16	25	50	100	200	10	16	25	50	100	200	50	100	200	50	100	200					
		Voltage Code			8	4	3	5	1	2	8	4	3	5	1	2	5	1	2	3	1	2					
		Case Size / Series			C1206C						C1210C						C1812C			C2220C							

*Capacitance range Includes E24 decade values only. (i.e., 10, 11, 12, 13, 15, 16, 18, 20, 22, 24, 27, 30, 33, 36, 39, 43, 47, 51, 56, 62, 68, 75, 82 and 91)
 KEMET reserves the right to substitute product with an improved temperature characteristic, tighter capacitance tolerance and/or higher voltage capability within the same form factor (configuration and dimensions).
 These products are protected under US Patents 7,172,985 & 7,670,981, other patents pending, and any foreign counterparts.

Table 2 – Chip Thickness/Packaging Quantities

Thickness Code	Case Size	Thickness ± Range (mm)	Paper Quantity		Plastic Quantity	
			7" Reel	13" Reel	7" Reel	13" Reel
BB	402	0.50 ± 0.05	10000	50000	0	0
BD	402	0.55 ± 0.05	10000	50000	0	0
CB	603	0.80 ± 0.07	4000	10000	0	0
CF	603	0.80 ± 0.07	4000	15000	0	0
CH	603	0.85 ± 0.07	4000	10000	0	0
DE	0805	0.70 ± 0.20	4,000	10,000	0	0
DC	0805	0.78 ± 0.10	4,000	10,000	0	0
DD	0805	0.90 ± 0.10	4,000	10,000	0	0
DF	0805	1.10 ± 0.10	0	0	2,500	10,000
DG	0805	1.25 ± 0.15	0	0	2,500	10,000
EB	1206	0.78 ± 0.10	4,000	10,000	4,000	10,000
EC	1206	0.90 ± 0.10	0	0	4,000	10,000
ED	1206	1.00 ± 0.10	0	0	2,500	10,000
EE	1206	1.10 ± 0.10	0	0	2,500	10,000
EF	1206	1.20 ± 0.15	0	0	2,500	10,000
EH	1206	1.60 ± 0.20	0	0	2,000	8,000
FB	1210	0.78 ± 0.10	0	0	4,000	10,000
FC	1210	0.90 ± 0.10	0	0	4,000	10,000
FE	1210	1.00 ± 0.10	0	0	2,500	10,000
FF	1210	1.10 ± 0.10	0	0	2,500	10,000
FG	1210	1.25 ± 0.15	0	0	2,500	10,000
FH	1210	1.55 ± 0.15	0	0	2,000	8,000
FM	1210	1.70 ± 0.20	0	0	2,000	8,000
FJ	1210	1.85 ± 0.20	0	0	2,000	8,000
FK	1210	2.10 ± 0.20	0	0	2,000	8,000
GB	1812	1.00 ± 0.10	0	0	1,000	4,000
GD	1812	1.25 ± 0.15	0	0	1,000	4,000
GH	1812	1.40 ± 0.15	0	0	1,000	4,000
GG	1812	1.55 ± 0.10	0	0	1,000	4,000
GK	1812	1.60 ± 0.20	0	0	1,000	4,000
GJ	1812	1.70 ± 0.15	0	0	1,000	4,000
GN	1812	1.70 ± 0.20	0	0	1,000	4,000
GM	1812	2.00 ± 0.20	0	0	500	2,000
JB	2220	1.00 ± 0.15	0	0	1,000	4,000
JD	2220	1.30 ± 0.15	0	0	1,000	4,000
JE	2220	1.40 ± 0.15	0	0	1,000	4,000
JF	2220	1.50 ± 0.15	0	0	1,000	4,000
JG	2220	1.70 ± 0.15	0	0	1,000	4,000
JL	2220	2.00 ± 0.20	0	0	500	2,000
Thickness Code	Case Size	Thickness ± Range (mm)	7" Reel	13" Reel	7" Reel	13" Reel
			Paper Quantity		Plastic Quantity	

Package quantity based on finished chip thickness specifications.

Table 3 – Chip Capacitor Land Pattern Design Recommendations per IPC–7351

EIA Size Code	Metric Size Code	Density Level A: Maximum (Most) Land Protrusion (mm)					Density Level B: Median (Nominal) Land Protrusion (mm)					Density Level C: Minimum (Least) Land Protrusion (mm)				
		C	Y	X	V1	V2	C	Y	X	V1	V2	C	Y	X	V1	V2
0402	1005	0.50	0.72	0.72	2.20	1.20	0.45	0.62	0.62	1.90	1.00	0.40	0.52	0.52	1.60	0.80
0603	1608	0.90	1.15	1.10	4.00	2.10	0.80	0.95	1.00	3.10	1.50	0.60	0.75	0.90	2.40	1.20
0805	2012	1.00	1.35	1.55	4.40	2.60	0.90	1.15	1.45	3.50	2.00	0.75	0.95	1.35	2.80	1.70
1206	3216	1.60	1.35	1.90	5.60	2.90	1.50	1.15	1.80	4.70	2.30	1.40	0.95	1.70	4.00	2.00
1210	3225	1.60	1.35	2.80	5.65	3.80	1.50	1.15	2.70	4.70	3.20	1.40	0.95	2.60	4.00	2.90
1210 ¹	3225	1.50	1.60	2.90	5.60	3.90	1.40	1.40	2.80	4.70	3.30	1.30	1.20	2.70	4.00	3.00
1812	4532	2.15	1.60	3.60	6.90	4.60	2.05	1.40	3.50	6.00	4.00	1.95	1.20	3.40	5.30	3.70
2220	5650	2.75	1.70	5.50	8.20	6.50	2.65	1.50	5.40	7.30	5.90	2.55	1.30	5.30	6.60	5.60

¹ Only for capacitance values $\geq 22 \mu\text{F}$

Density Level A: For low-density product applications. Recommended for wave solder applications and provides a wider process window for reflow solder processes. KEMET only recommends wave soldering of EIA 0603, 0805, and 1206 case sizes.

Density Level B: For products with a moderate level of component density. Provides a robust solder attachment condition for reflow solder processes.

Density Level C: For high component density product applications. Before adapting the minimum land pattern variations the user should perform qualification testing based on the conditions outlined in IPC Standard 7351 (IPC–7351).

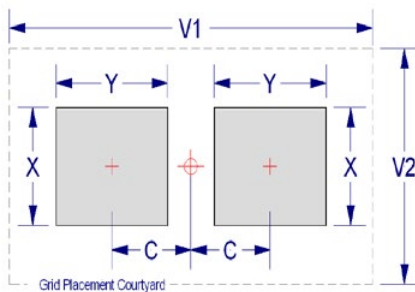

Soldering Process

Recommended Soldering Technique:

- Solder wave or solder reflow for EIA case sizes 0603, 0805, and 1206
- All other EIA case sizes are limited to solder reflow only

Recommended Soldering Profile:

- KEMET recommends following the guidelines outlined in IPC/JEDEC J–STD–020

Table 4 – Performance & Reliability: Test Methods and Conditions

Stress	Reference	Test or Inspection Method
Terminal Strength	JIS-C-6429	Appendix 1, Note: Force of 1.8 kg for 60 seconds.
Board Flex	JIS-C-6429	Appendix 2, Note: Standard termination system – 2.0 mm (minimum) for all except 3 mm for COG. Flexible termination system – 3.0 mm (minimum).
Solderability	J-STD-002	Magnification 50 X. Conditions:
		a) Method B, 4 hours @ 155°C, dry heat @ 235°C
		b) Method B @ 215°C category 3
		c) Method D, category 3 @ 260°C
Temperature Cycling	JESD22 Method JA-104	1,000 Cycles (-55°C to +125°C). Measurement at 24 hours +/- 2 hours after test conclusion.
Biased Humidity	MIL-STD-202 Method 103	Load Humidity: 1,000 hours 85°C/85% RH and rated voltage. Add 100 K ohm resistor. Measurement at 24 hours +/- 2 hours after test conclusion.
		Low Volt Humidity: 1,000 hours 85°C/85% RH and 1.5 V. Add 100 K ohm resistor. Measurement at 24 hours +/- 2 hours after test conclusion.
Moisture Resistance	MIL-STD-202 Method 106	t = 24 hours/cycle. Steps 7a and 7b not required. Unpowered. Measurement at 24 hours +/- 2 hours after test conclusion.
Thermal Shock	MIL-STD-202 Method 107	-55°C/+125°C. Note: Number of cycles required – 300, maximum transfer time – 20 seconds, dwell time – 15 minutes. Air – Air.
High Temperature Life	MIL-STD-202 Method 108 /EIA-198	1,000 hours at 125°C (85°C for X5R, Z5U and Y5V) with 2 X rated voltage applied.
Storage Life	MIL-STD-202 Method 108	150°C, 0 VDC for 1,000 hours.
Vibration	MIL-STD-202 Method 204	5 g's for 20 min., 12 cycles each of 3 orientations. Note: Use 8" X 5" PCB 0.031" thick 7 secure points on one long side and 2 secure points at corners of opposite sides. Parts mounted within 2" from any secure point. Test from 10 – 2,000 Hz
Mechanical Shock	MIL-STD-202 Method 213	Figure 1 of Method 213, Condition F.
Resistance to Solvents	MIL-STD-202 Method 215	Add aqueous wash chemical, OKEM Clean or equivalent.

Storage and Handling

Ceramic chip capacitors should be stored in normal working environments. While the chips themselves are quite robust in other environments, solderability will be degraded by exposure to high temperatures, high humidity, corrosive atmospheres, and long term storage. In addition, packaging materials will be degraded by high temperature– reels may soften or warp and tape peel force may increase. KEMET recommends that maximum storage temperature not exceed 40°C and maximum storage humidity not exceed 70% relative humidity. Temperature fluctuations should be minimized to avoid condensation on the parts and atmospheres should be free of chlorine and sulfur bearing compounds. For optimized solderability chip stock should be used promptly, preferably within 1.5 years of receipt.

Construction

Reference	Item		Material
A	Termination System	Finish	100% Matte Sn
B		Barrier Layer	Ni
C		Base Metal	Cu
D	Inner Electrode		Ni
E	Dielectric Material		CaZrO ₃

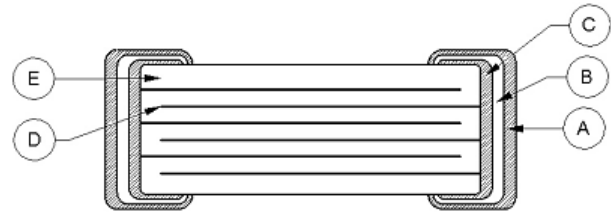

Note: Image is exaggerated in order to clearly identify all components of construction.

Capacitor Marking (Optional):

Laser marking option is not available on:

- COG, Ultra Stable X8R and Y5V dielectric devices
- EIA 0402 case size devices
- EIA 0603 case size devices with Flexible Termination option.
- KPS Commercial and Automotive grade stacked devices.

These capacitors are supplied unmarked only.

Commercial Off-the-Shelf (COTS) for Higher Reliability Applications, X7R Dielectric, 6.3 – 250 VDC

Overview

KEMET’s COTS program is an extension of KEMET knowledge of high reliability test regimes and requirements. KEMET regularly supplies “up-screened” products by working with customer drawings and imposing specified design and test requirements. The COTS program offers the same high quality and high reliability components as up-screened products, but at a lower cost to the customer. This is accomplished by eliminating the need for customer-specific drawings to achieve the reliability level required for customer applications. A series of tests and inspections have been selected to provide the accelerated conditioning and 100% screening necessary to eliminate infant mortal failures from the population.

KEMET’s X7R dielectric features a 125°C maximum operating temperature and is considered “temperature stable.” The Electronics Components, Assemblies & Materials Association (EIA) characterizes X7R dielectric as a Class II material. Components of this classification are fixed, ceramic dielectric capacitors suited for bypass and decoupling applications or for frequency discriminating circuits where Q and stability of capacitance characteristics are not critical. X7R exhibits a predictable change in capacitance with respect to time and voltage and boasts a minimal change in capacitance with reference to ambient temperature. Capacitance change is limited to ±15% from -55°C to +125°C.

All COTS testing includes voltage conditioning and post-electrical testing as per MIL-PRF-55681. For enhanced reliability, KEMET also provides the following test level options and conformance certifications:

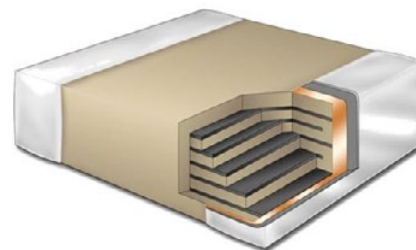
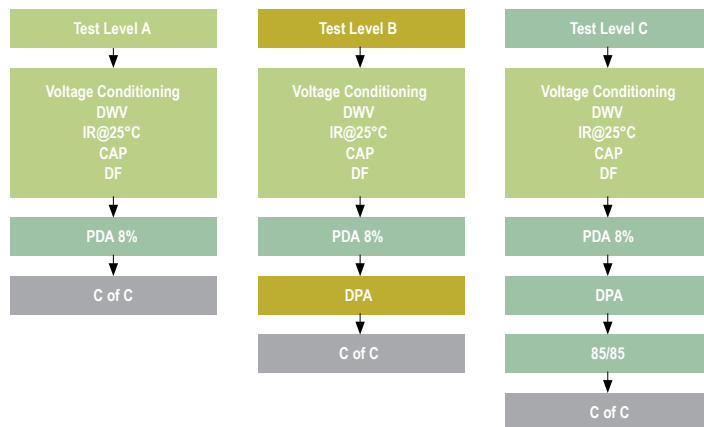

Ordering Information

C	1210	T	104	K	5	R	A	C	TU
Ceramic	Case Size (L" x W")	Specification/ Series	Capacitance Code (pF)	Capacitance Tolerance	Voltage	Dielectric	Failure Rate/Design	Termination Finish ¹	Packaging/Grade (C-Spec) ²
	0402 0603 0805 1206 1210 1812 2220	T = COTS	2 Significant Digits + Number of Zeros	J = ±5% K = ±10% M = ±20%	9 = 6.3 V 8 = 10 V 4 = 16 V 3 = 25 V 5 = 50 V 1 = 100 V 2 = 200 V A = 250 V	R = X7R	A = Testing per MIL-PRF-55681 PDA 8% B= Testing per MIL-PRF-55681 PDA 8%, DPA per EIA-469 C = Testing per MIL-PRF-55681 PDA 8%, DPA per EIA-469, Humidity per MIL-STD-202, Method 103, Condition A	C = 100% Matte Sn L = SnPb (5% minimum)	Blank = Bulk TU = 7" Reel Unmarked TM = 7" Reel Marked

¹ Additional termination finish options may be available. Contact KEMET for details.

² Additional reeling or packaging options may be available. Contact KEMET for details.

Dimensions – Millimeters (Inches)

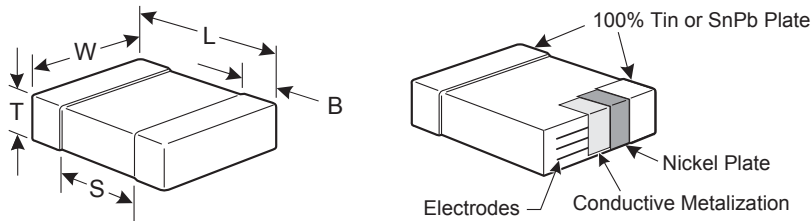

EIA Size Code	Metric Size Code	L Length	W Width	T Thickness	B Bandwidth	S Separation Minimum	Mounting Technique
0402	1005	1.00 (.040) ± 0.05 (.002)	0.50 (.020) ± 0.05 (.002)	See Table 2 for Thickness	0.30 (.012) ± 0.10 (.004)	0.30 (.012)	Solder Reflow Only
0603	1608	1.60 (.063) ± 0.15 (.006)	0.80 (.032) ± 0.15 (.006)		0.35 (.014) ± 0.15 (.006)	0.70 (.028)	Solder Wave or Solder Reflow
0805	2012	2.00 (.079) ± 0.20 (.008)	1.25 (.049) ± 0.20 (.008)		0.50 (0.02) ± 0.25 (.010)	0.75 (.030)	
1206	3216	3.20 (.126) ± 0.20 (.008)	1.60 (.063) ± 0.20 (.008)		0.50 (0.02) ± 0.25 (.010)	N/A	Solder Reflow Only
1210 ¹	3225	3.20 (.126) ± 0.20 (.008)	2.50 (.098) ± 0.20 (.008)		0.50 (0.02) ± 0.25 (.010)		
1812	4532	4.50 (.177) ± 0.30 (.012)	3.20 (.126) ± 0.30 (.012)		0.60 (.024) ± 0.35 (.014)		
2220	5650	5.70 (.224) ± 0.40 (.016)	5.00 (.197) ± 0.40 (.016)		0.60 (.024) ± 0.35 (.014)		

¹ For capacitance values ≥ 12 μF add 0.02 (0.001) to the width tolerance dimension

Benefits

- -55°C to +125°C operating temperature range
- Pb-Free and RoHS Compliant
- Voltage conditioning and post-electrical testing per MIL-PRF-55681
- Destructive Physical Analysis (DPA) per EIA-469
- Biased humidity testing (85/85) per MIL-STD-202
- Certificate of Compliance
- Temperature stable dielectric
- EIA 0402, 0603, 0805, 1206, 1210, 1812, and 2220 case sizes
- DC voltage ratings of 6.3 V, 10 V, 16 V, 25 V, 50 V, 100 V, 200 V, and 250 V
- Capacitance offerings ranging from 10 pF to 22 μF
- Available capacitance tolerances of ±5%, ±10%, and ±20%
- Non-polar device, minimizing installation concerns
- 100% pure matte tin-plated termination finish allowing for excellent solderability
- SnPb termination finish option available upon request (5% minimum)

Applications

Typical applications include military, space quality and high reliability electronics.

Qualification/Certification

Commercial Grade products are subject to internal qualification. Details regarding test methods and conditions are referenced in Table 4, Performance & Reliability.

Environmental Compliance

Pb-Free and RoHS Compliant (excluding SnPb termination finish option).



RoHS Compliant

Electrical Parameters/Characteristics

Item	Parameters/Characteristics
Operating Temperature Range	-55°C to +125°C
Capacitance Change with Reference to +25°C and 0 VDC Applied (TCC)	±15%
Aging Rate (Maximum % Capacitance Loss/Decade Hour)	3.0%
Dielectric Withstanding Voltage (DWV)	250% of rated voltage (5 ±1 seconds and charge/discharge not exceeding 50 mA)
Dissipation Factor (DF) Maximum Limit @ 25°C	5% (6.3 and 10 V), 3.5% (16 and 25 V) and 2.5% (50 V to 250 V)
Insulation Resistance (IR) Limit @ 25°C	See Insulation Resistance Limit Table (Rated voltage applied for 120 ±5 seconds @ 25°C)

Regarding aging rate: Capacitance measurements (including tolerance) are indexed to a referee time of 1,000 hours.

To obtain IR limit, divide $M\Omega \cdot \mu F$ value by the capacitance and compare to $G\Omega$ limit. Select the lower of the two limits.

Capacitance and dissipation factor (DF) measured under the following conditions:

1 kHz ±50 Hz and 1.0 ±0.2 Vrms if capacitance ≤ 10 μF

120 Hz ±10 Hz and 0.5 ±0.1 Vrms if capacitance > 10 μF

Note: When measuring capacitance it is important to ensure the set voltage level is held constant. The HP4284 and Agilent E4980 have a feature known as Automatic Level Control (ALC). The ALC feature should be switched to "ON."

Post Environmental Limits

High Temperature Life, Biased Humidity, Moisture Resistance					
Dielectric	Rated DC Voltage	Capacitance Value	Dissipation Factor (Maximum %)	Capacitance Shift	Insulation Resistance
X7R	> 25	All	3.0	±20%	10% of Initial Limit
	16/25		5.0		
	< 16		7.5		

Insulation Resistance Limit Table

EIA Case Size	1,000 Megohm Microfarads or 100 GΩ	500 Megohm Microfarads or 10 GΩ
0201	N/A	ALL
0402	< 0.012 μF	≥ 0.012 μF
0603	< 0.047 μF	≥ 0.047 μF
0805	< 0.047 μF	≥ 0.047 μF
1206	< 0.22 μF	≥ 0.22 μF
1210	< 0.39 μF	≥ 0.39 μF
1808	ALL	N/A
1812	< 2.2 μF	≥ 2.2 μF
1825	ALL	N/A
2220	< 10 μF	≥ 10 μF
2225	ALL	N/A

Table 1A – Capacitance Range/Selection Waterfall (0402 – 1206 Case Sizes)

Capacitance	Cap Code	Case Size / Series			C0402C					C0603C						C0805C							C1206C											
		Voltage Code			9	8	4	3	5	9	8	4	3	5	1	2	9	8	4	3	5	1	2	A	9	8	4	3	5	1	2	A		
		Rated Voltage (VDC)			6.3	10	16	25	50	6.3	10	16	25	50	100	200	6.3	10	16	25	50	100	200	250	6.3	10	16	25	50	100	200	250		
		Capacitance Tolerance			Product Availability and Chip Thickness Codes See Table 2 for Chip Thickness Dimensions																													
10 - 91 pF*	100 - 910*	J	K	M	BB	BB	BB	BB	BB	CB	CB	CB	CB	CB	CB	DC	DC	DC	DC	DC	DC	DC	DC	DC	DC	DC	DC	DC	DC	DC	DC	DC	DC	
100 - 150 pF**	101 - 151**	J	K	M	BB	BB	BB	BB	BB	CB	CB	CB	CB	CB	CB	DC	DC	DC	DC	DC	DC	DC	DC	DC	DC	DC	DC	DC	DC	DC	DC	DC	DC	DC
180 - 820 pF**	181 - 820**	J	K	M	BB	BB	BB	BB	BB	CB	CB	CB	CB	CB	CB	DC	DC	DC	DC	DC	DC	DC	DC	DC	DC	DC	DC	DC	DC	DC	DC	DC	DC	DC
1,000 pF	102	J	K	M	BB	BB	BB	BB	BB	CB	CB	CB	CB	CB	CB	DC	DC	DC	DC	DC	DC	DC	DC	DC	DC	DC	DC	DC	DC	DC	DC	DC	DC	DC
1,200 pF	122	J	K	M	BB	BB	BB	BB	BB	CB	CB	CB	CB	CB	CB	DC	DC	DC	DC	DC	DC	DC	DC	DC	DC	DC	DC	DC	DC	DC	DC	DC	DC	DC
1,500 pF	152	J	K	M	BB	BB	BB	BB	BB	CB	CB	CB	CB	CB	CB	DC	DC	DC	DC	DC	DC	DC	DC	DC	DC	DC	DC	DC	DC	DC	DC	DC	DC	DC
1,800 pF	182	J	K	M	BB	BB	BB	BB	BB	CB	CB	CB	CB	CB	CB	DC	DC	DC	DC	DC	DC	DC	DC	DC	DC	DC	DC	DC	DC	DC	DC	DC	DC	DC
2,200 pF	222	J	K	M	BB	BB	BB	BB	BB	CB	CB	CB	CB	CB	CB	DC	DC	DC	DC	DC	DC	DC	DC	DC	DC	DC	DC	DC	DC	DC	DC	DC	DC	DC
2,700 pF	272	J	K	M	BB	BB	BB	BB	BB	CB	CB	CB	CB	CB	CF	DC	DC	DC	DC	DC	DC	DC	DC	DC	DC	DC	DC	DC	DC	DC	DC	DC	DC	DC
3,300 pF	332	J	K	M	BB	BB	BB	BB	BB	CB	CB	CB	CB	CB	CB	DC	DC	DC	DC	DC	DC	DC	DC	DC	DC	DC	DC	DC	DC	DC	DC	DC	DC	DC
3,900 pF	392	J	K	M	BB	BB	BB	BB	BB	CB	CB	CB	CB	CB	CB	DC	DC	DC	DC	DC	DC	DC	DC	DC	DC	DC	DC	DC	DC	DC	DC	DC	DC	DC
4,700 pF	472	J	K	M	BB	BB	BB	BB	BB	CB	CB	CB	CB	CB	CB	DC	DC	DC	DC	DC	DC	DC	DC	DC	DC	DC	DC	DC	DC	DC	DC	DC	DC	DC
5,600 pF	562	J	K	M	BB	BB	BB	BB	BB	CB	CB	CB	CB	CB	CB	DC	DC	DC	DC	DC	DC	DC	DC	DC	DC	DC	DC	DC	DC	DC	DC	DC	DC	DC
6,800 pF	682	J	K	M	BB	BB	BB	BB	BB	CB	CB	CB	CB	CB	CB	DC	DC	DC	DC	DC	DC	DC	DC	DC	DC	DC	DC	DC	DC	DC	DC	DC	DC	DC
8,200 pF	822	J	K	M	BB	BB	BB	BB	BB	CB	CB	CB	CB	CB	CB	DC	DC	DC	DC	DC	DC	DC	DC	DC	DC	DC	DC	DC	DC	DC	DC	DC	DC	DC
10,000 pF	103	J	K	M	BB	BB	BB	BB	BB	CB	CB	CB	CB	CF	CF	DC	DC	DC	DC	DC	DC	DC	DC	DC	DC	DC	DC	DC	DC	DC	DC	DC	DC	DC
12,000 pF	123	J	K	M	BB	BB	BB	BB	BB	CB	CB	CB	CB	CB	CB	DC	DC	DC	DC	DC	DC	DC	DC	DC	DC	DC	DC	DC	DC	DC	DC	DC	DC	DC
15,000 pF	153	J	K	M	BB	BB	BB	BB	BB	CB	CB	CB	CB	CB	CB	DC	DC	DC	DC	DC	DC	DC	DC	DC	DC	DC	DC	DC	DC	DC	DC	DC	DC	DC
18,000 pF	183	J	K	M	BB	BB	BB	BB	BB	CB	CB	CB	CB	CB	CB	DC	DC	DC	DC	DC	DC	DC	DC	DC	DC	DC	DC	DC	DC	DC	DC	DC	DC	DC
22,000 pF	223	J	K	M	BB	BB	BB	BB	BB	CB	CB	CB	CB	CF	CF	DC	DC	DC	DC	DC	DC	DC	DC	DC	DC	DC	DC	DC	DC	DC	DC	DC	DC	DC
27,000 pF	273	J	K	M	BB	BB	BB	BB	BB	CB	CB	CB	CB	CB	CB	DC	DC	DC	DC	DC	DC	DC	DC	DC	DC	DC	DC	DC	DC	DC	DC	DC	DC	DC
33,000 pF	333	J	K	M	BB	BB	BB	BB	BB	CB	CB	CB	CF	CB	CB	DC	DC	DC	DC	DC	DC	DC	DC	DC	DC	DC	DC	DC	DC	DC	DC	DC	DC	DC
39,000 pF	393	J	K	M	BB	BB	BB	BB	BB	CB	CB	CB	CB	CB	CB	DC	DC	DC	DC	DC	DC	DC	DC	DC	DC	DC	DC	DC	DC	DC	DC	DC	DC	DC
47,000 pF	473	J	K	M	BB	BB	BB	BB	BB	CB	CB	CB	CB	CF	CB	DC	DC	DC	DC	DC	DC	DC	DC	DC	DC	DC	DC	DC	DC	DC	DC	DC	DC	DC
56,000 pF	563	J	K	M	BB	BB	BB	BB	BB	CB	CB	CB	CB	CB	CB	DD	DD	DD	DD	DD	DD	DE	DE	DE	DE	DE	DE	DE	DE	DE	DE	DE	DE	DE
68,000 pF	683	J	K	M	BB	BB	BB	BB	BB	CB	CB	CB	CF	CB	CB	DD	DD	DD	DD	DD	DD	DE	DE	DE	DE	DE	DE	DE	DE	DE	DE	DE	DE	DE
82,000 pF	823	J	K	M	BB	BB	BB	BB	BB	CB	CB	CB	CB	CB	CB	DD	DD	DD	DD	DD	DD	DE	DE	DE	DE	DE	DE	DE	DE	DE	DE	DE	DE	DE
0.10 μF	104	J	K	M	BB	BB	BB	BB	BB	CB	CB	CF	CF	CF	CF	DC	DC	DC	DC	DC	DC	DC	DC	DC	DC	DC	DC	DC	DC	DC	DC	DC	DC	
0.12 μF	124	J	K	M	BB	BB	BB	BB	BB	CB	CB	CB	CB	CB	CB	DC	DC	DC	DC	DC	DC	DC	DC	DC	DC	DC	DC	DC	DC	DC	DC	DC	DC	
0.15 μF	154	J	K	M	BB	BB	BB	BB	BB	CB	CB	CB	CB	CB	CB	DC	DC	DC	DC	DC	DC	DC	DC	DC	DC	DC	DC	DC	DC	DC	DC	DC	DC	DC
0.18 μF	184	J	K	M	BB	BB	BB	BB	BB	CB	CB	CB	CB	CB	CB	DC	DC	DC	DC	DC	DC	DC	DC	DC	DC	DC	DC	DC	DC	DC	DC	DC	DC	DC
0.22 μF	224	J	K	M	BB	BB	BB	BB	BB	CB	CB	CB	CB	CB	CB	DC	DC	DC	DC	DC	DC	DC	DC	DC	DC	DC	DC	DC	DC	DC	DC	DC	DC	DC
0.27 μF	274	J	K	M	BB	BB	BB	BB	BB	CB	CB	CB	CB	CB	CB	DD	DD	DD	DD	DD	DD	DD	DD	DD	DD	DD	DD	DD	DD	DD	DD	DD	DD	DD
0.33 μF	334	J	K	M	BB	BB	BB	BB	BB	CB	CB	CB	CB	CB	CB	DD	DD	DD	DD	DD	DD	DD	DD	DD	DD	DD	DD	DD	DD	DD	DD	DD	DD	DD
0.39 μF	394	J	K	M	BB	BB	BB	BB	BB	CB	CB	CB	CB	CB	CB	DG	DG	DG	DG	DG	DG	DE	DE	DE	DE	DE	DE	DE	DE	DE	DE	DE	DE	DE
0.47 μF	474	J	K	M	BB	BB	BB	BB	BB	CB	CB	CB	CB	CB	CB	DD	DD	DD	DD	DD	DD	DE	DE	DE	DE	DE	DE	DE	DE	DE	DE	DE	DE	DE
0.56 μF	564	J	K	M	BB	BB	BB	BB	BB	CB	CB	CB	CB	CB	CB	DD	DD	DD	DG	DH	DH	DH	DH	DH	DH	DH	DH	DH	DH	DH	DH	DH	DH	
0.68 μF	684	J	K	M	BB	BB	BB	BB	BB	CB	CB	CB	CB	CB	CB	DD	DD	DD	DG	DH	DH	DH	DH	DH	DH	DH	DH	DH	DH	DH	DH	DH	DH	DH
0.82 μF	824	J	K	M	BB	BB	BB	BB	BB	CB	CB	CB	CB	CB	CB	DD	DD	DD	DG	DH	DH	DH	DH	DH	DH	DH	DH	DH	DH	DH	DH	DH	DH	DH
1.0 μF	105	J	K	M	BB	BB	BB	BB	BB	CB	CB	CB	CB	CB	CB	DD	DD	DD	DG	DH	DH	DH	DH	DH	DH	DH	DH	DH	DH	DH	DH	DH	DH	DH
1.2 μF	125	J	K	M	BB	BB	BB	BB	BB	CB	CB	CB	CB	CB	CB	DE	DE	DE	DE	DE	DE	DE	DE	DE	DE	DE	DE	DE	DE	DE	DE	DE	DE	DE
1.5 μF	155	J	K	M	BB	BB	BB	BB	BB	CB	CB	CB	CB	CB	CB	DG	DG	DG	DG	DG	DG	DG	DG	DG	DG	DG	DG	DG	DG	DG	DG	DG	DG	DG
1.8 μF	185	J	K	M	BB	BB	BB	BB	BB	CB	CB	CB	CB	CB	CB	DG	DG	DG	DG	DG	DG	DG	DG	DG	DG	DG	DG	DG	DG	DG	DG	DG	DG	DG
2.2 μF	225	J	K	M	BB	BB	BB	BB	BB	CB	CB	CB	CB	CB	CB	DG	DG	DG	DG	DG	DG	DG	DG	DG	DG	DG	DG	DG	DG	DG	DG	DG	DG	DG
2.7 μF	275	J	K	M	BB	BB	BB	BB	BB	CB	CB	CB	CB	CB	CB	DG	DG	DG	DG	DG	DG	DG	DG	DG	DG	DG	DG	DG	DG	DG	DG	DG	DG	DG
3.3 μF	335	J	K	M	BB	BB	BB	BB	BB	CB	CB	CB	CB	CB	CB	EH	EH	EH	EH	EH	EH	EH	EH	EH	EH	EH	EH	EH	EH	EH	EH	EH	EH	EH
3.9 μF	395	J	K	M	BB	BB	BB	BB	BB	CB	CB	CB	CB	CB	CB	EH	EH	EH	EH	EH	EH	EH	EH	EH	EH	EH	EH	EH	EH	EH	EH	EH	EH	EH
4.7 μF	475	J	K	M	BB	BB	BB	BB	BB	CB	CB	CB	CB	CB	CB	EH	EH	EH	EH	EH	EH	EH	EH	EH	EH	EH	EH	EH	EH	EH	EH	EH	EH	EH
Capacitance	Cap Code	Rated Voltage (VDC)			6.3	10	16	25	50	6.3	10	16	25	50	100	200	6.3	10	16	25	50	100	200	250	6.3	10	16	25	50	100	200	250		
		Voltage Code			9	8	4	3	5	9	8	4	3	5	1	2	9	8	4	3	5	1	2	A	9	8	4	3	5	1	2	A		
		Series			C0402C					C0603C						C0805C							C1206C											

*Capacitance range Includes E24 decade values only. (i.e., 10, 11, 12, 13, 15, 16, 18, 20, 22, 24, 27, 30, 33, 36, 39, 43, 47, 51, 56, 62, 68, 75, 82 and 91)

**Capacitance range Includes E12 decade values only. (i.e., 10, 12, 15, 18, 22, 27, 33, 39, 47, 56, 68 and 82)

Table 1B – Capacitance Range/Selection Waterfall (1210 – 2220 Case Sizes) cont'd

Capacitance	Cap Code	Case Size / Series			C1210C									C1812C					C1825C				C2220C						
		Voltage Code			9	8	4	3	5	1	2	A	3	5	1	2	A	5	1	2	A	3	5	1	2	A			
		Rated Voltage (VDC)			6.3	10	16	25	50	100	200	250	25	50	100	200	250	50	100	200	250	25	50	100	200	250			
		Capacitance Tolerance			Product Availability and Chip Thickness Codes See Table 2 for Chip Thickness Dimensions																								
12,000 pF	123	J	K	M	FB	FB	FB	FB	FB	FB	FB	FB	FB	FB	GB	GB	GB	GB	GB					JE	JE	JE			
15,000 pF	153	J	K	M	FB	FB	FB	FB	FB	FB	FB	FB	FB	FB	GB	GB	GB	GB	GB					JE	JE	JE			
18,000 pF	183	J	K	M	FB	FB	FB	FB	FB	FB	FB	FB	FB	FB	GB	GB	GB	GB	GB					JE	JE	JE			
22,000 pF	223	J	K	M	FB	FB	FB	FB	FB	FB	FB	FB	FB	FB	GB	GB	GB	GB	GB	HB	HB	HB	HB	JE	JE	JE			
27,000 pF	273	J	K	M	FB	FB	FB	FB	FB	FB	FB	FB	FB	FB	GB	GB	GB	GB	GB	HB	HB	HB	HB	JE	JE	JE			
33,000 pF	333	J	K	M	FB	FB	FB	FB	FB	FB	FB	FB	FB	FB	GB	GB	GB	GB	GB	HB	HB	HB	HB	JB	JB	JB			
39,000 pF	393	J	K	M	FB	FB	FB	FB	FB	FB	FB	FB	FB	FB	GB	GB	GB	GB	GB	HB	HB	HB	HB	JB	JB	JB			
47,000 pF	473	J	K	M	FB	FB	FB	FB	FB	FB	FB	FB	FB	FB	GB	GB	GB	GB	GB	HB	HB	HB	HB	JB	JB	JB			
56,000 pF	563	J	K	M	FB	FB	FB	FB	FB	FB	FB	FC	FC	FC	GB	GB	GB	GB	GB	HB	HB	HB	HB	JB	JB	JB			
68,000 pF	683	J	K	M	FB	FB	FB	FB	FB	FB	FC	FC	FC	FC	GB	GB	GB	GB	GB	HB	HB	HB	HB	JB	JB	JB			
82,000 pF	823	J	K	M	FB	FB	FB	FB	FB	FC	FC	FC	FC	FC	GB	GB	GB	GB	GB	HB	HB	HB	HB	JB	JB	JC	JC	JC	
0.10 µF	104	J	K	M	FB	FB	FB	FB	FB	FD	FD	FD	FD	FD	GB	GB	GB	GB	GB	HB	HB	HB	HB	JB	JB	JC	JC	JC	
0.12 µF	124	J	K	M	FB	FB	FB	FB	FB	FD	FD	FD	FD	FD	GB	GB	GB	GB	GB	HB	HB	HB	HB	JB	JB	JC	JC	JC	
0.15 µF	154	J	K	M	FC	FC	FC	FC	FC	FD	FD	FD	FD	FD	GB	GB	GB	GE	GE	HB	HB	HB	HB	JB	JB	JC	JC	JC	
0.18 µF	184	J	K	M	FC	FC	FC	FC	FC	FD	FD	FD	FD	FD	GB	GB	GB	GG	GG	HB	HB	HB	HB	JB	JB	JC	JC	JC	
0.22 µF	224	J	K	M	FC	FC	FC	FC	FC	FD	FD	FD	FD	FD	GB	GB	GB	GG	GG	HB	HB	HB	HB	JB	JB	JC	JC	JC	
0.27 µF	274	J	K	M	FC	FC	FC	FC	FC	FD	FD	FD	FD	FD	GB	GB	GG	GG	GG	HB	HB	HB	HB	JC	JC	JC	JC	JC	
0.33 µF	334	J	K	M	FD	FD	FD	FD	FD	FD	FD	FD	FD	FD	GB	GB	GG	GG	GG	HB	HB	HB	HB	JC	JC	JC	JC	JC	
0.39 µF	394	J	K	M	FD	FD	FD	FD	FD	FD	FD	FD	FD	FD	GB	GB	GG	GG	GG	HD	HD	HD	HD	JC	JC	JC	JC	JC	
0.47 µF	474	J	K	M	FD	FD	FD	FD	FD	FD	FD	FD	FD	FD	GB	GB	GG	GJ	GJ	HD	HD	HD	HD	JC	JC	JC	JC	JC	
0.56 µF	564	J	K	M	FD	FD	FD	FD	FD	FF	FF	FF	FF	FF	GC	GC	GG			HD	HD	HD	HD	JC	JD	JD	JD	JD	
0.68 µF	684	J	K	M	FD	FD	FD	FD	FD	FG	FG	FG	FG	FG	GC	GC	GG			HD	HD	HD	HD	JC	JD	JD	JD	JD	
0.82 µF	824	J	K	M	FF	FF	FF	FF	FF	FL	FL	FL	FL	FL	GE	GE	GG			HF	HF	HF	HF	JC	JF	JF	JF	JF	
1.0 µF	105	J	K	M	FH	FH	FH	FH	FH	FM	FM	FM	FM	FM	GE	GE	GG			HF	HF	HF	HF	JC	JF	JF	JF	JF	
1.2 µF	125	J	K	M	FH	FH	FH	FH	FG						GC	GC	GG						JC	JC					
1.5 µF	155	J	K	M	FH	FH	FH	FH	FG															JC	JC				
1.8 µF	185	J	K	M	FH	FH	FH	FH	FG															JD	JD				
2.2 µF	225	J	K	M	FJ	FJ	FJ	FJ	FG						GO	GO								JF	JF				
2.7 µF	275	J	K	M	FE	FE	FE	FG	FH																				
3.3 µF	335	J	K	M	FF	FF	FF	FM	FM																				
3.9 µF	395	J	K	M	FG	FG	FG	FG	FK																				
4.7 µF	475	J	K	M	FC	FC	FC	FG	FS						GK	GK								JF	JF				
5.6 µF	565	J	K	M	FF	FF	FF	FH																					
6.8 µF	685	J	K	M	FG	FG	FG	FM																					
8.2 µF	825	J	K	M	FH	FH	FH	FK																					
10 µF	106	J	K	M	FH	FH	FH	FS							GK									JF	JO				
15 µF	156	J	K	M																				JO					
22 µF	226	J	K	M	FS	FS																		JO					
Capacitance	Cap Code	Rated Voltage (VDC)			6.3	10	16	25	50	100	200	250	25	50	100	200	250	50	100	200	250	25	50	100	200	250			
		Voltage Code			9	8	4	3	5	1	2	A	3	5	1	2	A	5	1	2	A	3	5	1	2	A			
		Series			C1210C									C1812C					C1825C				C2220C						

*Capacitance range Includes E24 decade values only. (i.e., 10, 11, 12, 13, 15, 16, 18, 20, 22, 24, 27, 30, 33, 36, 39, 43, 47, 51, 56, 62, 68, 75, 82 and 91)

**Capacitance range Includes E12 decade values only. (i.e., 10, 12, 15, 18, 22, 27, 33, 39, 47, 56, 68 and 82)

Table 2 – Chip Thickness/Packaging Quantities

Thickness Code	Case Size	Thickness ± Range (mm)	Paper Quantity		Plastic Quantity	
			7" Reel	13" Reel	7" Reel	13" Reel
BB	0402	0.50 ± 0.05	10,000	50,000	0	0
CB	0603	0.80 ± 0.07	4,000	10,000	0	0
CF	0603	0.80 ± 0.07*	4,000	15,000	0	0
DE	0805	0.70 ± 0.20	4,000	10,000	0	0
DC	0805	0.78 ± 0.10	4,000	10,000	0	0
DD	0805	0.90 ± 0.10	4,000	10,000	0	0
DG	0805	1.25 ± 0.15	0	0	2,500	10,000
DH	0805	1.25 ± 0.20	0	0	2,500	10,000
EB	1206	0.78 ± 0.10	4,000	10,000	4,000	10,000
EC	1206	0.90 ± 0.10	0	0	4,000	10,000
EN	1206	0.95 ± 0.10	0	0	4,000	10,000
ED	1206	1.00 ± 0.10	0	0	2,500	10,000
EE	1206	1.10 ± 0.10	0	0	2,500	10,000
EF	1206	1.20 ± 0.15	0	0	2,500	10,000
EM	1206	1.25 ± 0.15	0	0	2,500	10,000
EG	1206	1.60 ± 0.15	0	0	2,000	8,000
EH	1206	1.60 ± 0.20	0	0	2,000	8,000
FB	1210	0.78 ± 0.10	0	0	4,000	10,000
FC	1210	0.90 ± 0.10	0	0	4,000	10,000
FD	1210	0.95 ± 0.10	0	0	4,000	10,000
FE	1210	1.00 ± 0.10	0	0	2,500	10,000
FF	1210	1.10 ± 0.10	0	0	2,500	10,000
FG	1210	1.25 ± 0.15	0	0	2,500	10,000
FL	1210	1.40 ± 0.15	0	0	2,000	8,000
FH	1210	1.55 ± 0.15	0	0	2,000	8,000
FM	1210	1.70 ± 0.20	0	0	2,000	8,000
FJ	1210	1.85 ± 0.20	0	0	2,000	8,000
FK	1210	2.10 ± 0.20	0	0	2,000	8,000
FS	1210	2.50 ± 0.30	0	0	1,000	4,000
GB	1812	1.00 ± 0.10	0	0	1,000	4,000
GC	1812	1.10 ± 0.10	0	0	1,000	4,000
GD	1812	1.25 ± 0.15	0	0	1,000	4,000
GE	1812	1.30 ± 0.10	0	0	1,000	4,000
GH	1812	1.40 ± 0.15	0	0	1,000	4,000
GG	1812	1.55 ± 0.10	0	0	1,000	4,000
GK	1812	1.60 ± 0.20	0	0	1,000	4,000
GJ	1812	1.70 ± 0.15	0	0	1,000	4,000
GO	1812	2.50 ± 0.20	0	0	500	2,000
HB	1825	1.10 ± 0.15	0	0	1,000	4,000
HD	1825	1.30 ± 0.15	0	0	1,000	4,000
HF	1825	1.50 ± 0.15	0	0	1,000	4,000
JB	2220	1.00 ± 0.15	0	0	1,000	4,000
JC	2220	1.10 ± 0.15	0	0	1,000	4,000
JD	2220	1.30 ± 0.15	0	0	1,000	4,000
JE	2220	1.40 ± 0.15	0	0	1,000	4,000
JF	2220	1.50 ± 0.15	0	0	1,000	4,000
JO	2220	2.40 ± 0.15	0	0	500	2,000
Thickness Code	Case Size	Thickness ± Range (mm)	7" Reel	13" Reel	7" Reel	13" Reel
			Paper Quantity		Plastic Quantity	

Package quantity based on finished chip thickness specifications.

Table 3 – Chip Capacitor Land Pattern Design Recommendations per IPC–7351

EIA Size Code	Metric Size Code	Density Level A: Maximum (Most) Land Protrusion (mm)					Density Level B: Median (Nominal) Land Protrusion (mm)					Density Level C: Minimum (Least) Land Protrusion (mm)				
		C	Y	X	V1	V2	C	Y	X	V1	V2	C	Y	X	V1	V2
0402	1005	0.50	0.72	0.72	2.20	1.20	0.45	0.62	0.62	1.90	1.00	0.40	0.52	0.52	1.60	0.80
0603	1608	0.90	1.15	1.10	4.00	2.10	0.80	0.95	1.00	3.10	1.50	0.60	0.75	0.90	2.40	1.20
0805	2012	1.00	1.35	1.55	4.40	2.60	0.90	1.15	1.45	3.50	2.00	0.75	0.95	1.35	2.80	1.70
1206	3216	1.60	1.35	1.90	5.60	2.90	1.50	1.15	1.80	4.70	2.30	1.40	0.95	1.70	4.00	2.00
1210	3225	1.60	1.35	2.80	5.65	3.80	1.50	1.15	2.70	4.70	3.20	1.40	0.95	2.60	4.00	2.90
1210 ¹	3225	1.50	1.60	2.90	5.60	3.90	1.40	1.40	2.80	4.70	3.30	1.30	1.20	2.70	4.00	3.00
1812	4532	2.15	1.60	3.60	6.90	4.60	2.05	1.40	3.50	6.00	4.00	1.95	1.20	3.40	5.30	3.70
2220	5650	2.75	1.70	5.50	8.20	6.50	2.65	1.50	5.40	7.30	5.90	2.55	1.30	5.30	6.60	5.60

¹ Only for capacitance values $\geq 22 \mu\text{F}$

Density Level A: For low-density product applications. Recommended for wave solder applications and provides a wider process window for reflow solder processes. KEMET only recommends wave soldering of EIA 0603, 0805, and 1206 case sizes.

Density Level B: For products with a moderate level of component density. Provides a robust solder attachment condition for reflow solder processes.

Density Level C: For high component density product applications. Before adapting the minimum land pattern variations the user should perform qualification testing based on the conditions outlined in IPC Standard 7351 (IPC–7351).

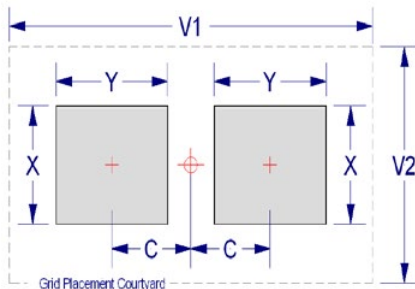

Soldering Process

Recommended Soldering Technique:

- Solder wave or solder reflow for EIA case sizes 0603, 0805 and 1206
- All other EIA case sizes are limited to solder reflow only

Recommended Reflow Soldering Profile:

KEMET's families of surface mount multilayer ceramic capacitors (SMD MLCCs) are compatible with wave (single or dual), convection, IR or vapor phase reflow techniques. Preheating of these components is recommended to avoid extreme thermal stress. KEMET's recommended profile conditions for convection and IR reflow reflect the profile conditions of the IPC/J-STD-020 standard for moisture sensitivity testing. These devices can safely withstand a maximum of three reflow passes at these conditions.

Profile Feature	Termination Finish	
	SnPb	100% Matte Sn
Preheat/Soak		
Temperature Minimum (T_{Smin})	100°C	150°C
Temperature Maximum (T_{Smax})	150°C	200°C
Time (t_s) from T_{Smin} to T_{Smax}	60 – 120 seconds	60 – 120 seconds
Ramp-Up Rate (T_L to T_p)	3°C/second maximum	3°C/second maximum
Liquidous Temperature (T_L)	183°C	217°C
Time Above Liquidous (t_L)	60 – 150 seconds	60 – 150 seconds
Peak Temperature (T_p)	235°C	260°C
Time Within 5°C of Maximum Peak Temperature (t_p)	20 seconds maximum	30 seconds maximum
Ramp-Down Rate (T_p to T_L)	6°C/second maximum	6°C/second maximum
Time 25°C to Peak Temperature	6 minutes maximum	8 minutes maximum

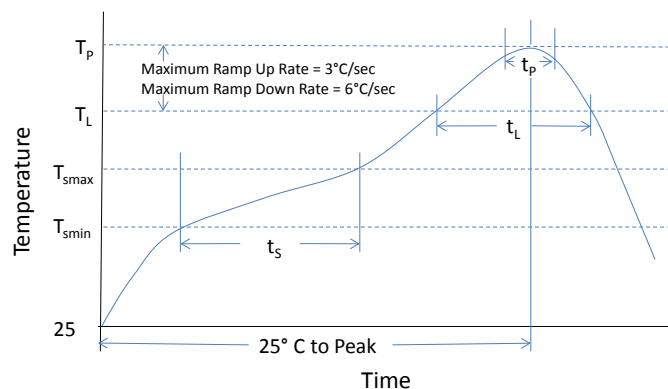

Note 1: All temperatures refer to the center of the package, measured on the capacitor body surface that is facing up during assembly reflow.

Table 4 – Performance & Reliability: Test Methods and Conditions

Stress	Reference	Test or Inspection Method
Terminal Strength	JIS-C-6429	Appendix 1, Note: Force of 1.8 kg for 60 seconds.
Board Flex	JIS-C-6429	Appendix 2, Note: Standard termination system – 2.0 mm (minimum) for all except 3 mm for COG. Flexible termination system – 3.0 mm (minimum).
Solderability	J-STD-002	Magnification 50 X. Conditions:
		a) Method B, 4 hours @ 155°C, dry heat @ 235°C
		b) Method B @ 215°C category 3
		c) Method D, category 3 @ 260°C
Temperature Cycling	JESD22 Method JA-104	1,000 Cycles (-55°C to +125°C). Measurement at 24 hours +/- 2 hours after test conclusion.
Biased Humidity	MIL-STD-202 Method 103	Load Humidity: 1,000 hours 85°C/85% RH and rated voltage. Add 100 K ohm resistor. Measurement at 24 hours +/- 2 hours after test conclusion.
		Low Volt Humidity: 1,000 hours 85°C/85% RH and 1.5 V. Add 100 K ohm resistor. Measurement at 24 hours +/- 2 hours after test conclusion.
Moisture Resistance	MIL-STD-202 Method 106	t = 24 hours/cycle. Steps 7a and 7b not required. Unpowered. Measurement at 24 hours +/- 2 hours after test conclusion.
Thermal Shock	MIL-STD-202 Method 107	-55°C/+125°C. Note: Number of cycles required – 300, maximum transfer time – 20 seconds, dwell time – 15 minutes. Air – Air.
High Temperature Life	MIL-STD-202 Method 108 /EIA-198	1,000 hours at 125°C (85°C for X5R, Z5U and Y5V) with 2 X rated voltage applied.
Storage Life	MIL-STD-202 Method 108	150°C, 0 VDC for 1,000 hours.
Vibration	MIL-STD-202 Method 204	5 g's for 20 min., 12 cycles each of 3 orientations. Note: Use 8" X 5" PCB 0.031" thick 7 secure points on one long side and 2 secure points at corners of opposite sides. Parts mounted within 2" from any secure point. Test from 10 – 2,000 Hz
Mechanical Shock	MIL-STD-202 Method 213	Figure 1 of Method 213, Condition F.
Resistance to Solvents	MIL-STD-202 Method 215	Add aqueous wash chemical, OKEM Clean or equivalent.

Storage & Handling

Ceramic chip capacitors should be stored in normal working environments. While the chips themselves are quite robust in other environments, solderability will be degraded by exposure to high temperatures, high humidity, corrosive atmospheres, and long term storage. In addition, packaging materials will be degraded by high temperature– reels may soften or warp and tape peel force may increase. KEMET recommends that maximum storage temperature not exceed 40°C and maximum storage humidity not exceed 70% relative humidity. Temperature fluctuations should be minimized to avoid condensation on the parts and atmospheres should be free of chlorine and sulfur bearing compounds. For optimized solderability chip stock should be used promptly, preferably within 1.5 years of receipt.

Telecom “Tip and Ring” X7R Dielectric, 250 VDC (Commercial Grade)

Overview

KEMET’s 250 V DC Tip and Ring MLCCs in X7R dielectric are designed and rated for telecommunication ringer circuits where the capacitor is used to block -48 V to -52 V DC of line voltage and pass a 16 – 25 Hz AC signal pulse of 70 VRMs to 90 VRMs. Serving as an excellent replacement for high voltage leaded film devices, these smaller surface mount technology footprints save valuable board space which is critical when creating new designs.

KEMET Tip and Ring capacitors feature a 125°C maximum operating temperature and are considered “temperature stable.” The Electronics Components, Assemblies & Materials Association (EIA) characterizes X7R dielectric as a Class II

material. Components of this classification are fixed, ceramic dielectric capacitors suited for bypass and decoupling applications or for frequency discriminating circuits where Q and stability of capacitance characteristics are not critical. X7R dielectric exhibits a predictable change in capacitance with respect to time and voltage and boasts a minimal change in capacitance with reference to ambient temperature. Capacitance change is limited to $\pm 15\%$ from -55°C to +125°C.

These devices are able to withstand today’s higher lead-free reflow processing temperatures and offer superior high frequency filtering characteristics and low ESR.

Benefits

- -55°C to +125°C operating temperature range
- Pb-Free and RoHS Compliant
- EIA 0805, 1206, 1210, 1812, 1825, 2220, and 2225 case sizes
- DC voltage rating of 250 V
- Capacitance offerings ranging from 1,000 pF to 6.8 μ F
- Available capacitance tolerances of $\pm 10\%$ and $\pm 20\%$
- Non-polar device, minimizing installation concerns
- 100% pure matte tin-plated termination finish that allows for excellent solderability
- SnPb termination finish option available upon request (5% minimum)
- Flexible termination option available upon request

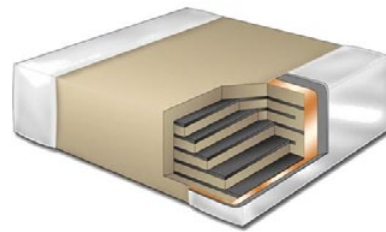

Ordering Information

C	1825	C	105	K	A	R	A	C	TU
Ceramic	Case Size (L" x W")	Specification/ Series	Capacitance Code (pF)	Capacitance Tolerance	Voltage	Dielectric	Failure Rate/ Design	Termination Finish ¹	Packaging/Grade (C-Spec) ²
	0805 1206 1210 1812 1825 2220 2225	C = Standard X = Flexible Termination	2 Significant Digits + Number of Zeros	J = $\pm 5\%$ K = $\pm 10\%$ M = $\pm 20\%$	A = 250 V	R = X7R	A = N/A	C = 100% Matte Sn L = SnPb (5% minimum)	Blank = Bulk TU = 7" Reel Unmarked TM = 7" Reel Marked

¹ Additional termination finish options may be available. Contact KEMET for details.

² Additional reeling or packaging options may be available. Contact KEMET for details.

Dimensions – Millimeters (Inches) – Standard Termination

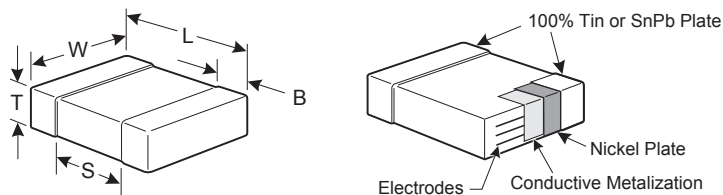

EIA Size Code	Metric Size Code	L Length	W Width	T Thickness	B Bandwidth	S Separation Minimum	Mounting Technique
0805	2012	2.00 (.079) ± 0.20 (.008)	1.25 (.049) ± 0.20 (.008)	See Table 2 for Thickness	0.50 (0.02) ± 0.25 (.010)	0.75 (.030)	Solder Wave or Solder Reflow
1206	3216	3.20 (.126) ± 0.20 (.008)	1.60 (.063) ± 0.20 (.008)		0.50 (0.02) ± 0.25 (.010)	N/A	
1210	3225	3.20 (.126) ± 0.20 (.008)	2.50 (.098) ± 0.20 (.008)		0.50 (0.02) ± 0.25 (.010)		Solder Reflow Only
1812	4532	4.50 (.177) ± 0.30 (.012)	3.20 (.126) ± 0.30 (.012)		0.60 (.024) ± 0.35 (.014)		
1825	4564	4.50 (.177) ± 0.30 (.012)	6.40 (.252) ± 0.40 (.016)		0.60 (.024) ± 0.35 (.014)		
2220	5650	5.70 (.224) ± 0.40 (.016)	5.00 (.197) ± 0.40 (.016)		0.60 (.024) ± 0.35 (.014)		
2225	5664	5.60 (.220) ± 0.40 (.016)	6.40 (.248) ± 0.40 (.016)		0.60 (.024) ± 0.35 (.014)		

Dimensions – Millimeters (Inches) – Flexible Termination

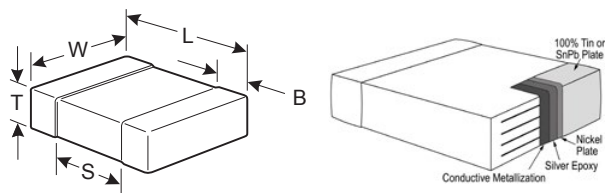

EIA Size Code	Metric Size Code	L Length	W Width	T Thickness	B Bandwidth	S Separation Minimum	Mounting Technique
0805	2012	2.00 (.079) ± 0.20 (.008)	1.25 (.049) ± 0.20 (.008)	See Table 2 for Thickness	0.50 (0.02) ± 0.25 (.010)	0.75 (.030)	Solder Wave or Solder Reflow
1206	3216	3.30 (.130) ± 0.40 (.016)	1.60 (.063) ± 0.20 (.008)		0.60 (.024) ± 0.25 (.010)	N/A	
1210	3225	3.30 (.130) ± 0.40 (.016)	2.50 (.098) ± 0.20 (.008)		0.60 (.024) ± 0.25 (.010)		Solder Reflow Only
1812	4532	4.50 (.178) ± 0.40 (.016)	3.20 (.126) ± 0.30 (.012)		0.70 (.028) ± 0.35 (.014)		
1825	4564	4.60 (.181) ± 0.40 (.016)	6.40 (.252) ± 0.40 (.016)		0.70 (.028) ± 0.35 (.014)		
2220	5650	5.90 (.232) ± 0.75 (.030)	5.00 (.197) ± 0.40 (.016)		0.70 (.028) ± 0.35 (.014)		
2225	5664	5.90 (.232) ± 0.75 (.030)	6.40 (.248) ± 0.40 (.016)		0.70 (.028) ± 0.35 (.014)		

Applications

Typical applications include telecommunication ringing circuits, switch mode power supply snubber circuits, high voltage DC blocking and high voltage coupling. Markets include telephone lines, analog and digital modems, facsimile machines, wireless base stations, cable and digital video recording set-top boxes, satellite dishes, high voltage power supply, DC/DC converters, and Ethernet, POS and ATM hardware.

Qualification/Certification

Commercial Grade products are subject to internal qualification. Details regarding test methods and conditions are referenced in Table 4, Performance & Reliability.

Environmental Compliance

Pb-Free and RoHS Compliant (excluding SnPb termination finish option).



RoHS Compliant

Electrical Parameters/Characteristics

Item	Parameters/Characteristics
Operating Temperature Range	-55°C to +125°C
Capacitance Change with Reference to +25°C and 0 VDC Applied (TCC)	±15%
Aging Rate (Maximum % Capacitance Loss/Decade Hour)	3.0%
Dielectric Withstanding Voltage (DWV)	250% of rated voltage (5 ±1 seconds and charge/discharge not exceeding 50 mA)
Dissipation Factor (DF) Maximum Limit @ 25°C	5% (6.3 and 10 V), 3.5% (16 and 25 V) and 2.5% (50 to 250 V)
Insulation Resistance (IR) Limit @ 25°C	See Insulation Resistance Limit Table (Rated voltage applied for 120 ±5 seconds @ 25°C)

Regarding aging rate: Capacitance measurements (including tolerance) are indexed to a referee time of 1,000 hours.

To obtain IR limit, divide $M\Omega \cdot \mu F$ value by the capacitance and compare to $G\Omega$ limit. Select the lower of the two limits.

Capacitance and dissipation factor (DF) measured under the following conditions:

1 kHz ±50 Hz and 1.0 ±0.2 Vrms if capacitance ≤ 10 μF

120 Hz ±10 Hz and 0.5 ±0.1 Vrms if capacitance >10 μF

Note: When measuring capacitance it is important to ensure the set voltage level is held constant. The HP4284 and Agilent E4980 have a feature known as Automatic Level Control (ALC). The ALC feature should be switched to "ON."

Post Environmental Limits

High Temperature Life, Biased Humidity, Moisture Resistance					
Dielectric	Rated DC Voltage	Capacitance Value	Dissipation Factor (Maximum %)	Capacitance Shift	Insulation Resistance
X7R	> 25	All	3.0	±20%	10% of Initial Limit
	16/25		5.0		
	< 16		7.5		

Insulation Resistance Limit Table

EIA Case Size	1,000 Megohm Microfarads or 100 GΩ	500 Megohm Microfarads or 10 GΩ
0201	N/A	ALL
0402	< 0.012 μF	≥ 0.012 μF
0603	< 0.047 μF	≥ 0.047 μF
0805	< 0.047 μF	≥ 0.047 μF
1206	< 0.22 μF	≥ 0.22 μF
1210	< 0.39 μF	≥ 0.39 μF
1808	ALL	N/A
1812	< 2.2 μF	≥ 2.2 μF
1825	ALL	N/A
2220	< 10 μF	≥ 10 μF
2225	ALL	N/A

Table 1 – Capacitance Range/Selection Waterfall (0805 – 2225 Case Sizes)

Capacitance	Capacitance Code	Case Size / Series			C0805C	C1206C	C1210C	C1812C	C1825C	C2220C	C2225C
		Voltage Code			A	A	A	A	A	A	A
		Rated Voltage (VDC)			250	250	250	250	250	250	250
		Capacitance Tolerance			Product Availability and Chip Thickness Codes See Table 2 for Chip Thickness Dimensions						
180 pF	181	J	K	M	DC						
220 pF	221	J	K	M	DC						
270 pF	271	J	K	M	DC						
330 pF	331	J	K	M	DC						
390 pF	391	J	K	M	DC						
470 pF	471	J	K	M	DC						
560 pF	561	J	K	M	DC						
680 pF	681	J	K	M	DC						
820 pF	821	J	K	M	DC						
1000 pF	102	J	K	M	DC	EB					
1200 pF	122	J	K	M	DC	EB					
1500 pF	152	J	K	M	DC	EB					
1800 pF	182	J	K	M	DC	EB					
2200 pF	222	J	K	M	DC	EB	FB				
2700 pF	272	J	K	M	DC	EB	FB				
3300 pF	332	J	K	M	DC	EB	FB				
3900 pF	392	J	K	M	DC	EB	FB				
4700 pF	472	J	K	M	DC	EB	FB				
5600 pF	562	J	K	M	DC	EB	FB				
6800 pF	682	J	K	M	DC	EB	FB	GB			
8200 pF	822	J	K	M	DC	EB	FB	GB			
10000 pF	103	J	K	M	DC	EB	FB	GB			
12000 pF	123	J	K	M	DC	EB	FB	GB			
15000 pF	153	J	K	M	DC	EB	FB	GB			
18000 pF	183	J	K	M	DC	EB	FB	GB			
22000 pF	223	J	K	M	DC	EB	FB	GB	HB		
27000 pF	273	J	K	M		EB	FB	GB	HB		
33000 pF	333	J	K	M		EB	FB	GB	HB		
39000 pF	393	J	K	M		EB	FB	GB	HB		
47000 pF	473	J	K	M		ED	FC	GB	HB		
56000 pF	563	J	K	M		ED	FC	GB	HB		
68000 pF	683	J	K	M		ED	FC	GB	HB		
82000 pF	823	J	K	M		ED	FF	GB	HB	JC	
0.1 µF	104	J	K	M		EM	FG	GB	HB	JC	KC
0.12 µF	124	J	K	M				GB	HB	JC	KC
0.15 µF	154	J	K	M				GE	HB	JC	KC
0.18 µF	184	J	K	M				GG	HB	JC	KC
0.22 µF	224	J	K	M				GG	HB	JC	KC
0.27 µF	274	J	K	M				GG	HB	JC	KC
0.33 µF	334	J	K	M				GG	HB	JC	KC
0.39 µF	394	J	K	M				GG	HD	JC	KC
0.47 µF	474	J	K	M				GJ	HD	JC	KD
0.56 µF	564	J	K	M					HD	JD	KD
0.68 µF	684	J	K	M					HD	JD	KD
0.82 µF	824	J	K	M					HF	JF	KE
1 µF	105	J	K	M					HF	JF	KE
1.2 µF	125	J	K	M							KE
Capacitance	Capacitance Code	Rated Voltage (VDC)			250	250	250	250	250	250	250
		Voltage Code			A	A	A	A	A	A	A
		Case Size / Series			C0805C	C1206C	C1210C	C1812C	C1825C	C2220C	C2225C

**Capacitance range Includes E12 decade values only. (i.e., 10, 12, 15, 18, 22, 27, 33, 39, 47, 56, 68 and 82)

Table 2 – Chip Thickness/Packaging Quantities

Thickness Code	Case Size	Thickness ± Range (mm)	Paper Quantity		Plastic Quantity	
			7" Reel	13" Reel	7" Reel	13" Reel
DC	0805	0.78 ± 0.10	4,000	10,000	0	0
EB	1206	0.78 ± 0.10	4,000	10,000	4,000	10,000
ED	1206	1.00 ± 0.10	0	0	2,500	10,000
EM	1206	1.25 ± 0.15	0	0	2,500	10,000
FB	1210	0.78 ± 0.10	0	0	4,000	10,000
FC	1210	0.90 ± 0.10	0	0	4,000	10,000
FF	1210	1.10 ± 0.10	0	0	2,500	10,000
FG	1210	1.25 ± 0.15	0	0	2,500	10,000
GB	1812	1.00 ± 0.10	0	0	1,000	4,000
GE	1812	1.30 ± 0.10	0	0	1,000	4,000
GG	1812	1.55 ± 0.10	0	0	1,000	4,000
GJ	1812	1.70 ± 0.15	0	0	1,000	4,000
HB	1825	1.10 ± 0.15	0	0	1,000	4,000
HD	1825	1.30 ± 0.15	0	0	1,000	4,000
HF	1825	1.50 ± 0.15	0	0	1,000	4,000
JC	2220	1.10 ± 0.15	0	0	1,000	4,000
JD	2220	1.30 ± 0.15	0	0	1,000	4,000
JF	2220	1.50 ± 0.15	0	0	1,000	4,000
KC	2225	1.10 ± 0.15	0	0	1,000	4,000
KD	2225	1.30 ± 0.15	0	0	1,000	4,000
KE	2225	1.40 ± 0.15	0	0	1,000	4,000
Thickness Code	Case Size	Thickness ± Range (mm)	7" Reel	13" Reel	7" Reel	13" Reel
			Paper Quantity		Plastic Quantity	

Package quantity based on finished chip thickness specifications.

Table 3A – Land Pattern Design Recommendations per IPC–7351 – Standard Termination

EIA Size Code	Metric Size Code	Density Level A: Maximum (Most) Land Protrusion (mm)					Density Level B: Median (Nominal) Land Protrusion (mm)					Density Level C: Minimum (Least) Land Protrusion (mm)				
		C	Y	X	V1	V2	C	Y	X	V1	V2	C	Y	X	V1	V2
0805	2012	1.00	1.35	1.55	4.40	2.60	0.90	1.15	1.45	3.50	2.00	0.75	0.95	1.35	2.80	1.70
1206	3216	1.60	1.35	1.90	5.60	2.90	1.50	1.15	1.80	4.70	2.30	1.40	0.95	1.70	4.00	2.00
1210	3225	1.60	1.35	2.80	5.65	3.80	1.50	1.15	2.70	4.70	3.20	1.40	0.95	2.60	4.00	2.90
1210 ¹	3225	1.50	1.60	2.90	5.60	3.90	1.40	1.40	2.80	4.70	3.30	1.30	1.20	2.70	4.00	3.00
1812	4532	2.15	1.60	3.60	6.90	4.60	2.05	1.40	3.50	6.00	4.00	1.95	1.20	3.40	5.30	3.70
1825	4564	2.15	1.60	6.90	6.90	7.90	2.05	1.40	6.80	6.00	7.30	1.95	1.20	6.70	5.30	7.00
2220	5650	2.75	1.70	5.50	8.20	6.50	2.65	1.50	5.40	7.30	5.90	2.55	1.30	5.30	6.60	5.60
2225	5664	2.70	1.70	6.90	8.10	7.90	2.60	1.50	6.80	7.20	7.30	2.50	1.30	6.70	6.50	7.00

¹ Only for capacitance values ≥ 22 μF

Table 3B – Land Pattern Design Recommendations per IPC–7351 – Flexible Termination

EIA Size Code	Metric Size Code	Density Level A: Maximum (Most) Land Protrusion (mm)					Density Level B: Median (Nominal) Land Protrusion (mm)					Density Level C: Minimum (Least) Land Protrusion (mm)				
		C	Y	X	V1	V2	C	Y	X	V1	V2	C	Y	X	V1	V2
0805	2012	1.00	1.35	1.55	4.40	2.60	0.90	1.15	1.45	3.50	2.00	0.80	0.95	1.35	2.80	1.70
1206	3216	1.60	1.65	1.90	5.90	2.90	1.50	1.45	1.80	5.00	2.30	1.40	1.25	1.70	4.30	2.00
1210	3225	1.60	1.65	2.80	5.90	3.80	1.50	1.45	2.70	5.00	3.20	1.40	1.25	2.60	4.30	2.90
1812	4532	2.10	1.80	3.60	7.00	4.60	2.00	1.60	3.50	6.10	4.00	1.90	1.40	3.40	5.40	3.70
1825	4564	2.15	1.80	6.90	7.10	7.90	2.05	1.60	6.80	6.20	7.30	1.95	1.40	6.70	5.50	7.00
2220	5650	2.85	2.10	5.50	8.80	6.50	2.75	1.90	5.40	7.90	5.90	2.65	1.70	5.30	7.20	5.60
2225	5664	2.85	2.10	6.90	8.80	7.90	2.75	1.90	6.80	7.90	7.30	2.65	1.70	6.70	7.20	7.00

Density Level A: For low-density product applications. Recommended for wave solder applications and provides a wider process window for reflow solder processes. KEMET only recommends wave soldering of EIA 0603, 0805 and 1206 case sizes.

Density Level B: For products with a moderate level of component density. Provides a robust solder attachment condition for reflow solder processes.

Density Level C: For high component density product applications. Before adapting the minimum land pattern variations the user should perform qualification testing based on the conditions outlined in IPC Standard 7351 (IPC–7351).

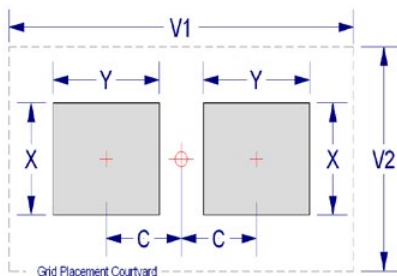

Soldering Process

Recommended Soldering Technique:

- Solder wave or solder reflow for EIA case sizes 0603, 0805 and 1206
- All other EIA case sizes are limited to solder reflow only

Recommended Soldering Profile:

- KEMET recommends following the guidelines outlined in IPC/JEDEC J–STD–020

Table 4 – Performance & Reliability: Test Methods and Conditions

Stress	Reference	Test or Inspection Method
Terminal Strength	JIS-C-6429	Appendix 1, Note: Force of 1.8 kg for 60 seconds.
Board Flex	JIS-C-6429	Appendix 2, Note: Standard termination system – 2.0 mm (minimum) for all except 3 mm for COG. Flexible termination system – 3.0 mm (minimum).
Solderability	J-STD-002	Magnification 50 X. Conditions:
		a) Method B, 4 hours @ 155°C, dry heat @ 235°C
		b) Method B @ 215°C category 3
		c) Method D, category 3 @ 260°C
Temperature Cycling	JESD22 Method JA-104	1,000 Cycles (-55°C to +125°C). Measurement at 24 hours +/- 2 hours after test conclusion.
Biased Humidity	MIL-STD-202 Method 103	Load Humidity: 1,000 hours 85°C/85% RH and rated voltage. Add 100 K ohm resistor. Measurement at 24 hours +/- 2 hours after test conclusion.
		Low Volt Humidity: 1,000 hours 85°C/85% RH and 1.5 V. Add 100 K ohm resistor. Measurement at 24 hours +/- 2 hours after test conclusion.
Moisture Resistance	MIL-STD-202 Method 106	t = 24 hours/cycle. Steps 7a and 7b not required. Unpowered. Measurement at 24 hours +/- 2 hours after test conclusion.
Thermal Shock	MIL-STD-202 Method 107	-55°C/+125°C. Note: Number of cycles required – 300, maximum transfer time – 20 seconds, dwell time – 15 minutes. Air – Air.
High Temperature Life	MIL-STD-202 Method 108 /EIA-198	1,000 hours at 125°C (85°C for X5R, Z5U and Y5V) with 2 X rated voltage applied.
Storage Life	MIL-STD-202 Method 108	150°C, 0 VDC for 1,000 hours.
Vibration	MIL-STD-202 Method 204	5 g's for 20 min., 12 cycles each of 3 orientations. Note: Use 8" X 5" PCB 0.031" thick 7 secure points on one long side and 2 secure points at corners of opposite sides. Parts mounted within 2" from any secure point. Test from 10 – 2,000 Hz
Mechanical Shock	MIL-STD-202 Method 213	Figure 1 of Method 213, Condition F.
Resistance to Solvents	MIL-STD-202 Method 215	Add aqueous wash chemical, OKEM Clean or equivalent.

Storage and Handling

Ceramic chip capacitors should be stored in normal working environments. While the chips themselves are quite robust in other environments, solderability will be degraded by exposure to high temperatures, high humidity, corrosive atmospheres, and long term storage. In addition, packaging materials will be degraded by high temperature– reels may soften or warp and tape peel force may increase. KEMET recommends that maximum storage temperature not exceed 40°C and maximum storage humidity not exceed 70% relative humidity. Temperature fluctuations should be minimized to avoid condensation on the parts and atmospheres should be free of chlorine and sulfur bearing compounds. For optimized solderability chip stock should be used promptly, preferably within 1.5 years of receipt.

Construction – Standard Termination

Reference	Item		Material	
A	Termination System	Finish	100% Matte Sn	SnPb (5% min)
B		Barrier Layer	Ni	
C		Base Metal	Cu	
D	Inner Electrode		Ni	
E	Dielectric Material		BaTiO ₃	

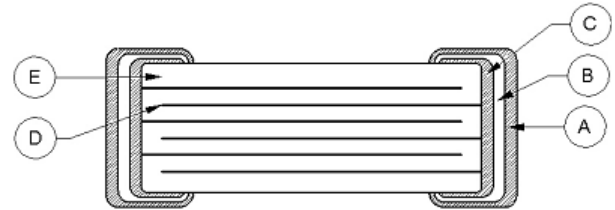

Note: Image is exaggerated in order to clearly identify all components of construction.

Construction – Flexible Termination

Reference	Item		Material	
A	Termination System	Finish	100% Matte Sn	SnPb (5% min)
B		Barrier Layer	Ni	
C		Epoxy Layer	Ag	
D	Base Metal		Cu	
E	Inner Electrode		Ni	
F	Dielectric Material		BaTiO ₃	

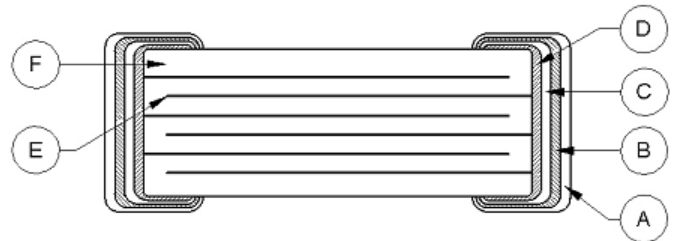

Note: Image is exaggerated in order to clearly identify all components of construction.

Open Mode Design (FO-CAP), X7R Dielectric, 16 – 200 VDC (Commercial & Automotive Grade)

Overview

KEMET's Ceramic Open Mode capacitor in X7R dielectric is designed to significantly minimize the probability of a low IR or short circuit condition when forced to failure in a board stress flex situation, thus reducing the potential for catastrophic failure. The Open Mode capacitor may experience a drop in capacitance; however, a short is unlikely because a crack will not typically propagate across counter electrodes within the device's "active area." Since there will not be any current leakage associated with a typical Open Mode flex crack, there is no localized heating and therefore little chance for a catastrophic and potentially costly failure event.

Driven by the demand for a more robust and reliable component, the Open Mode capacitor was designed for critical applications where higher operating temperatures and mechanical stress are a concern. These capacitors are widely used in automotive circuits as well as power supplies (input and output filters) and general electronic applications.

Concerned with flex cracks resulting from excessive tensile and shear stresses produced during board flexure and thermal cycling? These devices are available with KEMET's Flexible termination technology which inhibits the transfer of board stress to the rigid ceramic body, therefore mitigating flex cracks which can result in low IR or short circuit failures. Although flexible termination technology does not eliminate the potential for mechanical damage that may propagate during extreme environmental and handling conditions, it does provide superior flex performance over standard termination systems. When combined with flexible termination technology these devices offer the ultimate level of protection against a low IR or short circuit condition. Open Mode devices compliment KEMET's Floating Electrode (FE-CAP) and Floating Electrode with Flexible Termination (FF-CAP) product lines by providing a fail-safe design optimized for mid to high range capacitance values. These devices exhibit a predictable change in capacitance with respect to time and voltage and boast a minimal change in capacitance with reference to ambient temperature. Capacitance change is limited to $\pm 15\%$ from -55°C to $+125^{\circ}\text{C}$.

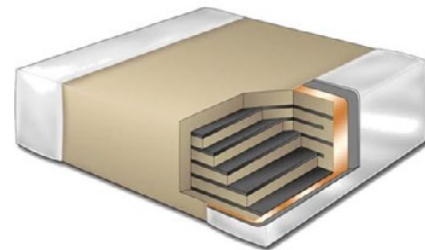

Ordering Information

C	1210	J	685	K	3	R	A	C	TU
Ceramic	Case Size (L" x W")	Specification/ Series	Capacitance Code (pF)	Capacitance Tolerance	Voltage	Dielectric	Failure Rate/ Design	Termination Finish ¹	Packaging/Grade (C-Spec) ²
	0805 1206 1210 1812	F = Open Mode J = Open Mode with Flexible Termination	2 Significant Digits + Number of Zeros	K = $\pm 10\%$ M = $\pm 20\%$	4 = 16 V 3 = 25 V 5 = 50 V 1 = 100 V 2 = 200 V	R = X7R	A = N/A	C = 100% Matte Sn L = SnPb (5% minimum)	Blank = Bulk TU = 7" Reel Unmarked TM = 7" Reel Marked AUTO = Automotive Grade

¹ Additional termination finish options may be available. Contact KEMET for details.

^{1,2} SnPb termination finish option is not available on automotive grade product.

² Additional reeling or packaging options may be available. Contact KEMET for details.

Dimensions – Millimeters (Inches) – Standard Termination

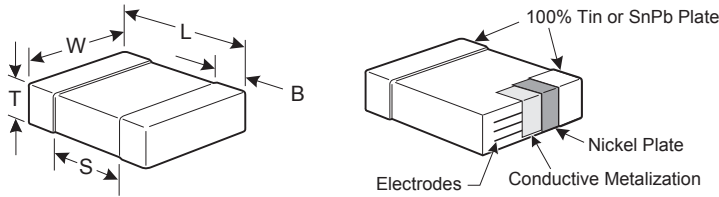

EIA Size Code	Metric Size Code	L Length	W Width	T Thickness	B Bandwidth	S Separation Minimum	Mounting Technique
0805	2012	2.00 (.079) ± 0.20 (.008)	1.25 (.049) ± 0.20 (.008)	See Table 2 for Thickness	0.50 (0.02) ± 0.25 (.010)	0.75 (.030)	Solder Wave or Solder Reflow
1206	3216	3.20 (.126) ± 0.20 (.008)	1.60 (.063) ± 0.20 (.008)		0.50 (0.02) ± 0.25 (.010)	N/A	
1210	3225	3.20 (.126) ± 0.20 (.008)	2.50 (.098) ± 0.20 (.008)		0.50 (0.02) ± 0.25 (.010)		Solder Reflow Only
1812	4532	4.50 (.177) ± 0.30 (.012)	3.20 (.126) ± 0.30 (.012)		0.60 (.024) ± 0.35 (.014)		

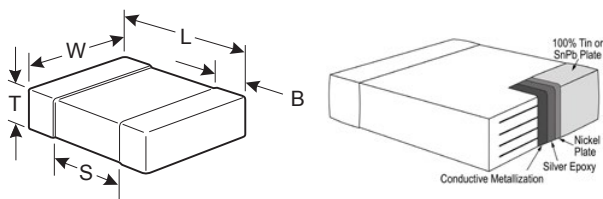

Dimensions – Millimeters (Inches) – Flexible Termination

EIA Size Code	Metric Size Code	L Length	W Width	T Thickness	B Bandwidth	S Separation Minimum	Mounting Technique
0805	2012	2.00 (.079) ± 0.20 (.008)	1.25 (.049) ± 0.20 (.008)	See Table 2 for Thickness	0.50 (0.02) ± 0.25 (.010)	0.75 (.030)	Solder Wave or Solder Reflow
1206	3216	3.30 (.130) ± 0.40 (.016)	1.60 (.063) ± 0.20 (.008)		0.60 (.024) ± 0.25 (.010)	N/A	
1210	3225	3.30 (.130) ± 0.40 (.016)	2.50 (.098) ± 0.20 (.008)		0.60 (.024) ± 0.25 (.010)		Solder Reflow Only
1812	4532	4.50 (.178) ± 0.40 (.016)	3.20 (.126) ± 0.30 (.012)		0.70 (.028) ± 0.35 (.014)		

Benefits

- -55°C to +125°C operating temperature range
- Open Mode/fail open design
- Mid to high capacitance flex mitigation
- Pb-Free and RoHS Compliant
- EIA 0805, 1206, 1210, and 1812 case sizes
- DC voltage ratings of 16 V, 25 V, 50 V, 100 V, and 200 V
- Capacitance offerings ranging from 1,000 pF to 6.8 µF
- Available capacitance tolerances of ±5%, ±10%, and ±20%
- Non-polar device, minimizing installation concerns
- 100% pure matte tin-plated termination finish allowing for excellent solderability
- Commercial and Automotive (AEC-Q200) grades available
- SnPb termination finish option available upon request (5% minimum)
- Flexible termination option available upon request

Applications

Typical applications include input side filtering (power plane/bus), high current (battery line) and circuits that cannot be fused to open when short circuits occur due to flex cracks. Markets include automotive applications that are directly connected to the battery and/or involve conversion to a 42 V system and raw power input side filtering in power conversion.

Qualification/Certification

Commercial Grade products are subject to internal qualification. Details regarding test methods and conditions are referenced in Table 4, Performance and Reliability.

Automotive Grade products meet or exceed the requirements outlined by the Automotive Electronics Council. Details regarding test methods and conditions are referenced in document AEC-Q200, Stress Test Qualification for Passive Components. For additional information regarding the Automotive Electronics Council and AEC-Q200, please visit their website at www.aecouncil.com.

Environmental Compliance

Pb-Free and RoHS Compliant (excluding SnPb termination finish option).



RoHS Compliant

Electrical Parameters/Characteristics

Item	Parameters/Characteristics
Operating Temperature Range	-55°C to +125°C
Capacitance Change with Reference to +25°C and 0 VDC Applied (TCC)	±15%
Aging Rate (Maximum % Capacitance Loss/Decade Hour)	3.0%
Dielectric Withstanding Voltage (DWV)	250% of rated voltage (5 ±1 seconds and charge/discharge not exceeding 50 mA)
Dissipation Factor (DF) Maximum Limit @ 25°C	5% (6.3 and 10 V), 3.5% (16 and 25 V) and 2.5% (50 to 250 V)
Insulation Resistance (IR) Limit @ 25°C	See Insulation Resistance Limit Table (Rated voltage applied for 120 ±5 seconds @ 25°C)

Regarding aging rate: Capacitance measurements (including tolerance) are indexed to a referee time of 1,000 hours.

To obtain IR limit, divide $M\Omega\text{-}\mu F$ value by the capacitance and compare to $G\Omega$ limit. Select the lower of the two limits.

Capacitance and dissipation factor (DF) measured under the following conditions:

1 kHz ±50 Hz and 1.0 ±0.2 Vrms if capacitance ≤ 10 μF

120 Hz ±10Hz and 0.5 ±0.1 Vrms if capacitance > 10 μF

Note: When measuring capacitance it is important to ensure the set voltage level is held constant. The HP4284 and Agilent E4980 have a feature known as Automatic Level Control (ALC). The ALC feature should be switched to "ON."

Post Environmental Limits

High Temperature Life, Biased Humidity, Moisture Resistance					
Dielectric	Rated DC Voltage	Capacitance Value	Dissipation Factor (Maximum %)	Capacitance Shift	Insulation Resistance
X7R	> 25	All	3.0	±20%	10% of Initial Limit
	16/25		5.0		
	< 16		7.5		

Insulation Resistance Limit Table (X7R Dielectric)

EIA Case Size	1,000 Megohm Microfarads or 100 GΩ	500 Megohm Microfarads or 10 GΩ
0201	N/A	ALL
0402	< 0.012 μF	≥ 0.012 μF
0603	< 0.047 μF	≥ 0.047 μF
0805	< 0.047 μF	≥ 0.047 μF
1206	< 0.22 μF	≥ 0.22 μF
1210	< 0.39 μF	≥ 0.39 μF
1808	ALL	N/A
1812	< 2.2 μF	≥ 2.2 μF
1825	ALL	N/A
2220	< 10 μF	≥ 10 μF
2225	ALL	N/A

Table 1 – Capacitance Range/Selection Waterfall (0805 – 1812 Case Sizes)

Capacitance	Cap Code	Case Size / Series		C0805F					C1206F					C1210F					C1812F			
		Voltage Code		4	3	5	1	2	4	3	5	1	2	4	3	5	1	2	3	5	1	2
		Rated Voltage (VDC)		16	25	50	100	200	16	25	50	100	200	16	25	50	100	200	25	50	100	200
		Capacitance Tolerance		Product Availability and Chip Thickness Codes See Table 2 for Chip Thickness Dimensions																		
1,000 pF	102	K	M	DD	DD	DD	DD	DD														
1,200 pF	122	K	M	DD	DD	DD	DD	DD														
1,500 pF	152	K	M	DD	DD	DD	DD	DD														
1,800 pF	182	K	M	DD	DD	DD	DD	DD														
2,200 pF	222	K	M	DD	DD	DD	DD	DD														
2,700 pF	272	K	M	DD	DD	DD	DD	DD														
3,300 pF	332	K	M	DD	DD	DD	DD	DD														
3,900 pF	392	K	M	DD	DD	DD	DD	DD														
4,700 pF	472	K	M	DD	DD	DD	DD	DD														
5,600 pF	562	K	M	DD	DD	DD	DD	DD														
6,800 pF	682	K	M	DD	DD	DD	DD	DD														
8,200 pF	822	K	M	DD	DD	DD	DD	DD														
10,000 pF	103	K	M	DD	DD	DD	DD	DD														
12,000 pF	123	K	M	DD	DD	DD	DD	DD	DG													
15,000 pF	153	K	M	DD	DD	DD	DD	DD	DG													
18,000 pF	183	K	M	DD	DD	DD	DD	DD		EC	EC	EC	EC	EC								
22,000 pF	223	K	M	DD	DD	DD	DD	DG		EC	EC	EC	EC	EC								
27,000 pF	273	K	M	DD	DD	DD	DD	DG		EC	EC	EC	EC	EC								
33,000 pF	333	K	M	DD	DD	DD	DD	DG		EC	EC	EC	EC	EC								
39,000 pF	393	K	M	DD	DD	DD	DD	DG		EC	EC	EC	EC	EC								
47,000 pF	473	K	M	DD	DD	DD	DD	DE		EC	EC	EC	EC	EC	EG				GB	GB	GB	GB
56,000 pF	563	K	M	DD	DD	DD	DD			EC	EC	EC	EC	EC	EG				GB	GB	GB	GB
68,000 pF	683	K	M	DD	DD	DG	DD	DG		EC	EC	EC	EC	EC	EG	FD	FD	FD	FD	FD	FD	FD
82,000 pF	823	K	M	DD	DD	DG	DD	DG		EC	EC	EC	EC	EC	EG	FD	FD	FD	FD	FD	FD	FD
0.10 µF	104	K	M	DG	DD	DG	DD	DG		EC	EC	EC	EC	EC	EG	FD	FD	FD	FD	FD	FD	FD
0.12 µF	124	K	M	DG	DG					EC	EC	EC	EC	EC		FD	FD	FD	FD	FG		
0.15 µF	154	K	M	DG	DG					EC	EC	EC	EG			FD	FD	FD	FD	FH		
0.18 µF	184	K	M	DG	DG					EC	EC	EC	EG			FD	FD	FD	FD	FH		
0.22 µF	224	K	M	DG	DD	DG				EC	EC	EC	ED			FD	FD	FD	FG	FJ		
0.27 µF	274	K	M	DD	DD					EC	EC	EC				FD	FD	FD	FG			
0.33 µF	334	K	M	DD	DG					EG	EG	EG	EG			FD	FD	FD	FH			
0.39 µF	394	K	M	DD	DG					EG	EG					FD	FD	FG	FH			
0.47 µF	474	K	M	DE	DG					EG	EG	EC				FD	FD	FG	FJ			
0.56 µF	564	K	M							EG						FD	FD	FG	FR			
0.68 µF	684	K	M	DG						EG						FD	FG	FH	FR			
0.82 µF	824	K	M							EG						FD	FG	FH	FR			
1.0 µF	105	K	M							EG	EC	EH				FD	FH	FJ	FS			
1.2 µF	125	K	M													FG						
1.5 µF	155	K	M													FH						
1.8 µF	185	K	M													FH						
2.2 µF	225	K	M							EC	EH					FJ	FM	FM				
3.3 µF	335	K	M													FM						
4.7 µF	475	K	M							EH						FG	FM				GK	GK
6.8 µF	685	K	M													FS	FS					
Capacitance	Cap Code	Rated Voltage (VDC)		16	25	50	100	200	16	25	50	100	200	16	25	50	100	200	25	50	100	200
		Voltage Code		4	3	5	1	2	4	3	5	1	2	4	3	5	1	2	3	5	1	2
		Case Size / Series		C0805F					C1206F					C1210F					C1812F			

Table 2 – Chip Thickness/Packaging Quantities

Thickness Code	Case Size	Thickness ± Range (mm)	Paper Quantity		Plastic Quantity	
			7" Reel	13" Reel	7" Reel	13" Reel
DD	0805	0.90 ± 0.10	4,000	10,000	0	0
DE	0805	1.00 ± 0.10	0	0	2,500	10,000
DG	0805	1.25 ± 0.15	0	0	2,500	10,000
EC	1206	0.90 ± 0.10	0	0	4,000	10,000
ED	1206	1.00 ± 0.10	0	0	2,500	10,000
EG	1206	1.60 ± 0.15	0	0	2,000	8,000
EH	1206	1.60 ± 0.20	0	0	2,000	8,000
FD	1210	0.95 ± 0.10	0	0	4,000	10,000
FG	1210	1.25 ± 0.15	0	0	2,500	10,000
FH	1210	1.55 ± 0.15	0	0	2,000	8,000
FM	1210	1.70 ± 0.20	0	0	2,000	8,000
FJ	1210	1.85 ± 0.20	0	0	2,000	8,000
FR	1210	2.25 ± 0.20	0	0	2,000	8,000
FS	1210	2.50 ± 0.30	0	0	1,000	4,000
GB	1812	1.00 ± 0.10	0	0	1,000	4,000
GC	1812	1.10 ± 0.10	0	0	1,000	4,000
GD	1812	1.25 ± 0.15	0	0	1,000	4,000
GF	1812	1.50 ± 0.10	0	0	1,000	4,000
GK	1812	1.60 ± 0.20	0	0	1,000	4,000
GN	1812	1.70 ± 0.20	0	0	1,000	4,000
GL	1812	1.90 ± 0.20	0	0	500	2,000
GM	1812	2.00 ± 0.20	0	0	500	2,000
Thickness Code	Case Size	Thickness ± Range (mm)	7" Reel	13" Reel	7" Reel	13" Reel
			Paper Quantity		Plastic Quantity	

Package quantity based on finished chip thickness specifications.

Table 3A – Land Pattern Design Recommendations per IPC–7351 – Standard Termination

EIA Size Code	Metric Size Code	Density Level A: Maximum (Most) Land Protrusion (mm)					Density Level B: Median (Nominal) Land Protrusion (mm)					Density Level C: Minimum (Least) Land Protrusion (mm)				
		C	Y	X	V1	V2	C	Y	X	V1	V2	C	Y	X	V1	V2
0805	2012	1.00	1.35	1.55	4.40	2.60	0.90	1.15	1.45	3.50	2.00	0.75	0.95	1.35	2.80	1.70
1206	3216	1.60	1.35	1.90	5.60	2.90	1.50	1.15	1.80	4.70	2.30	1.40	0.95	1.70	4.00	2.00
1210	3225	1.60	1.35	2.80	5.65	3.80	1.50	1.15	2.70	4.70	3.20	1.40	0.95	2.60	4.00	2.90
1210 ¹	3225	1.50	1.60	2.90	5.60	3.90	1.40	1.40	2.80	4.70	3.30	1.30	1.20	2.70	4.00	3.00
1812	4532	2.15	1.60	3.60	6.90	4.60	2.05	1.40	3.50	6.00	4.00	1.95	1.20	3.40	5.30	3.70

¹ Only for capacitance values ≥ 22 μF

Density Level A: For low-density product applications. Recommended for wave solder applications and provides a wider process window for reflow solder processes. KEMET only recommends wave soldering of EIA 0603, 0805 and 1206 case sizes.

Density Level B: For products with a moderate level of component density. Provides a robust solder attachment condition for reflow solder processes.

Density Level C: For high component density product applications. Before adapting the minimum land pattern variations the user should perform qualification testing based on the conditions outlined in IPC Standard 7351 (IPC–7351).

Table 3B – Land Pattern Design Recommendations per IPC–7351 – Flexible Termination

EIA Size Code	Metric Size Code	Density Level A: Maximum (Most) Land Protrusion (mm)					Density Level B: Median (Nominal) Land Protrusion (mm)					Density Level C: Minimum (Least) Land Protrusion (mm)				
		C	Y	X	V1	V2	C	Y	X	V1	V2	C	Y	X	V1	V2
0805	2012	1.00	1.35	1.55	4.40	2.60	0.90	1.15	1.45	3.50	2.00	0.80	0.95	1.35	2.80	1.70
1206	3216	1.60	1.65	1.90	5.90	2.90	1.50	1.45	1.80	5.00	2.30	1.40	1.25	1.70	4.30	2.00
1210	3225	1.60	1.65	2.80	5.90	3.80	1.50	1.45	2.70	5.00	3.20	1.40	1.25	2.60	4.30	2.90
1812	4532	2.10	1.80	3.60	7.00	4.60	2.00	1.60	3.50	6.10	4.00	1.90	1.40	3.40	5.40	3.70

Density Level A: For low-density product applications. Recommended for wave solder applications and provides a wider process window for reflow solder processes. KEMET only recommends wave soldering of EIA 0603, 0805 and 1206 case sizes.

Density Level B: For products with a moderate level of component density. Provides a robust solder attachment condition for reflow solder processes.

Density Level C: For high component density product applications. Before adapting the minimum land pattern variations the user should perform qualification testing based on the conditions outlined in IPC Standard 7351 (IPC–7351).

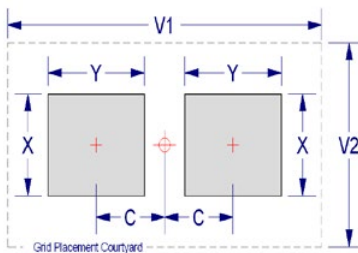

Soldering Process

Recommended Soldering Technique:

- Solder wave or solder reflow for EIA case sizes 0603, 0805 and 1206
- All other EIA case sizes are limited to solder reflow only

Recommended Soldering Profile:

- KEMET recommends following the guidelines outlined in IPC/JEDEC J–STD–020

Table 4 – Performance & Reliability: Test Methods and Conditions

Stress	Reference	Test or Inspection Method
Terminal Strength	JIS-C-6429	Appendix 1, Note: Force of 1.8 kg for 60 seconds.
Board Flex	JIS-C-6429	Appendix 2, Note: Standard termination system – 2.0 mm (minimum) for all except 3 mm for COG. Flexible termination system – 3.0 mm (minimum).
Solderability	J-STD-002	Magnification 50 X. Conditions:
		a) Method B, 4 hours @ 155°C, dry heat @ 235°C
		b) Method B @ 215°C category 3
		c) Method D, category 3 @ 260°C
Temperature Cycling	JESD22 Method JA-104	1,000 Cycles (-55°C to +125°C). Measurement at 24 hours +/- 2 hours after test conclusion.
Biased Humidity	MIL-STD-202 Method 103	Load Humidity: 1,000 hours 85°C/85% RH and rated voltage. Add 100 K ohm resistor. Measurement at 24 hours +/- 2 hours after test conclusion.
		Low Volt Humidity: 1,000 hours 85°C/85% RH and 1.5 V. Add 100 K ohm resistor. Measurement at 24 hours +/- 2 hours after test conclusion.
Moisture Resistance	MIL-STD-202 Method 106	t = 24 hours/cycle. Steps 7a and 7b not required. Unpowered. Measurement at 24 hours +/- 2 hours after test conclusion.
Thermal Shock	MIL-STD-202 Method 107	-55°C/+125°C. Note: Number of cycles required – 300, maximum transfer time – 20 seconds, dwell time – 15 minutes. Air – Air.
High Temperature Life	MIL-STD-202 Method 108 /EIA-198	1,000 hours at 125°C (85°C for X5R, Z5U and Y5V) with 2 X rated voltage applied.
Storage Life	MIL-STD-202 Method 108	150°C, 0 VDC for 1,000 hours.
Vibration	MIL-STD-202 Method 204	5 g's for 20 min., 12 cycles each of 3 orientations. Note: Use 8" X 5" PCB 0.031" thick 7 secure points on one long side and 2 secure points at corners of opposite sides. Parts mounted within 2" from any secure point. Test from 10 – 2,000 Hz
Mechanical Shock	MIL-STD-202 Method 213	Figure 1 of Method 213, Condition F.
Resistance to Solvents	MIL-STD-202 Method 215	Add aqueous wash chemical, OKEM Clean or equivalent.

Storage and Handling

Ceramic chip capacitors should be stored in normal working environments. While the chips themselves are quite robust in other environments, solderability will be degraded by exposure to high temperatures, high humidity, corrosive atmospheres, and long term storage. In addition, packaging materials will be degraded by high temperature– reels may soften or warp and tape peel force may increase. KEMET recommends that maximum storage temperature not exceed 40°C and maximum storage humidity not exceed 70% relative humidity. Temperature fluctuations should be minimized to avoid condensation on the parts and atmospheres should be free of chlorine and sulfur bearing compounds. For optimized solderability chip stock should be used promptly, preferably within 1.5 years of receipt.

Construction – Standard Termination

Reference	Item		Material	
A	Termination System	Finish	100% Matte Sn	SnPb (5% min)
B		Barrier Layer	Ni	
C		Base Metal	Cu	
D	Inner Electrode		Ni	
E	Dielectric Material		BaTiO ₃	

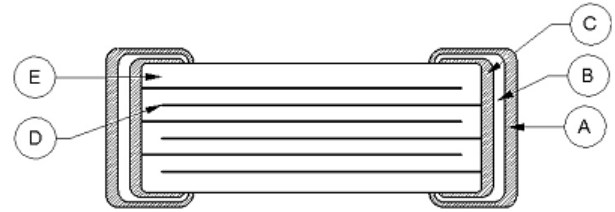

Note: Image is exaggerated in order to clearly identify all components of construction.

Construction – Flexible Termination

Reference	Item		Material	
A	Termination System	Finish	100% Matte Sn	SnPb (5% min)
B		Barrier Layer	Ni	
C		Epoxy Layer	Ag	
D		Base Metal	Cu	
E	Inner Electrode		Ni	
F	Dielectric Material		BaTiO ₃	

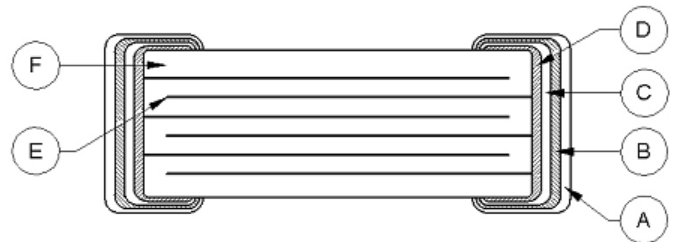

Note: Image is exaggerated in order to clearly identify all components of construction.

Floating Electrode Design (FE-CAP), X7R Dielectric, 6.3 – 250 VDC (Commercial & Automotive Grade)

Overview

KEMET's Floating Electrode (FE-CAP) multilayer ceramic capacitor in X7R dielectric utilizes a cascading internal electrode design configured to form multiple capacitors in series within a single monolithic structure. This unique configuration results in enhanced voltage and ESD performance over standard capacitor designs while allowing for a fail-open condition if mechanically damaged (cracked). If damaged, the device may experience a drop in capacitance but a short is unlikely. The FE-CAP is designed to reduce the likelihood of a low IR or short circuit condition and the chance for a catastrophic and potentially costly failure event.

Driven by the demand for a more robust and reliable component, the FE-CAP was designed for critical applications where higher operating temperatures and mechanical stress are a concern. These capacitors are manufactured in state of the

art ISO/TS 16949:2009 certified facilities and are widely used in power supplies (input and output filters) and general electronic applications.

Combined with the stability of an X7R dielectric, the FE-CAP complements KEMET's "Open Mode" devices by providing a fail-safe design optimized for low to mid range capacitance values. These devices exhibit a predictable change in capacitance with respect to time and voltage and boast a minimal change in capacitance with reference to ambient temperature. Capacitance change is limited to $\pm 15\%$ from -55°C to $+125^{\circ}\text{C}$.

In addition to Commercial Grade, Automotive Grade devices are available which meet the demanding Automotive Electronics Council's AEC-Q200 qualification requirements.

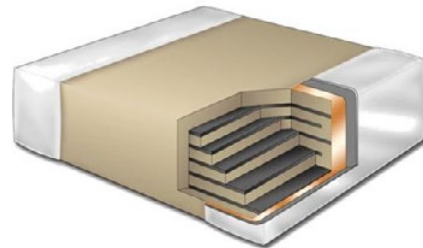

Ordering Information

C	0805	S	104	K	5	R	A	C	TU
Ceramic	Case Size (L" x W")	Specification/ Series	Capacitance Code (pF)	Capacitance Tolerance	Voltage	Dielectric	Failure Rate/ Design	Termination Finish ¹	Packaging/Grade (C-Spec) ²
	0402 0603 0805 1206 1210 1812	S = Floating Electrode	2 Significant Digits + Number of Zeros	J = $\pm 5\%$ K = $\pm 10\%$ M = $\pm 20\%$	9 = 6.3 V 8 = 10 V 4 = 16 V 3 = 25 V 5 = 50 V 1 = 100 V 2 = 200 V A = 250 V	R = X7R	A = N/A	C = 100% Matte Sn L = SnPb (5% minimum)	Blank = Bulk TU = 7" Reel Unmarked TM = 7" Reel Marked

¹ Additional termination finish options may be available. Contact KEMET for details.

^{1,2} SnPb termination finish option is not available on automotive grade product.

² Additional reeling or packaging options may be available. Contact KEMET for details.

Dimensions – Millimeters (Inches)

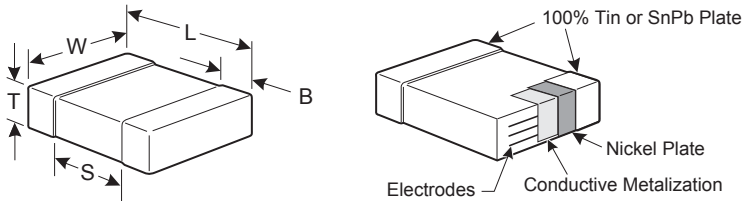

EIA Size Code	Metric Size Code	L Length	W Width	T Thickness	B Bandwidth	S Separation Minimum	Mounting Technique
0402	1005	1.00 (.040) ± 0.05 (.002)	0.50 (.020) ± 0.05 (.002)	See Table 2 for Thickness	0.30 (.012) ± 0.10 (.004)	0.30 (.012)	Solder Reflow Only
0603	1608	1.60 (.063) ± 0.15 (.006)	0.80 (.032) ± 0.15 (.006)		0.35 (.014) ± 0.15 (.006)	0.70 (.028)	Solder Wave or Solder Reflow
0805	2012	2.00 (.079) ± 0.20 (.008)	1.25 (.049) ± 0.20 (.008)		0.50 (0.02) ± 0.25 (.010)	0.75 (.030)	
1206	3216	3.20 (.126) ± 0.20 (.008)	1.60 (.063) ± 0.20 (.008)		0.50 (0.02) ± 0.25 (.010)	N/A	Solder Reflow Only
1210	3225	3.20 (.126) ± 0.20 (.008)	2.50 (.098) ± 0.20 (.008)		0.50 (0.02) ± 0.25 (.010)		
1812	4532	4.50 (.177) ± 0.30 (.012)	3.20 (.126) ± 0.30 (.012)		0.60 (.024) ± 0.35 (.014)		

Benefits

- -55°C to +125°C operating temperature range
- Floating Electrode/fail open design
- Low to mid capacitance flex mitigation
- Pb-Free and RoHS Compliant
- EIA 0402, 0603, 0805, 1206, 1210, and 1812 case sizes
- DC voltage ratings of 6.3 V, 10 V, 16 V, 25 V, 50 V, 100 V, 200 V, and 250 V
- Capacitance offerings ranging from 150 pF to 0.22 µF
- Available capacitance tolerances of ±5%, ±10%, and ±20%
- Commercial and Automotive (AEC-Q200) grades available
- Non-polar device, minimizing installation concerns
- 100% pure matte tin-plated termination finish allowing for excellent solderability
- SnPb termination finish option available upon request (5% minimum)

Applications

Typical applications include circuits with a direct battery or power source connection, critical and safety relevant circuits without (integrated) current limitation and any application that is subject to high levels of board flexure or temperature cycling. Examples include raw power input side filtering (power plane/bus), high current applications (automobile battery line) and circuits that cannot be fused to open. Markets include consumer, medical, industrial (power supply), automotive, aerospace and telecom.

Qualification/Certification

Commercial Grade products are subject to internal qualification. Details regarding test methods and conditions are referenced in Table 4 , Performance and Reliability.

Automotive Grade products meet or exceed the requirements outlined by the Automotive Electronics Council. Details regarding test methods and conditions are referenced in document AEC–Q200, Stress Test Qualification for Passive Components. For additional information regarding the Automotive Electronics Council and AEC–Q200, please visit their website at www.aecouncil.com.

Environmental Compliance

Pb-Free and RoHS Compliant (excluding SnPb termination finish option).



RoHS Compliant

Electrical Parameters/Characteristics

Item	Parameters/Characteristics
Operating Temperature Range	-55°C to +125°C
Capacitance Change with Reference to +25°C and 0 VDC Applied (TCC)	±15%
Aging Rate (Maximum % Capacitance Loss/Decade Hour)	3.0%
Dielectric Withstanding Voltage (DWV)	250% of rated voltage (5 ±1 seconds and charge/discharge not exceeding 50 mA)
Dissipation Factor (DF) Maximum Limit @ 25°C	5% (6.3 and 10 V), 3.5% (16 and 25 V) and 2.5% (50 to 250 V)
Insulation Resistance (IR) Limit @ 25°C	See Insulation Resistance Limit Table (Rated voltage applied for 120 ±5 seconds @ 25°C)

Regarding aging rate: Capacitance measurements (including tolerance) are indexed to a referee time of 1,000 hours.

To obtain IR limit, divide $M\Omega\text{-}\mu F$ value by the capacitance and compare to $G\Omega$ limit. Select the lower of the two limits.

Capacitance and dissipation factor (DF) measured under the following conditions:

1 kHz ±50 Hz and 1.0 ±0.2 Vrms if capacitance ≤ 10 μF

120 Hz ±10 Hz and 0.5 ±0.1 Vrms if capacitance > 10 μF

Note: When measuring capacitance it is important to ensure the set voltage level is held constant. The HP4284 and Agilent E4980 have a feature known as Automatic Level Control (ALC). The ALC feature should be switched to "ON."

Post Environmental Limits

High Temperature Life, Biased Humidity, Moisture Resistance					
Dielectric	Rated DC Voltage	Capacitance Value	Dissipation Factor (Maximum %)	Capacitance Shift	Insulation Resistance
X7R	> 25	All	3.0	±20%	10% of Initial Limit
	16/25		5.0		
	< 16		7.5		

Insulation Resistance Limit Table (X7R Dielectric)

EIA Case Size	1,000 Megohm Microfarads or 100 GΩ	500 Megohm Microfarads or 10 GΩ
0201	N/A	ALL
0402	< 0.012 μF	≥ 0.012 μF
0603	< 0.047 μF	≥ 0.047 μF
0805	< 0.047 μF	≥ 0.047 μF
1206	< 0.22 μF	≥ 0.22 μF
1210	< 0.39 μF	≥ 0.39 μF
1808	ALL	N/A
1812	< 2.2 μF	≥ 2.2 μF
1825	ALL	N/A
2220	< 10 μF	≥ 10 μF
2225	ALL	N/A

Table 1A – Capacitance Range/Selection Waterfall (0402 – 0805 Case Sizes)

Capacitance	Cap Code	Case Size / Series	C0402S					C0603S						C0805S												
		Voltage Code	9	8	4	3	5	9	8	4	3	5	1	2	9	8	4	3	5	1	2	A				
		Rated Voltage (VDC)	6.3	10	16	25	50	6.3	10	16	25	50	100	200	6.3	10	16	25	50	100	200	250				
		Capacitance Tolerance	Product Availability and Chip Thickness Codes See Table 2 for Chip Thickness Dimensions																							
150 pF	151	J	K	M	BB	BB	BB	BB	BB	CB	CB	CB	CB	CB	CB	CB	DC	DC	DC	DC	DC	DC	DC	DC	DC	DC
180 pF	181	J	K	M	BB	BB	BB	BB	BB	CB	CB	CB	CB	CB	CB	CB	DC	DC	DC	DC	DC	DC	DC	DC	DC	DC
220 pF	221	J	K	M	BB	BB	BB	BB	BB	CB	CB	CB	CB	CB	CB	CB	DC	DC	DC	DC	DC	DC	DC	DC	DC	DC
270 pF	271	J	K	M	BB	BB	BB	BB	BB	CB	CB	CB	CB	CB	CB	CB	DC	DC	DC	DC	DC	DC	DC	DC	DC	DC
330 pF	331	J	K	M	BB	BB	BB	BB	BB	CB	CB	CB	CB	CB	CB	CB	DC	DC	DC	DC	DC	DC	DC	DC	DC	DC
390 pF	391	J	K	M	BB	BB	BB	BB	BB	CB	CB	CB	CB	CB	CB	CB	DC	DC	DC	DC	DC	DC	DC	DC	DC	DC
470 pF	471	J	K	M	BB	BB	BB	BB	BB	CB	CB	CB	CB	CB	CB	CB	DC	DC	DC	DC	DC	DC	DC	DC	DC	DC
560 pF	561	J	K	M	BB	BB	BB	BB	BB	CB	CB	CB	CB	CB	CB	CB	DC	DC	DC	DC	DC	DC	DC	DC	DC	DC
680 pF	681	J	K	M	BB	BB	BB	BB	BB	CB	CB	CB	CB	CB	CB	CB	DC	DC	DC	DC	DC	DC	DC	DC	DC	DC
820 pF	821	J	K	M	BB	BB	BB	BB	BB	CB	CB	CB	CB	CB	CB	CB	DC	DC	DC	DC	DC	DC	DC	DC	DC	DC
1,000 pF	102	J	K	M	BB	BB	BB	BB	BB	CB	CB	CB	CB	CB	CF	CB	DC	DC	DC	DC	DC	DC	DC	DC	DC	DC
1,200 pF	122	J	K	M						CB	CB	CB	CB	CB	CB	CB	DC	DC	DC	DC	DC	DC	DC	DC	DC	DC
1,500 pF	152	J	K	M						CB	CB	CB	CB	CB	CB	CB	DC	DC	DC	DC	DC	DC	DC	DC	DC	DC
1,800 pF	182	J	K	M						CB	CB	CB	CB	CB	CB	CB	DC	DC	DC	DC	DC	DC	DC	DC	DC	DC
2,200 pF	222	J	K	M						CB	CB	CB	CB	CB	CF	CB	DC	DC	DC	DC	DC	DC	DC	DC	DC	DC
2,700 pF	272	J	K	M						CB	CB	CB	CB	CB	CB	CB	DC	DC	DC	DC	DC	DC	DC	DC	DC	DC
3,300 pF	332	J	K	M						CB	CB	CB	CB	CB	CB	CB	DC	DC	DC	DC	DC	DC	DC	DC	DC	DC
3,900 pF	392	J	K	M						CB	CB	CB	CB	CB	CB	CB	DC	DC	DC	DC	DC	DC	DC	DC	DC	DC
4,700 pF	472	J	K	M						CB	CB	CB	CB	CB	CB	CB	DC	DC	DC	DC	DC	DC	DC	DC	DC	DC
5,600 pF	562	J	K	M						CB	CB	CB	CB	CB	CB	CB	DC	DC	DC	DC	DC	DC	DC	DC	DC	DC
6,800 pF	682	J	K	M						CB	CB	CB	CB	CB	CB	CB	DC	DC	DC	DC	DC	DC	DC	DC	DC	DC
8,200 pF	822	J	K	M						CB	CB	CB	CB	CB	CB	CB	DC	DC	DC	DC	DC	DC	DC	DC	DC	DC
10,000 pF	103	J	K	M						CB	CB	CB	CB	CB	CF	CB	DC	DC	DC	DC	DC	DC	DC	DC	DC	DC
12,000 pF	123	J	K	M						CB	CB	CB	CB	CB	CB	CB	DC	DC	DC	DC	DC	DC	DC	DC	DC	DC
15,000 pF	153	J	K	M						CB	CB	CB	CB	CB	CB	CB	DC	DC	DC	DC	DC	DC	DC	DC	DC	DC
18,000 pF	183	J	K	M						CB	CB	CB	CB	CB	CB	CB	DC	DC	DC	DC	DC	DC	DC	DC	DC	DC
22,000 pF	223	J	K	M						CB	CB	CB	CB	CB	CB	CB	DC	DC	DC	DC	DC	DC	DC	DC	DC	DC
27,000 pF	273	J	K	M													DC	DC	DC	DC	DC	DC	DC	DC	DC	DC
33,000 pF	333	J	K	M													DC	DC	DC	DC	DC	DC	DC	DC	DC	DC
39,000 pF	393	J	K	M													DC	DC	DC	DC	DC	DC	DC	DC	DC	DC
47,000 pF	473	J	K	M													DC	DC	DC	DC	DC	DC	DC	DC	DC	DC
56,000 pF	563	J	K	M													DD	DD	DD	DD	DD	DD	DD	DD	DD	DD
68,000 pF	683	J	K	M													DD	DD	DD	DD	DD	DD	DD	DD	DD	DD
82,000 pF	823	J	K	M													DG	DG	DG	DG	DG	DG	DG	DG	DG	DG
0.10 µF	104	J	K	M													DG	DG	DG	DG	DG	DG	DG	DG	DG	DG
Capacitance	Cap Code	Rated Voltage (VDC)	6.3	10	16	25	50	6.3	10	16	25	50	100	200	6.3	10	16	25	50	100	200	250				
		Voltage Code	9	8	4	3	5	9	8	4	3	5	1	2	9	8	4	3	5	1	2	A				
		Case Size / Series	C0402S					C0603S						C0805S												

Table 2 – Chip Thickness/Packaging Quantities

Thickness Code	Case Size	Thickness ± Range (mm)	Paper Quantity		Plastic Quantity	
			7" Reel	13" Reel	7" Reel	13" Reel
BB	0402	0.50 ± 0.05	10,000	50,000	0	0
CB	0603	0.80 ± 0.07	4,000	10,000	0	0
CF	0603	0.80 ± 0.07	4,000	15,000	0	0
DC	0805	0.78 ± 0.10	4,000	10,000	0	0
DD	0805	0.90 ± 0.10	4,000	10,000	0	0
DG	0805	1.25 ± 0.15	0	0	2,500	10,000
EB	1206	0.78 ± 0.10	4,000	10,000	4,000	10,000
EC	1206	0.90 ± 0.10	0	0	4,000	10,000
FB	1210	0.78 ± 0.10	0	0	4,000	10,000
FC	1210	0.90 ± 0.10	0	0	4,000	10,000
FD	1210	0.95 ± 0.10	0	0	4,000	10,000
GB	1812	1.00 ± 0.10	0	0	1,000	4,000
Thickness Code	Case Size	Thickness ± Range (mm)	7" Reel	13" Reel	7" Reel	13" Reel
			Paper Quantity		Plastic Quantity	

Package quantity based on finished chip thickness specifications.

Table 3 – Chip Capacitor Land Pattern Design Recommendations per IPC–7351

EIA Size Code	Metric Size Code	Density Level A: Maximum (Most) Land Protrusion (mm)					Density Level B: Median (Nominal) Land Protrusion (mm)					Density Level C: Minimum (Least) Land Protrusion (mm)				
		C	Y	X	V1	V2	C	Y	X	V1	V2	C	Y	X	V1	V2
0402	1005	0.50	0.72	0.72	2.20	1.20	0.45	0.62	0.62	1.90	1.00	0.40	0.52	0.52	1.60	0.80
0603	1608	0.90	1.15	1.10	4.00	2.10	0.80	0.95	1.00	3.10	1.50	0.60	0.75	0.90	2.40	1.20
0805	2012	1.00	1.35	1.55	4.40	2.60	0.90	1.15	1.45	3.50	2.00	0.75	0.95	1.35	2.80	1.70
1206	3216	1.60	1.35	1.90	5.60	2.90	1.50	1.15	1.80	4.70	2.30	1.40	0.95	1.70	4.00	2.00
1210	3225	1.60	1.35	2.80	5.65	3.80	1.50	1.15	2.70	4.70	3.20	1.40	0.95	2.60	4.00	2.90
1210 ¹	3225	1.50	1.60	2.90	5.60	3.90	1.40	1.40	2.80	4.70	3.30	1.30	1.20	2.70	4.00	3.00
1812	4532	2.15	1.60	3.60	6.90	4.60	2.05	1.40	3.50	6.00	4.00	1.95	1.20	3.40	5.30	3.70

¹ Only for capacitance values ≥ 22 μF

Density Level A: For low-density product applications. Recommended for wave solder applications and provides a wider process window for reflow solder processes. KEMET only recommends wave soldering of EIA 0603, 0805 and 1206 case sizes.

Density Level B: For products with a moderate level of component density. Provides a robust solder attachment condition for reflow solder processes.

Density Level C: For high component density product applications. Before adapting the minimum land pattern variations the user should perform qualification testing based on the conditions outlined in IPC Standard 7351 (IPC–7351).

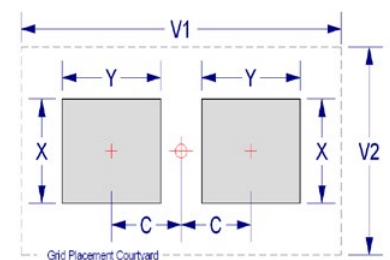

Soldering Process

Recommended Soldering Technique:

- Solder wave or solder reflow for EIA case sizes 0603, 0805 and 1206
- All other EIA case sizes are limited to solder reflow only

Recommended Soldering Profile:

- KEMET recommends following the guidelines outlined in IPC/JEDEC J–STD–020

Table 4 – Performance & Reliability: Test Methods and Conditions

Stress	Reference	Test or Inspection Method
Terminal Strength	JIS–C–6429	Appendix 1, Note: Force of 1.8 kg for 60 seconds.
Board Flex	JIS–C–6429	Appendix 2, Note: Standard termination system – 2.0 mm (minimum) for all except 3 mm for COG. Flexible termination system – 3.0 mm (minimum).
Solderability	J–STD–002	Magnification 50 X. Conditions:
		a) Method B, 4 hours @ 155°C, dry heat @ 235°C
		b) Method B @ 215°C category 3
		c) Method D, category 3 @ 260°C
Temperature Cycling	JESD22 Method JA–104	1,000 Cycles (-55°C to +125°C). Measurement at 24 hours +/- 2 hours after test conclusion.
Biased Humidity	MIL–STD–202 Method 103	Load Humidity: 1,000 hours 85°C/85% RH and rated voltage. Add 100 K ohm resistor. Measurement at 24 hours +/- 2 hours after test conclusion.
		Low Volt Humidity: 1,000 hours 85°C/85% RH and 1.5 V. Add 100 K ohm resistor. Measurement at 24 hours +/- 2 hours after test conclusion.
Moisture Resistance	MIL–STD–202 Method 106	t = 24 hours/cycle. Steps 7a and 7b not required. Unpowered. Measurement at 24 hours +/- 2 hours after test conclusion.
Thermal Shock	MIL–STD–202 Method 107	-55°C/+125°C. Note: Number of cycles required – 300, maximum transfer time – 20 seconds, dwell time – 15 minutes. Air – Air.
High Temperature Life	MIL–STD–202 Method 108 /EIA–198	1,000 hours at 125°C (85°C for X5R, Z5U and Y5V) with 2 X rated voltage applied.
Storage Life	MIL–STD–202 Method 108	150°C, 0 VDC for 1,000 hours.
Vibration	MIL–STD–202 Method 204	5 g's for 20 min., 12 cycles each of 3 orientations. Note: Use 8" X 5" PCB 0.031" thick 7 secure points on one long side and 2 secure points at corners of opposite sides. Parts mounted within 2" from any secure point. Test from 10 – 2,000 Hz
Mechanical Shock	MIL–STD–202 Method 213	Figure 1 of Method 213, Condition F.
Resistance to Solvents	MIL–STD–202 Method 215	Add aqueous wash chemical, OKEM Clean or equivalent.

Storage and Handling

Ceramic chip capacitors should be stored in normal working environments. While the chips themselves are quite robust in other environments, solderability will be degraded by exposure to high temperatures, high humidity, corrosive atmospheres, and long term storage. In addition, packaging materials will be degraded by high temperature– reels may soften or warp and tape peel force may increase. KEMET recommends that maximum storage temperature not exceed 40°C and maximum storage humidity not exceed 70% relative humidity. Temperature fluctuations should be minimized to avoid condensation on the parts and atmospheres should be free of chlorine and sulfur bearing compounds. For optimized solderability chip stock should be used promptly, preferably within 1.5 years of receipt.

Construction

Reference	Item		Material	
A	Termination System	Finish	100% Matte Sn	SnPb (5% min)
B		Barrier Layer	Ni	
C		Base Metal	Cu	
D	Inner Electrode		Ni	
E	Dielectric Material		BaTiO ₃	

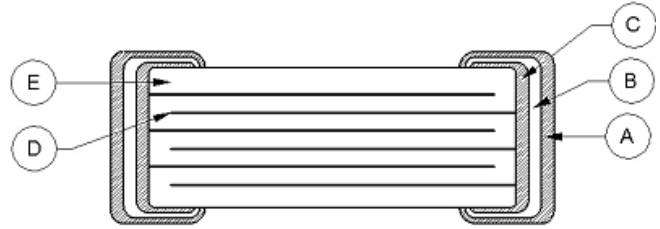

Note: Image is exaggerated in order to clearly identify all components of construction.

Flexible Termination System (FT-CAP), C0G Dielectric, 10 – 200 VDC (Commercial & Automotive Grade)

Overview

KEMET's Flexible Termination (FT-CAP) Multilayer Ceramic Capacitor in C0G dielectric incorporates a unique, flexible termination system that is integrated with KEMET's standard termination materials. A conductive silver epoxy is utilized between the base metal and nickel barrier layers of KEMET's standard termination system in order to establish pliability while maintaining terminal strength, solderability and electrical performance. This technology was developed in order to address the primary failure mode of MLCCs— flex cracks, which are typically the result of excessive tensile and shear stresses produced during board flexure and thermal cycling. Flexible termination technology inhibits the transfer of board stress to the rigid ceramic body, therefore mitigating flex cracks which can result in low IR or short circuit failures.

Although this technology does not eliminate the potential for mechanical damage that may propagate during extreme

environmental and handling conditions, it does provide superior flex performance over standard termination systems. FT-CAP complements KEMET's Open Mode, Floating Electrode (FE-CAP), Floating Electrode with Flexible Termination (FF-CAP), and KEMET Power Solutions (KPS) product lines by providing a complete portfolio of flex mitigation solutions.

Combined with the stability of C0G dielectric and designed to accommodate all capacitance requirements, these flex-robust devices are RoHS Compliant, offer up to 5 mm of flex-bend capability and exhibit no change in capacitance with respect to time and voltage. Capacitance change with reference to ambient temperature is limited to ± 30 ppm/°C from -55°C to +125°C.

In addition to Commercial Grade, Automotive Grade devices are available which meet the demanding Automotive Electronics Council's AEC-Q200 qualification requirements.

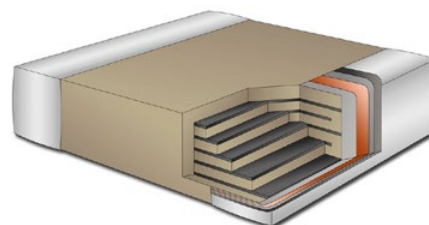

Ordering Information

C	1206	X	563	J	3	G	A	C	TU
Ceramic	Case Size (L" x W")	Specification/ Series	Capacitance Code (pF)	Capacitance Tolerance ¹	Rated Voltage (VDC)	Dielectric	Failure Rate/ Design	Termination Finish ²	Packaging/Grade (C-Spec) ³
	0603 0805 1206 1210 1812 1825 2220 2225	X = Flexible Termination	2 significant digits + number of zeros. Use 9 for 1.0 – 9.9 pF Use 8 for 0.5 – .99 pF e.g., 2.2 pF = 229 e.g., 0.5 pF = 508	B = ± 0.10 pF C = ± 0.25 pF D = ± 0.5 pF F = $\pm 1\%$ G = $\pm 2\%$ J = $\pm 5\%$ K = $\pm 10\%$ M = $\pm 20\%$	8 = 10 V 4 = 16 V 3 = 25 V 5 = 50 V 1 = 100 V 2 = 200 V	G = C0G	A = N/A	C = 100% Matte Sn L = SnPb (5% minimum)	Blank = Bulk TU = 7" Reel Unmarked AUTO = Automotive Grade 7" Reel Unmarked

¹ Additional capacitance tolerance offerings may be available. Contact KEMET for details.

² Additional termination finish options may be available. Contact KEMET for details.

^{2,3} SnPb termination finish option is not available on Automotive Grade product.

³ Additional reeling or packaging options may be available. Contact KEMET for details.

Dimensions – Millimeters (Inches)

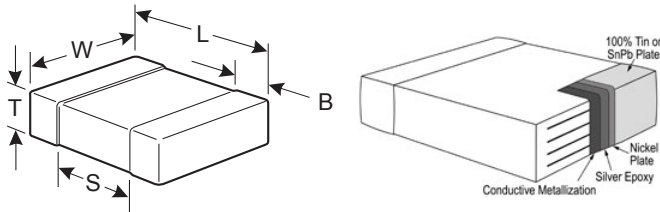

EIA Size Code	Metric Size Code	L Length	W Width	T Thickness	B Bandwidth	S Separation Minimum	Mounting Technique
0603	1608	1.60 (.064) ±0.17 (.007)	0.80 (.032) ±0.15 (.006)	See Table 2 for Thickness	0.45 (.018) ±0.15 (.006)	0.58 (.023)	Solder Wave or Solder Reflow
0805	2012	2.00 (.079) ±0.20 (.008)	1.25 (.049) ±0.20 (.008)		0.50 (0.02) ±0.25 (.010)	0.75 (.030)	
1206	3216	3.30 (.130) ±0.40 (.016)	1.60 (.063) ±0.20 (.008)		0.60 (.024) ±0.25 (.010)	N/A	Solder Reflow Only
1210	3225	3.30 (.130) ±0.40 (.016)	2.50 (.098) ±0.20 (.008)		0.60 (.024) ±0.25 (.010)		
1812	4532	4.50 (.178) ±0.40 (.016)	3.20 (.126) ±0.30 (.012)		0.70 (.028) ±0.35 (.014)		
1825	4564	4.60 (.181) ±0.40 (.016)	6.40 (.252) ±0.40 (.016)		0.70 (.028) ±0.35 (.014)		
2220	5650	5.90 (.232) ±0.75 (.030)	5.00 (.197) ±0.40 (.016)		0.70 (.028) ±0.35 (.014)		
2225	5664	5.90 (.232) ±0.75 (.030)	6.40 (.248) ±0.40 (.016)		0.70 (.028) ±0.35 (.014)		

Benefits

- -55°C to +125°C operating temperature range
- Superior flex performance (up to 5 mm)
- Pb-Free and RoHS Compliant
- EIA 0603, 0805, 1206, 1210, 1812, 1825, 2220, and 2225 case sizes
- DC voltage ratings of 10 V, 16 V, 25 V, 50 V, 100 V, and 200 V
- Capacitance offerings ranging from 0.5 pF up to 0.47 µF
- Available capacitance tolerances of ±0.10pF, ±0.25 pF, ±0.5 pF, ±1%, ±2%, ±5%, ±10%, and ±20%
- No piezoelectric noise
- Extremely low ESR and ESL
- High thermal stability
- High ripple current capability
- Preferred capacitance solution at line frequencies and into the MHz range
- No capacitance change with respect to applied rated DC voltage
- Negligible capacitance change with respect to temperature from -55°C to +125°C
- Non-polar device, minimizing installation concerns
- 100% pure matte tin-plated termination finish allowing for excellent solderability
- Commercial & Automotive (AEC-Q200) Grades available
- SnPb termination finish option available upon request (5% minimum)

Applications

Typical applications include critical timing, tuning, circuits requiring low loss, circuits with pulse, high current, decoupling, bypass, filtering, transient voltage suppression and blocking, as well as energy storage in critical and safety relevant circuits without (integrated) current limitation, including those subject to high levels of board flexure or temperature cycling.

Qualification/Certification

Commercial Grade products are subject to internal qualification. Details regarding test methods and conditions are referenced in Table 4, Performance & Reliability.

Automotive Grade products meet or exceed the requirements outlined by the Automotive Electronics Council. Details regarding test methods and conditions are referenced in document AEC-Q200, Stress Test Qualification for Passive Components. For additional information regarding the Automotive Electronics Council and AEC-Q200, please visit their website at www.aecouncil.com.

Environmental Compliance

Pb-Free and RoHS Compliant (excluding SnPb termination finish option).



RoHS Compliant

Electrical Parameters/Characteristics

Item	Parameters/Characteristics
Operating Temperature Range	-55°C to +125°C
Capacitance Change with Reference to +25°C and 0 VDC Applied (TCC)	±30 ppm/°C
Aging Rate (Maximum % Capacitance Loss/Decade Hour)	0%
Dielectric Withstanding Voltage (DWV)	250% of rated voltage (5 ±1 seconds and charge/discharge not exceeding 50 mA)
Dissipation Factor (DF) Maximum Limit @ 25°C	0.1%
Insulation Resistance (IR) Limit @ 25°C	1,000 megohm microfarads or 100 GΩ (Rated voltage applied for 120 ±5 seconds @ 25°C)

To obtain IR limit, divide MΩ-μF value by the capacitance and compare to GΩ limit. Select the lower of the two limits.

Capacitance and dissipation factor (DF) measured under the following conditions:

1 MHz ±100 kHz and 1.0 ±0.2 Vrms if capacitance ≤ 1,000 pF

1 kHz ±50 Hz and 1.0 ±0.2 Vrms if capacitance > 1,000 pF

Note: When measuring capacitance it is important to ensure the set voltage level is held constant. The HP4284 and Agilent E4980 have a feature known as Automatic Level Control (ALC). The ALC feature should be switched to "ON."

Post Environmental Limits

High Temperature Life, Biased Humidity, Moisture Resistance					
Dielectric	Rated DC Voltage	Capacitance Value	Dissipation Factor (Maximum %)	Capacitance Shift	Insulation Resistance
C0G	All	All	0.5	0.3% or ±0.25 pF	10% of Initial Limit

Table 1B – Capacitance Range/Selection Waterfall (1210 – 2225 Case Sizes)

Capacitance	Cap Code	Case Size / Series					C1210X					C1812X			C1825X			C2220X			C2225X						
		Voltage Code					8	4	3	5	1	2	5	1	2	5	1	2	5	1	2	5	1	2			
		Rated Voltage (VDC)					10	16	25	50	100	200	50	100	200	50	100	200	50	100	200	50	100	200			
		Capacitance Tolerance					Product Availability and Chip Thickness Codes See Table 2 for Chip Thickness Dimensions																				
1.0 - 9.1 pF*	109 - 919*	B	C	D	F	G	J	K	M	FB	FB	FB	FB	FB	FB												
10 - 91 pF*	100 - 910*				F	G	J	K	M	FB	FB	FB	FB	FB	FB												
100 - 430 pF*	101 - 431*				F	G	J	K	M	FB	FB	FB	FB	FB	FB												
470 - 910 pF*	471 - 911*				F	G	J	K	M	FB	FB	FB	FB	FB	FB	GB	GB	GB									
1,000 pF	102				F	G	J	K	M	FB	FB	FB	FB	FB	FB	GB	GB	GB									
1,100 pF	112				F	G	J	K	M	FB	FB	FB	FB	FB	FB	GB	GB	GB									
1,200 pF	122				F	G	J	K	M	FB	FB	FB	FB	FB	FB	GB	GB	GB									
1,300 pF	132				F	G	J	K	M	FB	FB	FB	FB	FB	FC	GB	GB	GB									
1,500 pF	152				F	G	J	K	M	FB	FB	FB	FB	FB	FE	GB	GB	GB									
1,600 pF	162				F	G	J	K	M	FB	FB	FB	FB	FB	FE	GB	GB	GB									
1,800 pF	182				F	G	J	K	M	FB	FB	FB	FB	FB	FE	GB	GB	GB									
2,000 pF	202				F	G	J	K	M	FB	FB	FB	FB	FC	FE	GB	GB	GB									
2,200 pF	222				F	G	J	K	M	FB	FB	FB	FB	FC	FG	GB	GB	GB									
2,400 pF	242				F	G	J	K	M	FB	FB	FB	FB	FC	FC												
2,700 pF	272				F	G	J	K	M	FB	FB	FB	FB	FC	FC	GB	GB	GB									
3,000 pF	302				F	G	J	K	M	FB	FB	FB	FB	FC	FF												
3,300 pF	332				F	G	J	K	M	FB	FB	FB	FB	FF	FF	GB	GB	GB									
3,600 pF	362				F	G	J	K	M	FB	FB	FB	FB	FF	FF												
3,900 pF	392				F	G	J	K	M	FB	FB	FB	FB	FF	FF	GB	GB	GB	HB	HB	HB						
4,300 pF	432				F	G	J	K	M	FB	FB	FB	FB	FF	FF												
4,700 pF	472				F	G	J	K	M	FF	FF	FF	FF	FG	FG	GB	GB	GD	HB	HB	HB				KE	KE	KE
5,100 pF	512				F	G	J	K	M	FB	FB	FB	FB	FG	FG										KE	KE	KE
5,600 pF	562				F	G	J	K	M	FB	FB	FB	FB	FG	FG	GB	GB	GH	HB	HB	HB				KE	KE	KE
6,200 pF	622				F	G	J	K	M	FB	FB	FB	FB	FG	FB										KE	KE	KE
6,800 pF	682				F	G	J	K	M	FB	FB	FB	FB	FG	FB	GB	GB	GJ	HB	HB	HB	JE	JE		KE	KE	KE
7,500 pF	752				F	G	J	K	M	FC	FC	FC	FC	FC	FB										KE	KE	KE
8,200 pF	822				F	G	J	K	M	FC	FC	FC	FC	FC	FB	GB	GH		HB	HB	HB	JE	JE		KE	KE	KE
9,100 pF	912				F	G	J	K	M	FE	FE	FE	FE	FE	FB										KE	KE	KE
10,000 pF	103				F	G	J	K	M	FF	FF	FF	FF	FF	FB	GB	GH		HB	HB	HE	JE	JE		KE	KE	KE
12,000 pF	123				F	G	J	K	M	FG	FG	FG	FG	FG	FB	GB	GG		HB	HB	HE	JE	JE		KE	KE	KE
15,000 pF	153				F	G	J	K	M	FG	FG	FG	FG	FC	FC	GB	GG		HB	HB		JE	JE		KE	KE	KE
18,000 pF	183				F	G	J	K	M	FB	FB	FB	FB	FC	GB	GB			HB	HE		JE	JE		KE	KE	
22,000 pF	223				F	G	J	K	M	FB	FB	FB	FB	FF	GB	GB			HB	HE		JE	JB		KE	KE	
27,000 pF	273				F	G	J	K	M	FB	FB	FB	FB	FB	FG	GB	GB		HB	HG		JE	JB		KE	KE	
33,000 pF	333				F	G	J	K	M	FB	FB	FB	FB	FB	FH	GB	GB					JB	JB		KE		
39,000 pF	393				F	G	J	K	M	FB	FB	FB	FB	FE	FH	GB	GB					JB	JB				
47,000 pF	473				F	G	J	K	M	FB	FB	FB	FB	FE	FJ	GB	GB					JB	JB				
56,000 pF	563				F	G	J	K	M	FB	FB	FB	FB	FF		GB	GB					JB	JB				
68,000 pF	683				F	G	J	K	M	FB	FB	FB	FB	FC	FG	GB	GB					JB	JB				
82,000 pF	823				F	G	J	K	M	FC	FC	FC	FF	FH		GB	GB					JB	JB				
0.10 µF	104				F	G	J	K	M	FE	FE	FE	FG	FM		GB	GD					JB	JB				
0.12 µF	124				F	G	J	K	M	FG	FG	FG	FH			GB	GH					JB	JB				
0.15 µF	154				F	G	J	K	M	FH	FH	FH	FM			GD	GN					JB	JB				
0.18 µF	184				F	G	J	K	M	FJ	FJ	FJ				GH						JB	JD				
0.22 µF	224				F	G	J	K	M	FK	FK	FK				GK						JB	JD				
0.27 µF	274				F	G	J	K	M													JB	JF				
0.33 µF	334				F	G	J	K	M													JD	JG				
0.39 µF	394				F	G	J	K	M													JG					
0.47 µF	474				F	G	J	K	M													JG					
Capacitance	Capacitance Code	Rated Voltage (VDC)					10	16	25	50	100	200	50	100	200	50	100	200	50	100	200	50	100	200			
		Voltage Code					8	4	3	5	1	2	5	1	2	5	1	2	5	1	2	5	1	2			
		Case Size / Series					C1210X					C1812X			C1825X			C2220X			C2225X						

*Capacitance range Includes E24 decade values only. (i.e., 10, 11, 12, 13, 15, 16, 18, 20, 22, 24, 27, 30, 33, 36, 39, 43, 47, 51, 56, 62, 68, 75, 82 and 91)
These products are protected under US Patents 7,172,985 and 7,670,981, other patents pending, and any foreign counterparts.

Table 2 – Chip Thickness/Packaging Quantities

Thickness Code	Case Size	Thickness ± Range (mm)	Paper Quantity		Plastic Quantity	
			7" Reel	13" Reel	7" Reel	13" Reel
CB	0603	0.80 ± 0.07	4,000	10,000	0	0
CF	0603	0.80 ± 0.07	4,000	15,000	0	0
CH	0603	0.85 ± 0.07	4,000	10,000	0	0
DC	0805	0.78 ± 0.10	0	0	4,000	10,000
DD	0805	0.90 ± 0.10	0	0	4,000	10,000
DE	0805	1.00 ± 0.10	0	0	2,500	10,000
DF	0805	1.10 ± 0.10	0	0	2,500	10,000
DG	0805	1.25 ± 0.15	0	0	2,500	10,000
EB	1206	0.78 ± 0.10	4,000	10,000	4,000	10,000
EC	1206	0.90 ± 0.10	0	0	4,000	10,000
ED	1206	1.00 ± 0.10	0	0	2,500	10,000
EE	1206	1.10 ± 0.10	0	0	2,500	10,000
EF	1206	1.20 ± 0.15	0	0	2,500	10,000
EH	1206	1.60 ± 0.20	0	0	2,000	8,000
FB	1210	0.78 ± 0.10	0	0	4,000	10,000
FC	1210	0.90 ± 0.10	0	0	4,000	10,000
FE	1210	1.00 ± 0.10	0	0	2,500	10,000
FF	1210	1.10 ± 0.10	0	0	2,500	10,000
FG	1210	1.25 ± 0.15	0	0	2,500	10,000
FH	1210	1.55 ± 0.15	0	0	2,000	8,000
FM	1210	1.70 ± 0.20	0	0	2,000	8,000
FJ	1210	1.85 ± 0.20	0	0	2,000	8,000
FK	1210	2.10 ± 0.20	0	0	2,000	8,000
GB	1812	1.00 ± 0.10	0	0	1,000	4,000
GD	1812	1.25 ± 0.15	0	0	1,000	4,000
GH	1812	1.40 ± 0.15	0	0	1,000	4,000
GG	1812	1.55 ± 0.10	0	0	1,000	4,000
GK	1812	1.60 ± 0.20	0	0	1,000	4,000
GJ	1812	1.70 ± 0.15	0	0	1,000	4,000
GN	1812	1.70 ± 0.20	0	0	1,000	4,000
HB	1825	1.10 ± 0.15	0	0	1,000	4,000
HE	1825	1.40 ± 0.15	0	0	1,000	4,000
HG	1825	1.60 ± 0.20	0	0	1,000	4,000
JB	2220	1.00 ± 0.15	0	0	1,000	4,000
JD	2220	1.30 ± 0.15	0	0	1,000	4,000
JE	2220	1.40 ± 0.15	0	0	1,000	4,000
JF	2220	1.50 ± 0.15	0	0	1,000	4,000
JG	2220	1.70 ± 0.15	0	0	1,000	4,000
KE	2225	1.40 ± 0.15	0	0	1,000	4,000
Thickness Code	Case Size	Thickness ± Range (mm)	7" Reel	13" Reel	7" Reel	13" Reel
			Paper Quantity		Plastic Quantity	

Package quantity based on finished chip thickness specifications.

Table 3 – Chip Capacitor Land Pattern Design Recommendations per IPC–7351 (mm)

EIA Size Code	Metric Size Code	Density Level A: Maximum (Most) Land Protrusion (mm)					Density Level B: Median (Nominal) Land Protrusion (mm)					Density Level C: Minimum (Least) Land Protrusion (mm)				
		C	Y	X	V1	V2	C	Y	X	V1	V2	C	Y	X	V1	V2
0603	1608	0.85	1.25	1.10	4.00	2.10	0.75	1.05	1.00	3.10	1.50	0.65	0.85	0.90	2.40	1.20
0805	2012	1.00	1.35	1.55	4.40	2.60	0.90	1.15	1.45	3.50	2.00	0.80	0.95	1.35	2.80	1.70
1206	3216	1.60	1.65	1.90	5.90	2.90	1.50	1.45	1.80	5.00	2.30	1.40	1.25	1.70	4.30	2.00
1210	3225	1.60	1.65	2.80	5.90	3.80	1.50	1.45	2.70	5.00	3.20	1.40	1.25	2.60	4.30	2.90
1812	4532	2.10	1.80	3.60	7.00	4.60	2.00	1.60	3.50	6.10	4.00	1.90	1.40	3.40	5.40	3.70
1825	4564	2.15	1.80	6.90	7.10	7.90	2.05	1.60	6.80	6.20	7.30	1.95	1.40	6.70	5.50	7.00
2220	5650	2.85	2.10	5.50	8.80	6.50	2.75	1.90	5.40	7.90	5.90	2.65	1.70	5.30	7.20	5.60
2225	5664	2.85	2.10	6.90	8.80	7.90	2.75	1.90	6.80	7.90	7.30	2.65	1.70	6.70	7.20	7.00

Density Level A: For low-density product applications. Recommended for wave solder applications and provides a wider process window for reflow solder processes. KEMET only recommends wave soldering of EIA 0603, 0805, and 1206 case sizes.

Density Level B: For products with a moderate level of component density. Provides a robust solder attachment condition for reflow solder processes.

Density Level C: For high component density product applications. Before adapting the minimum land pattern variations the user should perform qualification testing based on the conditions outlined in IPC Standard 7351 (IPC–7351).

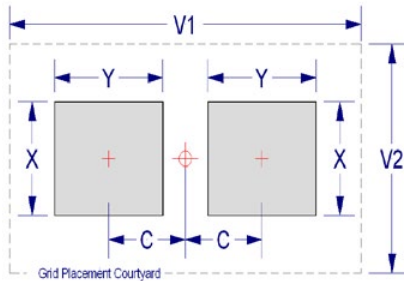

Soldering Process

Recommended Soldering Technique:

- Solder wave or solder reflow for EIA case sizes 0603, 0805, and 1206
- All other EIA case sizes are limited to solder reflow only

Recommended Soldering Profile:

- KEMET recommends following the guidelines outlined in IPC/JEDEC J–STD–020

Table 4 – Performance & Reliability: Test Methods and Conditions

Stress	Reference	Test or Inspection Method
Terminal Strength	JIS-C-6429	Appendix 1, Note: Force of 1.8 kg for 60 seconds.
Board Flex	JIS-C-6429	Appendix 2, Note: Standard termination system – 2.0 mm (minimum) for all except 3 mm for COG. Flexible termination system – 3.0 mm (minimum).
Solderability	J-STD-002	Magnification 50 X. Conditions:
		a) Method B, 4 hours @ 155°C, dry heat @ 235°C
		b) Method B @ 215°C category 3
		c) Method D, category 3 @ 260°C
Temperature Cycling	JESD22 Method JA-104	1,000 Cycles (-55°C to +125°C). Measurement at 24 hours +/- 2 hours after test conclusion.
Biased Humidity	MIL-STD-202 Method 103	Load Humidity: 1,000 hours 85°C/85% RH and rated voltage. Add 100 K ohm resistor. Measurement at 24 hours +/- 2 hours after test conclusion.
		Low Volt Humidity: 1,000 hours 85°C/85% RH and 1.5 V. Add 100 K ohm resistor. Measurement at 24 hours +/- 2 hours after test conclusion.
Moisture Resistance	MIL-STD-202 Method 106	t = 24 hours/cycle. Steps 7a and 7b not required. Unpowered. Measurement at 24 hours +/- 2 hours after test conclusion.
Thermal Shock	MIL-STD-202 Method 107	-55°C/+125°C. Note: Number of cycles required – 300, maximum transfer time – 20 seconds, dwell time – 15 minutes. Air – Air.
High Temperature Life	MIL-STD-202 Method 108 /EIA-198	1,000 hours at 125°C (85°C for X5R, Z5U and Y5V) with 2 X rated voltage applied.
Storage Life	MIL-STD-202 Method 108	150°C, 0 VDC for 1,000 hours.
Vibration	MIL-STD-202 Method 204	5 g's for 20 min., 12 cycles each of 3 orientations. Note: Use 8" X 5" PCB 0.031" thick 7 secure points on one long side and 2 secure points at corners of opposite sides. Parts mounted within 2" from any secure point. Test from 10 – 2,000 Hz
Mechanical Shock	MIL-STD-202 Method 213	Figure 1 of Method 213, Condition F.
Resistance to Solvents	MIL-STD-202 Method 215	Add aqueous wash chemical, OKEM Clean or equivalent.

Storage and Handling

Ceramic chip capacitors should be stored in normal working environments. While the chips themselves are quite robust in other environments, solderability will be degraded by exposure to high temperatures, high humidity, corrosive atmospheres, and long term storage. In addition, packaging materials will be degraded by high temperature– reels may soften or warp and tape peel force may increase. KEMET recommends that maximum storage temperature not exceed 40°C and maximum storage humidity not exceed 70% relative humidity. Temperature fluctuations should be minimized to avoid condensation on the parts and atmospheres should be free of chlorine and sulfur bearing compounds. For optimized solderability chip stock should be used promptly, preferably within 1.5 years of receipt.

Construction

Reference	Item	Material	
A	Termination System	Finish	100% Matte Sn
B		Barrier Layer	Ni
C		Epoxy Layer	Ag
D		Base Metal	Cu
E	Inner Electrode	Ni	
F	Dielectric Material	CaZrO ₃	

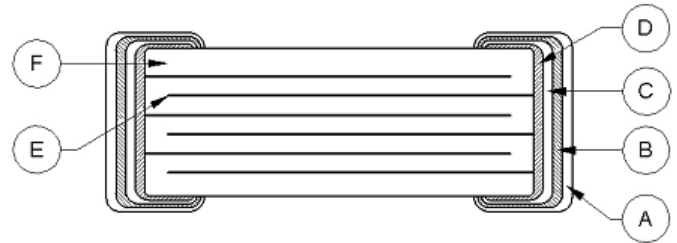

Note: Image is exaggerated in order to clearly identify all components of construction.

Capacitor Marking (Optional):

Laser marking option is not available on:

- COG, Ultra Stable X8R and Y5V dielectric devices
- EIA 0402 case size devices
- EIA 0603 case size devices with Flexible Termination option.
- KPS Commercial and Automotive grade stacked devices.

These capacitors are supplied unmarked only.

Flexible Termination System (FT-CAP) X7R Dielectric, 6.3 – 250 VDC (Commercial & Automotive Grade)

Overview

KEMET's Flexible Termination (FT-CAP) multilayer ceramic capacitor in X7R dielectric incorporates a unique, flexible termination system that is integrated with KEMET's standard termination materials. A conductive silver epoxy is utilized between the base metal and nickel barrier layers of KEMET's standard termination system in order to establish pliability while maintaining terminal strength, solderability and electrical performance. This technology was developed in order to address the primary failure mode of MLCCs— flex cracks, which are typically the result of excessive tensile and shear stresses produced during board flexure and thermal cycling. Flexible termination technology inhibits the transfer of board stress to the rigid ceramic body, therefore mitigating flex cracks which can result in low IR or short circuit failures.

Although this technology does not eliminate the potential for mechanical damage that may propagate during extreme

environmental and handling conditions, it does provide superior flex performance over standard termination systems. FT-CAP complements KEMET's Open Mode, Floating Electrode (FE-CAP), Floating Electrode with Flexible Termination (FF-CAP) and KEMET Power Solutions (KPS) product lines by providing a complete portfolio of flex mitigation solutions.

Combined with the stability of an X7R dielectric and designed to accommodate all capacitance requirements, these flex-robust devices are RoHS-compliant, offer up to 5mm of flex-bend capability and exhibit a predictable change in capacitance with respect to time and voltage. Capacitance change with reference to ambient temperature is limited to $\pm 15\%$ from -55°C to $+125^{\circ}\text{C}$.

In addition to commercial grade, automotive grade devices are available which meet the demanding Automotive Electronics Council's AEC-Q200 qualification requirements.

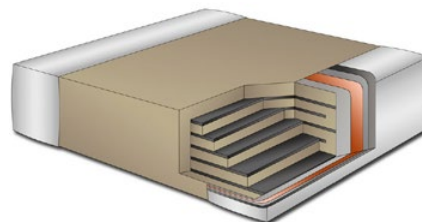

Ordering Information

C	1206	X	106	K	4	R	A	C	AUTO
Ceramic	Case Size (L" x W")	Specification/ Series	Capacitance Code (pF)	Capacitance Tolerance	Voltage	Dielectric	Failure Rate/ Design	Termination Finish ¹	Packaging/Grade (C-Spec) ²
	0603 0805 1206 1210 1808 1812 1825 2220 2225	X = Flexible Termination	2 significant digits + number of zeros	J = $\pm 5\%$ K = $\pm 10\%$ M = $\pm 20\%$	9 = 6.3 V 8 = 10 V 4 = 16 V 3 = 25 V 5 = 50 V 1 = 100 V 2 = 200 V A = 250 V	R = X7R	A = N/A	C = 100% Matte Sn L = SnPb (5% minimum)	Blank = Bulk TU = 7" Reel Unmarked TM = 7" Reel Marked AUTO = Automotive Grade 7" Reel Unmarked

¹ Additional termination finish options may be available. Contact KEMET for details.

^{1,2} SnPb termination finish option is not available on Automotive Grade product.

² Additional reeling or packaging options may be available. Contact KEMET for details.

Dimensions – Millimeters (Inches)

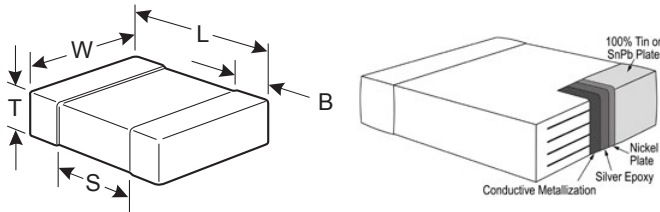

EIA Size Code	Metric Size Code	L Length	W Width	T Thickness	B Bandwidth	S Separation Minimum	Mounting Technique
0603	1608	1.60 (.064) ± 0.17 (.007)	0.80 (.032) ± 0.15 (.006)	See Table 2 for Thickness	0.45 (.018) ± 0.15 (.006)	0.58 (.023)	Solder Wave or Solder Reflow
0805	2012	2.00 (.079) ± 0.20 (.008)	1.25 (.049) ± 0.20 (.008)		0.50 (0.02) ± 0.25 (.010)	0.75 (.030)	
1206	3216	3.30 (.130) ± 0.40 (.016)	1.60 (.063) ± 0.20 (.008)		0.60 (.024) ± 0.25 (.010)	N/A	Solder Reflow Only
1210 ¹	3225	3.30 (.130) ± 0.40 (.016)	2.50 (.098) ± 0.20 (.008)		0.60 (.024) ± 0.25 (.010)		
1808	4520	4.70 (.185) ± 0.50 (.020)	2.00 (.079) ± 0.20 (.008)		0.70 (.028) ± 0.35 (.014)		
1812	4532	4.50 (.178) ± 0.40 (.016)	3.20 (.126) ± 0.30 (.012)		0.70 (.028) ± 0.35 (.014)		
1825	4564	4.60 (.181) ± 0.40 (.016)	6.40 (.252) ± 0.40 (.016)		0.70 (.028) ± 0.35 (.014)		
2220	5650	5.90 (.232) ± 0.75 (.030)	5.00 (.197) ± 0.40 (.016)		0.70 (.028) ± 0.35 (.014)		
2225	5664	5.90 (.232) ± 0.75 (.030)	6.40 (.248) ± 0.40 (.016)		0.70 (.028) ± 0.35 (.014)		

¹ For capacitance values ≥ 12 μF add 0.02 (0.001) to the width tolerance dimension

Benefits

- -55°C to +125°C operating temperature range
- Superior flex performance (up to 5 mm)
- High capacitance flex mitigation
- Pb-Free and RoHS Compliant
- EIA 0603, 0805, 1206, 1210, 1808, 1812, 1825, 2220, and 2225 case sizes
- DC voltage ratings of 6.3 V, 10 V, 16 V, 25 V, 50 V, 100 V, 200 V, and 250 V
- Capacitance offerings ranging from 180 pF to 22 μF
- Available capacitance tolerances of ±5%, ±10%, and ±20%
- Non-polar device, minimizing installation concerns
- 100% pure matte tin-plated termination finish allowing for excellent solderability
- SnPb termination finish option available upon request (5% min)
- Commercial and Automotive (AEC-Q200) grades available

Applications

Typical applications include circuits with a direct battery or power source connection, critical and safety relevant circuits without (integrated) current limitation and any application that is subject to high levels of board flexure or temperature cycling. Examples include raw power input side filtering (power plane/bus), high current applications (automobile battery line) and circuits that cannot be fused to open. Markets include consumer, medical, industrial (power supply), automotive, aerospace and telecom.

Qualification/Certification

Commercial Grade products are subject to internal qualification. Details regarding test methods and conditions are referenced in Table 4, Performance & Reliability.

Automotive Grade products meet or exceed the requirements outlined by the Automotive Electronics Council. Details regarding test methods and conditions are referenced in document AEC–Q200, Stress Test Qualification for Passive Components. For additional information regarding the Automotive Electronics Council and AEC–Q200, please visit their website at www.aecouncil.com.

Environmental Compliance

Pb-Free and RoHS Compliant (excluding SnPb termination finish option).



RoHS Compliant

Electrical Parameters/Characteristics

Item	Parameters/Characteristics
Operating Temperature Range	-55°C to +125°C
Capacitance Change with Reference to +25°C and 0 VDC Applied (TCC)	±15%
Aging Rate (Maximum % Capacitance Loss/Decade Hour)	3.0%
Dielectric Withstanding Voltage (DWV)	250% of rated voltage (5 ±1 seconds and charge/discharge not exceeding 50 mA)
Dissipation Factor (DF) Maximum Limit @ 25°C	5% (6.3 and 10 V), 3.5% (16 and 25 V) and 2.5% (50 to 250 V)
Insulation Resistance (IR) Limit @ 25°C	See Insulation Resistance Limit Table (Rated voltage applied for 120 ±5 seconds @ 25°C)

Regarding aging rate: Capacitance measurements (including tolerance) are indexed to a referee time of 1,000 hours.

To obtain IR limit, divide $M\Omega\text{-}\mu F$ value by the capacitance and compare to $G\Omega$ limit. Select the lower of the two limits.

Capacitance and dissipation factor (DF) measured under the following conditions:

1 kHz ±50 Hz and 1.0 ±0.2 Vrms if capacitance ≤ 10 μF

120 Hz ±10 Hz and 0.5 ±0.1 Vrms if capacitance > 10 μF

Note: When measuring capacitance it is important to ensure the set voltage level is held constant. The HP4284 and Agilent E4980 have a feature known as Automatic Level Control (ALC). The ALC feature should be switched to "ON."

Post Environmental Limits

High Temperature Life, Biased Humidity, Moisture Resistance					
Dielectric	Rated DC Voltage	Capacitance Value	Dissipation Factor (Maximum %)	Capacitance Shift	Insulation Resistance
X7R	> 25	All	3.0	±20%	10% of Initial Limit
	16/25		5.0		
	< 16		7.5		

Insulation Resistance Limit Table (X7R Dielectric)

EIA Case Size	1,000 Megohm Microfarads or 100 GΩ	500 Megohm Microfarads or 10 GΩ
0201	N/A	ALL
0402	< 0.012 μF	≥ 0.012 μF
0603	< 0.047 μF	≥ 0.047 μF
0805	< 0.047 μF	≥ 0.047 μF
1206	< 0.22 μF	≥ 0.22 μF
1210	< 0.39 μF	≥ 0.39 μF
1808	ALL	N/A
1812	< 2.2 μF	≥ 2.2 μF
1825	ALL	N/A
2220	< 10 μF	≥ 10 μF
2225	ALL	N/A

Table 2 – Chip Thickness/Packaging Quantities

Thickness Code	Case Size	Thickness ± Range (mm)	Paper Quantity		Plastic Quantity	
			7" Reel	13" Reel	7" Reel	13" Reel
CB	0603	0.80 ± 0.07	4,000	10,000	0	0
CF	0603	0.80 ± 0.07*	4,000	15,000	0	0
CD	0603	0.80 ± 0.15	4,000	10,000	0	0
DC	0805	0.78 ± 0.10	0	0	4,000	10,000
DD	0805	0.90 ± 0.10	0	0	4,000	10,000
DE	0805	1.00 ± 0.10	0	0	2,500	10,000
DG	0805	1.25 ± 0.15	0	0	2,500	10,000
DH	0805	1.25 ± 0.20	0	0	2,500	10,000
EB	1206	0.78 ± 0.10	4,000	10,000	4,000	10,000
EC	1206	0.90 ± 0.10	0	0	4,000	10,000
EN	1206	0.95 ± 0.10	0	0	4,000	10,000
ED	1206	1.00 ± 0.10	0	0	2,500	10,000
EE	1206	1.10 ± 0.10	0	0	2,500	10,000
EF	1206	1.20 ± 0.15	0	0	2,500	10,000
EM	1206	1.25 ± 0.15	0	0	2,500	10,000
EG	1206	1.60 ± 0.15	0	0	2,000	8,000
EH	1206	1.60 ± 0.20	0	0	2,000	8,000
FB	1210	0.78 ± 0.10	0	0	4,000	10,000
FC	1210	0.90 ± 0.10	0	0	4,000	10,000
FD	1210	0.95 ± 0.10	0	0	4,000	10,000
FE	1210	1.00 ± 0.10	0	0	2,500	10,000
FF	1210	1.10 ± 0.10	0	0	2,500	10,000
FG	1210	1.25 ± 0.15	0	0	2,500	10,000
FL	1210	1.40 ± 0.15	0	0	2,000	8,000
FH	1210	1.55 ± 0.15	0	0	2,000	8,000
FM	1210	1.70 ± 0.20	0	0	2,000	8,000
FJ	1210	1.85 ± 0.20	0	0	2,000	8,000
FK	1210	2.10 ± 0.20	0	0	2,000	8,000
FS	1210	2.50 ± 0.30	0	0	1,000	4,000
LD	1808	0.90 ± 0.10	0	0	2,500	10,000
GB	1812	1.00 ± 0.10	0	0	1,000	4,000
GC	1812	1.10 ± 0.10	0	0	1,000	4,000
GE	1812	1.30 ± 0.10	0	0	1,000	4,000
GF	1812	1.50 ± 0.10	0	0	1,000	4,000
GG	1812	1.55 ± 0.10	0	0	1,000	4,000
GK	1812	1.60 ± 0.20	0	0	1,000	4,000
GJ	1812	1.70 ± 0.15	0	0	1,000	4,000
HB	1825	1.10 ± 0.15	0	0	1,000	4,000
HC	1825	1.15 ± 0.15	0	0	1,000	4,000
HD	1825	1.30 ± 0.15	0	0	1,000	4,000
HF	1825	1.50 ± 0.15	0	0	1,000	4,000
JC	2220	1.10 ± 0.15	0	0	1,000	4,000
JD	2220	1.30 ± 0.15	0	0	1,000	4,000
JF	2220	1.50 ± 0.15	0	0	1,000	4,000
JO	2220	2.40 ± 0.15	0	0	500	2,000
KB	2225	1.00 ± 0.15	0	0	1,000	4,000
KC	2225	1.10 ± 0.15	0	0	1,000	4,000
KD	2225	1.30 ± 0.15	0	0	1,000	4,000
KE	2225	1.40 ± 0.15	0	0	1,000	4,000
Thickness Code	Case Size	Thickness ± Range (mm)	7" Reel	13" Reel	7" Reel	13" Reel
			Paper Quantity		Plastic Quantity	

Package quantity based on finished chip thickness specifications.

Table 3 – Chip Capacitor Land Pattern Design Recommendations per IPC–7351

EIA Size Code	Metric Size Code	Density Level A: Maximum (Most) Land Protrusion (mm)					Density Level B: Median (Nominal) Land Protrusion (mm)					Density Level C: Minimum (Least) Land Protrusion (mm)				
		C	Y	X	V1	V2	C	Y	X	V1	V2	C	Y	X	V1	V2
0603	1608	0.85	1.25	1.10	4.00	2.10	0.75	1.05	1.00	3.10	1.50	0.65	0.85	0.90	2.40	1.20
0805	2012	1.00	1.35	1.55	4.40	2.60	0.90	1.15	1.45	3.50	2.00	0.80	0.95	1.35	2.80	1.70
1206	3216	1.60	1.65	1.90	5.90	2.90	1.50	1.45	1.80	5.00	2.30	1.40	1.25	1.70	4.30	2.00
1210	3225	1.60	1.65	2.80	5.90	3.80	1.50	1.45	2.70	5.00	3.20	1.40	1.25	2.60	4.30	2.90
1808	4520	2.25	1.85	2.30	7.40	3.30	2.15	1.65	2.20	6.50	2.70	2.05	1.45	2.10	5.80	2.40
1812	4532	2.10	1.80	3.60	7.00	4.60	2.00	1.60	3.50	6.10	4.00	1.90	1.40	3.40	5.40	3.70
1825	4564	2.15	1.80	6.90	7.10	7.90	2.05	1.60	6.80	6.20	7.30	1.95	1.40	6.70	5.50	7.00
2220	5650	2.85	2.10	5.50	8.80	6.50	2.75	1.90	5.40	7.90	5.90	2.65	1.70	5.30	7.20	5.60
2225	5664	2.85	2.10	6.90	8.80	7.90	2.75	1.90	6.80	7.90	7.30	2.65	1.70	6.70	7.20	7.00

Density Level A: For low-density product applications. Recommended for wave solder applications and provides a wider process window for reflow solder processes. KEMET only recommends wave soldering of EIA 0603, 0805, and 1206 case sizes.

Density Level B: For products with a moderate level of component density. Provides a robust solder attachment condition for reflow solder processes.

Density Level C: For high component density product applications. Before adapting the minimum land pattern variations the user should perform qualification testing based on the conditions outlined in IPC Standard 7351 (IPC–7351).

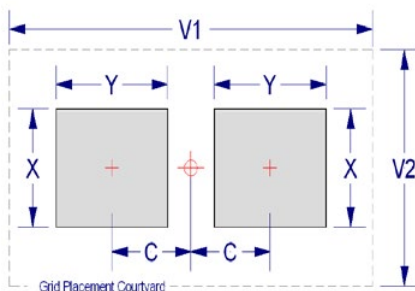

Soldering Process

Recommended Soldering Technique:

- Solder wave or solder reflow for EIA case sizes 0603, 0805, and 1206
- All other EIA case sizes are limited to solder reflow only

Recommended Soldering Profile:

- KEMET recommends following the guidelines outlined in IPC/JEDEC J–STD–020

Table 4 – Performance & Reliability: Test Methods and Conditions

Stress	Reference	Test or Inspection Method
Terminal Strength	JIS-C-6429	Appendix 1, Note: Force of 1.8 kg for 60 seconds.
Board Flex	JIS-C-6429	Appendix 2, Note: Standard termination system – 2.0 mm (minimum) for all except 3 mm for COG. Flexible termination system – 3.0 mm (minimum).
Solderability	J-STD-002	Magnification 50 X. Conditions:
		a) Method B, 4 hours @ 155°C, dry heat @ 235°C
		b) Method B @ 215°C category 3
		c) Method D, category 3 @ 260°C
Temperature Cycling	JESD22 Method JA-104	1,000 Cycles (-55°C to +125°C). Measurement at 24 hours +/- 2 hours after test conclusion.
Biased Humidity	MIL-STD-202 Method 103	Load Humidity: 1,000 hours 85°C/85% RH and rated voltage. Add 100 K ohm resistor. Measurement at 24 hours +/- 2 hours after test conclusion.
		Low Volt Humidity: 1,000 hours 85°C/85% RH and 1.5 V. Add 100 K ohm resistor. Measurement at 24 hours +/- 2 hours after test conclusion.
Moisture Resistance	MIL-STD-202 Method 106	t = 24 hours/cycle. Steps 7a and 7b not required. Unpowered. Measurement at 24 hours +/- 2 hours after test conclusion.
Thermal Shock	MIL-STD-202 Method 107	-55°C/+125°C. Note: Number of cycles required – 300, maximum transfer time – 20 seconds, dwell time – 15 minutes. Air – Air.
High Temperature Life	MIL-STD-202 Method 108 /EIA-198	1,000 hours at 125°C (85°C for X5R, Z5U and Y5V) with 2 X rated voltage applied.
Storage Life	MIL-STD-202 Method 108	150°C, 0 VDC for 1,000 hours.
Vibration	MIL-STD-202 Method 204	5 g's for 20 min., 12 cycles each of 3 orientations. Note: Use 8" X 5" PCB 0.031" thick 7 secure points on one long side and 2 secure points at corners of opposite sides. Parts mounted within 2" from any secure point. Test from 10 – 2,000 Hz
Mechanical Shock	MIL-STD-202 Method 213	Figure 1 of Method 213, Condition F.
Resistance to Solvents	MIL-STD-202 Method 215	Add aqueous wash chemical, OKEM Clean or equivalent.

Storage and Handling

Ceramic chip capacitors should be stored in normal working environments. While the chips themselves are quite robust in other environments, solderability will be degraded by exposure to high temperatures, high humidity, corrosive atmospheres, and long term storage. In addition, packaging materials will be degraded by high temperature– reels may soften or warp and tape peel force may increase. KEMET recommends that maximum storage temperature not exceed 40°C and maximum storage humidity not exceed 70% relative humidity. Temperature fluctuations should be minimized to avoid condensation on the parts and atmospheres should be free of chlorine and sulfur bearing compounds. For optimized solderability chip stock should be used promptly, preferably within 1.5 years of receipt.

Construction

Reference	Item	Material
A	Termination System	Finish
B		Barrier Layer
C		Epoxy Layer
D		Base Metal
E	Inner Electrode	Ni
F	Dielectric Material	BaTiO ₃

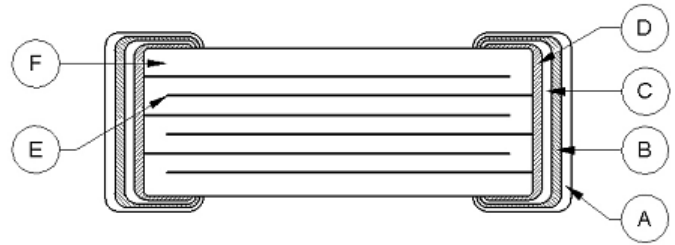

Note: Image is exaggerated in order to clearly identify all components of construction.

High Voltage with Flexible Termination System (HV FT-CAP)

X7R Dielectric, 500 – 3,000 VDC (Commercial & Automotive Grade)

Overview

KEMET's High Voltage with Flexible Termination (HV FT-CAP) surface mount MLCCs in X7R dielectric address the primary failure mode of MLCCs— flex cracks, which are typically the result of excessive tensile and shear stresses produced during board flexure and thermal cycling. Featuring several of the highest CV (capacitance/voltage) values available in the industry, these devices utilize a pliable and conductive silver epoxy between the base metal and nickel barrier layers of the termination system. The addition of this epoxy layer inhibits the transfer of board stress to the rigid ceramic body, therefore mitigating flex cracks which can result in low IR or short circuit failures. Although flexible termination technology does not eliminate the potential for mechanical damage that may propagate during extreme environmental and handling conditions, it does provide superior flex performance over standard termination systems.

The HV FT-CAP offers low leakage current, exhibits low ESR at high frequencies and finds conventional use as snubbers or filters in applications such as switching power supplies and lighting ballasts. Their exceptional performance at high frequencies has made them a preferred choice of design engineers worldwide. In addition to their use in power supplies, these capacitors are widely used in industries related to

automotive(hybrid), telecommunications, medical, military, aerospace, semiconductors and test/diagnostic equipment.

Combined with the stability of an X7R dielectric and designed to accommodate all capacitance requirements, these flex-robust devices are RoHS Compliant, offer up to 5 mm of flex-bend capability and exhibits a predictable change in capacitance with respect to time and voltage. Capacitance change with reference to ambient temperature is limited to $\pm 15\%$ from -55°C to $+125^{\circ}\text{C}$.

Automotive Grade is available for applications requiring proven, reliable performance in harsh environments. Whether under-hood or in-cabin, these capacitors are designed for mission and safety critical automotive circuits. Stricter testing protocol and inspection criteria have been established for automotive grade products in recognition of potentially harsh environmental conditions. KEMET automotive grade series capacitors meet the demanding Automotive Electronics Council's AEC-Q200 qualification requirements.

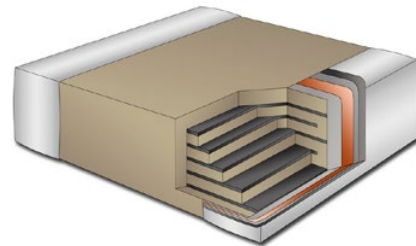

Ordering Information

C	1210	X	154	K	C	R	A	C	TU
Ceramic	Case Size (L" x W")	Specification/ Series	Capacitance Code (pF)	Capacitance Tolerance	Voltage	Dielectric	Failure Rate/ Design	Termination Finish ¹	Packaging/Grade (C-Spec) ²
	0805 1206 1210 1808 1812 1825 2220 2225	X = Flexible Termination	2 Significant Digits + Number of Zeros	J = $\pm 5\%$ K = $\pm 10\%$ M = $\pm 20\%$	C = 500 V B = 630 V D = 1,000 V F = 1,500 V G = 2,000 V Z = 2,500 V H = 3,000 V	R = X7R	A = N/A	C = 100% Matte Sn L = SnPb (5% min) C = 100% Matte Sn	Blank = Bulk TU = 7" Reel Unmarked TM = 7" Reel Marked AUTO = Automotive Grade 7" Reel Unmarked

¹ Additional termination finish options may be available. Contact KEMET for details.

^{1,2} SnPb termination finish option is not available on Automotive Grade product.

² Additional reeling or packaging options may be available. Contact KEMET for details.

Dimensions – Millimeters (Inches)

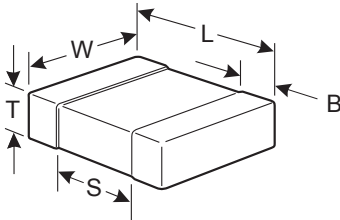

EIA Size Code	Metric Size Code	L Length	W Width	T Thickness	B Bandwidth	S Separation Minimum	Mounting Technique
0805	2012	2.00 (.079) ± 0.20 (.008)	1.25 (.049) ± 0.20 (.008)	See Table 2 for Thickness	0.50 (0.02) ± 0.25 (.010)	0.75 (.030)	Solder Wave or Solder Reflow
1206	3216	3.30 (.130) ± 0.40 (.016)	1.60 (.063) ± 0.20 (.008)		0.60 (.024) ± 0.25 (.010)	N/A	
1210	3225	3.30 (.130) ± 0.40 (.016)	2.50 (.098) ± 0.20 (.008)		0.60 (.024) ± 0.25 (.010)		
1808	4520	4.70 (.185) ± 0.50 (.020)	2.00 (.079) ± 0.20 (.008)		0.70 (.028) ± 0.35 (.014)		Solder Reflow Only
1812	4532	4.50 (.178) ± 0.40 (.016)	3.20 (.126) ± 0.30 (.012)		0.70 (.028) ± 0.35 (.014)		
1825	4564	4.60 (.181) ± 0.40 (.016)	6.40 (.252) ± 0.40 (.016)		0.70 (.028) ± 0.35 (.014)		
2220	5650	5.90 (.232) ± 0.75 (.030)	5.00 (.197) ± 0.40 (.016)		0.70 (.028) ± 0.35 (.014)		
2225	5664	5.90 (.232) ± 0.75 (.030)	6.40 (.248) ± 0.40 (.016)		0.70 (.028) ± 0.35 (.014)		

Benefits

- -55°C to +125°C operating temperature range
- Industry-leading CV values
- Superior flex performance (up to 5 mm)
- Exceptional performance at high frequencies
- Pb-Free and RoHS Compliant
- EIA 0805, 1206, 1210, 1808, 1812, 1825, 2220, and 2225 case sizes
- DC voltage ratings of 500 V, 630 V, 1 KV, 1.5 KV, 2 KV, 2.5 KV, and 3 KV
- Capacitance offerings ranging from 130 pF to 0.33 µF
- Available capacitance tolerances of ±5%, ±10% or ±20%
- Low ESR and ESL
- Non-polar device, minimizing installation concerns
- Commercial and Automotive (AEC-Q200) Grades available
- 100% pure matte tin-plated termination finish allowing for excellent solderability
- SnPb plated termination finish option available upon request (5% minimum)

Applications

Typical applications include switch mode power supplies (input filters, resonators, tank circuits, snubber circuits, output filters), high voltage coupling and DC blocking, lighting ballasts, voltage multiplier circuits, DC/DC converters and coupling capacitors in Ćuk converters. Markets include power supply, LCD fluorescent backlight ballasts, HID lighting, telecom equipment, industrial and medical equipment/control, LAN/WAN interface, analog and digital modems, and automotive (electric and hybrid vehicles, charging stations and lighting) applications.

Application Note

X7R dielectric is not recommended for AC line filtering or pulse applications. These capacitors and/or the assembled circuit board containing these capacitors may require a protective surface coating to prevent external surface arcing.

Qualification/Certification

Commercial Grade products are subject to internal qualification. Details regarding test methods and conditions are referenced in Table 4, Performance & Reliability.

Automotive Grade products meet or exceed the requirements outlined by the Automotive Electronics Council. Details regarding test methods and conditions are referenced in document AEC-Q200, Stress Test Qualification for Passive Components. For additional information regarding the Automotive Electronics Council and AEC-Q200, please visit their website at www.aecouncil.com.

Environmental Compliance

Pb-Free and RoHS Compliant (excluding SnPb termination finish option).



RoHS Compliant

Electrical Parameters/Characteristics

Item	Parameters/Characteristics
Operating Temperature Range	-55°C to +125°C
Capacitance Change with Reference to +25°C and 0 VDC Applied (TCC)	±15%
Aging Rate (Maximum % Capacitance Loss/Decade Hour)	3.0%
Dielectric Withstanding Voltage	150% of rated voltage for voltage rating of < 1,000 V 120% of rated voltage for voltage rating of ≥ 1,000 V (5 ±1 seconds and charge/discharge not exceeding 50 mA)
Dissipation Factor (DF) Maximum Limit @ 25°C	2.5%
Insulation Resistance (IR) Limit @ 25°C	See Insulation Resistance Limit Table (500 VDC applied for 120 ±5 seconds @ 25°C)

Regarding aging rate: Capacitance measurements (including tolerance) are indexed to a referee time of 1,000 hours.

To obtain IR limit, divide MΩ-μF value by the capacitance and compare to GΩ limit. Select the lower of the two limits.

Capacitance and dissipation factor (DF) measured under the following conditions:

1 kHz ± 50 Hz and 1.0 ±0.2 Vrms if capacitance ≤ 10 μF

120 Hz ± 10 Hz and 0.5 ±0.1 Vrms if capacitance > 10 μF

Note: When measuring capacitance it is important to ensure the set voltage level is held constant. The HP4284 and Agilent E4980 have a feature known as Automatic Level Control (ALC). The ALC feature should be switched to "ON."

Post Environmental Limits

High Temperature Life, Biased Humidity, Moisture Resistance					
Dielectric	Rated DC Voltage	Capacitance Value	Dissipation Factor (%)	Capacitance Shift	Insulation Resistance
X7R	> 25	All	3.0	±20%	10% of Initial Limit
	16/25		5.0		
	< 16		7.5		

Insulation Resistance Limit Table (X7R Dielectric)

EIA Case Size	1,000 Megohm Microfarads or 100 GΩ	100 Megohm Microfarads or 10 GΩ
0805	< 0.0039 μF	≥ 0.0039 μF
1206	< 0.012 μF	≥ 0.012 μF
1210	< 0.033 μF	≥ 0.033 μF
1808	< 0.018 μF	≥ 0.018 μF
1812	< 0.027 μF	≥ 0.027 μF
≥ 1825	All	All

Table 2 – Chip Thickness/Packaging Quantities

Thickness Code	Case Size	Thickness ± Range (mm)	Paper Quantity		Plastic Quantity	
			7" Reel	13" Reel	7" Reel	13" Reel
DG	0805	1.25 ± 0.15	0	0	2,500	10,000
EF	1206	1.20 ± 0.15	0	0	2,500	10,000
EG	1206	1.60 ± 0.15	0	0	2,000	8,000
EJ	1206	1.70 ± 0.20	0	0	2,000	8,000
FG	1210	1.25 ± 0.15	0	0	2,500	10,000
FL	1210	1.40 ± 0.15	0	0	2,000	8,000
FH	1210	1.55 ± 0.15	0	0	2,000	8,000
FM	1210	1.70 ± 0.20	0	0	2,000	8,000
FK	1210	2.10 ± 0.20	0	0	2,000	8,000
FS	1210	2.50 ± 0.30	0	0	1,000	4,000
LE	1808	1.00 ± 0.10	0	0	2,500	10,000
LA	1808	1.40 ± 0.15	0	0	1,000	4,000
LB	1808	1.60 ± 0.15	0	0	1,000	4,000
LC	1808	2.00 ± 0.15	0	0	1,000	4,000
GB	1812	1.00 ± 0.10	0	0	1,000	4,000
GC	1812	1.10 ± 0.10	0	0	1,000	4,000
GE	1812	1.30 ± 0.10	0	0	1,000	4,000
GG	1812	1.55 ± 0.10	0	0	1,000	4,000
GH	1812	1.40 ± 0.15	0	0	1,000	4,000
GF	1812	1.50 ± 0.10	0	0	1,000	4,000
GK	1812	1.60 ± 0.20	0	0	1,000	4,000
GJ	1812	1.70 ± 0.15	0	0	1,000	4,000
GN	1812	1.70 ± 0.20	0	0	1,000	4,000
GL	1812	1.90 ± 0.20	0	0	500	2,000
GM	1812	2.00 ± 0.20	0	0	500	2,000
GS	1812	2.10 ± 0.20	0	0	500	2,000
GO	1812	2.50 ± 0.20	0	0	500	2,000
HE	1825	1.40 ± 0.15	0	0	1,000	4,000
HG	1825	1.60 ± 0.20	0	0	1,000	4,000
HJ	1825	2.00 ± 0.20	0	0	500	2,000
HK	1825	2.50 ± 0.20	0	0	500	2,000
JE	2220	1.40 ± 0.15	0	0	1,000	4,000
JK	2220	1.60 ± 0.20	0	0	500	2,000
JL	2220	2.00 ± 0.20	0	0	500	2,000
JN	2220	2.50 ± 0.20	0	0	500	2,000
KE	2225	1.40 ± 0.15	0	0	1,000	4,000
KF	2225	1.60 ± 0.20	0	0	1,000	4,000
KH	2225	2.00 ± 0.20	0	0	500	2,000
KJ	2225	2.50 ± 0.20	0	0	500	2,000
Thickness Code	Case Size	Thickness ± Range (mm)	7" Reel	13" Reel	7" Reel	13" Reel
			Paper Quantity		Plastic Quantity	

Package quantity based on finished chip thickness specifications.

Table 3 – Chip Capacitor Land Pattern Design Recommendations per IPC–7351

EIA Size Code	Metric Size Code	Density Level A: Maximum (Most) Land Protrusion (mm)					Density Level B: Median (Nominal) Land Protrusion (mm)					Density Level C: Minimum (Least) Land Protrusion (mm)				
		C	Y	X	V1	V2	C	Y	X	V1	V2	C	Y	X	V1	V2
0805	2012	1.00	1.35	1.55	4.40	2.60	0.90	1.15	1.45	3.50	2.00	0.80	0.95	1.35	2.80	1.70
1206	3216	1.60	1.65	1.90	5.90	2.90	1.50	1.45	1.80	5.00	2.30	1.40	1.25	1.70	4.30	2.00
1210	3225	1.60	1.65	2.80	5.90	3.80	1.50	1.45	2.70	5.00	3.20	1.40	1.25	2.60	4.30	2.90
1808	4520	2.25	1.85	2.30	7.40	3.30	2.15	1.65	2.20	6.50	2.70	2.05	1.45	2.10	5.80	2.40
1812	4532	2.10	1.80	3.60	7.00	4.60	2.00	1.60	3.50	6.10	4.00	1.90	1.40	3.40	5.40	3.70
1825	4564	2.15	1.80	6.90	7.10	7.90	2.05	1.60	6.80	6.20	7.30	1.95	1.40	6.70	5.50	7.00
2220	5650	2.85	2.10	5.50	8.80	6.50	2.75	1.90	5.40	7.90	5.90	2.65	1.70	5.30	7.20	5.60
2225	5664	2.85	2.10	6.90	8.80	7.90	2.75	1.90	6.80	7.90	7.30	2.65	1.70	6.70	7.20	7.00

Density Level A: For low-density product applications. Recommended for wave solder applications and provides a wider process window for reflow solder processes. KEMET only recommends wave soldering of EIA 0603, 0805 and 1206 case sizes.

Density Level B: For products with a moderate level of component density. Provides a robust solder attachment condition for reflow solder processes.

Density Level C: For high component density product applications. Before adapting the minimum land pattern variations the user should perform qualification testing based on the conditions outlined in IPC Standard 7351 (IPC–7351).

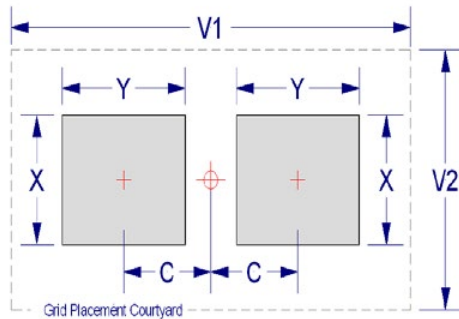

Soldering Process

Recommended Soldering Technique:

- Solder wave or solder reflow for EIA case sizes 0603, 0805 and 1206
- All other EIA case sizes are limited to solder reflow only

Recommended Soldering Profile:

- KEMET recommends following the guidelines outlined in IPC/JEDEC J–STD–020

Table 4 – Performance & Reliability: Test Methods and Conditions

Stress	Reference	Test or Inspection Method
Terminal Strength	JIS-C-6429	Appendix 1, Note: Force of 1.8 kg for 60 seconds.
Board Flex	JIS-C-6429	Appendix 2, Note: Standard termination system – 2.0 mm (minimum) for all except 3 mm for COG. Flexible termination system – 3.0 mm (minimum).
Solderability	J-STD-002	Magnification 50 X. Conditions:
		a) Method B, 4 hours @ 155°C, dry heat @ 235°C
		b) Method B @ 215°C category 3
		c) Method D, category 3 @ 260°C
Temperature Cycling	JESD22 Method JA-104	1,000 cycles (-55°C to +125°C). Measurement at 24 hours +/- 2 hours after test conclusion.
Biased Humidity	MIL-STD-202 Method 103	Load Humidity: 1,000 hours 85°C/85% RH and 200 VDC maximum. Add 100 K ohm resistor. Measurement at 24 hours +/- 2 hours after test conclusion.
		Low Volt Humidity: 1,000 hours 85°C/85% RH and 1.5 V. Add 100 K ohm resistor. Measurement at 24 hours +/- 2 hours after test conclusion.
Moisture Resistance	MIL-STD-202 Method 106	t = 24 hours/cycle. Steps 7a and 7b not required. Unpowered. Measurement at 24 hours +/- 2 hours after test conclusion.
Thermal Shock	MIL-STD-202 Method 107	-55°C/+125°C. Note: Number of cycles required – 300. Maximum transfer time – 20 seconds. Dwell time – 15 minutes. Air – Air.
High Temperature Life	MIL-STD-202 Method 108	1,000 hours at 125°C (85°C for X5R, Z5U and Y5V) with 1.2 X rated voltage applied.
Storage Life	MIL-STD-202 Method 108	150°C, 0 VDC for 1,000 hours.
Vibration	MIL-STD-202 Method 204	5 g's for 20 min., 12 cycles each of 3 orientations. Note: Use 8" X 5" PCB 0.031" thick 7 secure points on one long side and 2 secure points at corners of opposite sides. Parts mounted within 2" from any secure point. Test from 10 – 2,000 Hz
Mechanical Shock	MIL-STD-202 Method 213	Figure 1 of Method 213, Condition F.
Resistance to Solvents	MIL-STD-202 Method 215	Add aqueous wash chemical, OKEM Clean or equivalent.

Storage and Handling

Ceramic chip capacitors should be stored in normal working environments. While the chips themselves are quite robust in other environments, solderability will be degraded by exposure to high temperatures, high humidity, corrosive atmospheres, and long term storage. In addition, packaging materials will be degraded by high temperature– reels may soften or warp and tape peel force may increase. KEMET recommends that maximum storage temperature not exceed 40°C and maximum storage humidity not exceed 70% relative humidity. Temperature fluctuations should be minimized to avoid condensation on the parts and atmospheres should be free of chlorine and sulfur bearing compounds. For optimized solderability chip stock should be used promptly, preferably within 1.5 years of receipt.

Construction

Reference	Item	Material
A	Termination System	Finish
B		Barrier Layer
C		Epoxy Layer
D		Base Metal
E	Inner Electrode	Ni
F	Dielectric Material	BaTiO ₃

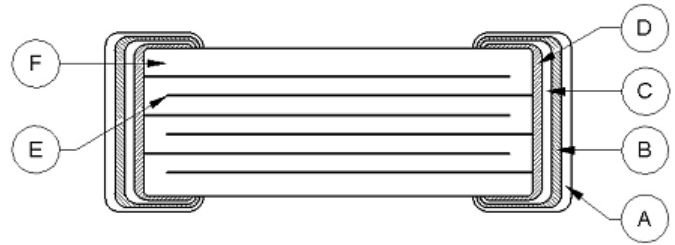

Note: Image is exaggerated in order to clearly identify all components of construction.

Flexible Termination System (FT-CAP), Ultra-Stable X8R Dielectric, 25 – 100 VDC (Commercial & Automotive Grade)

Overview

KEMET's Flexible Termination (FT-CAP) Multilayer Ceramic Capacitor in Ultra-Stable X8R dielectric incorporates a unique, flexible termination system that is integrated with KEMET's standard termination materials. A conductive silver epoxy is utilized between the base metal and nickel barrier layers of KEMET's standard termination system in order to establish pliability while maintaining terminal strength, solderability and electrical performance. This technology was developed in order to address the primary failure mode of MLCCs— flex cracks, which are typically the result of excessive tensile and shear stresses produced during board flexure and thermal cycling. Flexible termination technology inhibits the transfer of board stress to the rigid ceramic body, therefore mitigating flex cracks which can result in low IR or short circuit failures.

Although this technology does not eliminate the potential for mechanical damage that may propagate during extreme environmental and handling conditions, it does provide superior flex performance over standard termination systems. FT-CAP complements KEMET's Open Mode, Floating Electrode (FE-

CAP), Floating Electrode with Flexible Termination (FF-CAP), and KEMET Power Solutions (KPS) product lines by providing a complete portfolio of flex mitigation solutions.

Combined with the stability of KEMET's Ultra-Stable high temperature dielectric technology, these flex-robust devices are RoHS Compliant, offer up to 5 mm of flex-bend capability and feature a 150°C maximum operating temperature. Ultra-Stable X8R dielectric offers the same temperature capability as conventional X8R but without the capacitance loss due to applied DC voltage. These devices exhibit no change in capacitance with respect to voltage and boast a minimal change in capacitance with reference to ambient temperature. They are also suitable replacements for higher capacitance and larger footprint devices that fail to offer capacitance stability. Capacitance change with respect to temperature is limited to $\pm 15\%$ from -55°C to +150°C.

In addition to Commercial Grade, Automotive Grade devices are available which meet the demanding Automotive Electronics Council's AEC-Q200 qualification requirements.

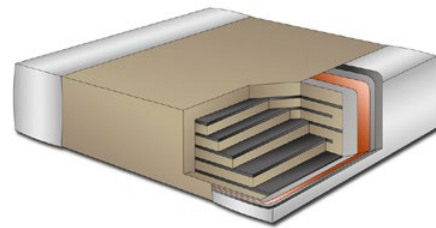

Ordering Information

C	1206	X	104	J	3	H	A	C	AUTO
Ceramic	Case Size (L" x W")	Specification/ Series	Capacitance Code (pF)	Capacitance Tolerance	Voltage	Dielectric	Failure Rate/ Design	Termination Finish ¹	Packaging/Grade (C-Spec) ²
	0603 0805 1206 1210 1812	X = Flexible Termination	2 significant digits + number of zeros.	F = $\pm 1\%$ G = $\pm 2\%$ J = $\pm 5\%$ K = $\pm 10\%$ M = $\pm 20\%$	3 = 25 V 5 = 50 V 1 = 100 V	H = Ultra-Stable X8R	A = N/A	C = 100% Matte Sn L = SnPb (5% minimum)	Blank = Bulk TU = 7" Reel Unmarked AUTO = Automotive Grade 7" Reel Unmarked

¹ Additional termination finish options may be available. Contact KEMET for details.

^{1,2} SnPb termination finish option is not available on Automotive Grade product.

² Additional reeling or packaging options may be available. Contact KEMET for details.

Dimensions – Millimeters (Inches)

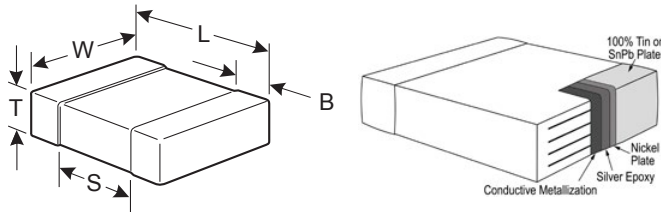

EIA Size Code	Metric Size Code	L Length	W Width	T Thickness	B Bandwidth	S Separation Minimum	Mounting Technique
0603	1608	1.60 (.064) ± 0.17 (.007)	0.80 (.032) ± 0.15 (.006)	See Table 2 for Thickness	0.45 (.018) ± 0.15 (.006)	0.58 (.023)	Solder Wave or Solder Reflow
0805	2012	2.00 (.079) ± 0.20 (.008)	1.25 (.049) ± 0.20 (.008)		0.50 (0.02) ± 0.25 (.010)	0.75 (.030)	
1206	3216	3.30 (.130) ± 0.40 (.016)	1.60 (.063) ± 0.20 (.008)		0.60 (.024) ± 0.25 (.010)	N/A	Solder Reflow Only
1210	3225	3.30 (.130) ± 0.40 (.016)	2.50 (.098) ± 0.20 (.008)		0.60 (.024) ± 0.25 (.010)		
1812	4532	4.50 (.178) ± 0.40 (.016)	3.20 (.126) ± 0.30 (.012)		0.70 (.028) ± 0.35 (.014)		

Benefits

- -55°C to +150°C operating temperature range
- Superior flex performance (up to 5 mm)
- Pb-Free and RoHS Compliant
- EIA 0603, 0805, 1206, 1210, and 1812 case sizes
- DC voltage ratings of 25 V, 50 V, and 100 V
- Capacitance offerings ranging from 430 pF to 0.22 µF
- Available capacitance tolerances of ±1%, ±2%, ±5%, ±10%, and ±20%
- Extremely low ESR and ESL
- High thermal stability
- High ripple current capability
- No capacitance change with respect to applied rated DC voltage
- Non-polar device, minimizing installation concerns
- Commercial & Automotive (AEC-Q200) Grades available
- 100% pure matte tin-plated termination finish allowing for excellent solderability
- SnPb plated termination finish option available upon request (5% minimum)

Applications

Typical applications include decoupling, bypass, filtering and transient voltage suppression in critical and safety relevant circuits without (integrated) current limitation including those subject to high levels of board flexure or temperature cycling.

Qualification/Certification

Commercial Grade products are subject to internal qualification. Details regarding test methods and conditions are referenced in Table 4, Performance & Reliability.

Automotive Grade products meet or exceed the requirements outlined by the Automotive Electronics Council. Details regarding test methods and conditions are referenced in document AEC-Q200, Stress Test Qualification for Passive Components. For additional information regarding the Automotive Electronics Council and AEC-Q200, please visit their website at www.aecouncil.com.

Environmental Compliance

Pb-Free and RoHS Compliant (excluding SnPb termination finish option)



RoHS Compliant

Electrical Parameters/Characteristics

Item	Parameters/Characteristics
Operating Temperature Range	-55°C to +150°C
Capacitance Change with Reference to +25°C and 0 VDC Applied (TCC)	±15%
Aging Rate (Maximum % Capacitance Loss/Decade Hour)	0%
Dielectric Withstanding Voltage (DWV)	250% of rated voltage (5 ±1 seconds and charge/discharge not exceeding 50 mA)
Dissipation Factor (DF) Maximum Limit @ 25°C	2.5%
Insulation Resistance (IR) Limit @ 25°C	1,000 megohm microfarads or 100 GΩ (Rated voltage applied for 120 ±5 seconds @ 25°C)

To obtain IR limit, divide MΩ-μF value by the capacitance and compare to GΩ limit. Select the lower of the two limits.

Capacitance and dissipation factor (DF) measured under the following conditions:

1 MHz ±100 kHz and 1.0 ±0.2 Vrms if capacitance ≤ 1,000 pF

1 kHz ±50 Hz and 1.0 ±0.2 Vrms if capacitance > 1,000 pF

Note: When measuring capacitance it is important to ensure the set voltage level is held constant. The HP4284 and Agilent E4980 have a feature known as Automatic Level Control (ALC). The ALC feature should be switched to "ON."

Post Environmental Limits

High Temperature Life, Biased Humidity, Moisture Resistance					
Dielectric	Rated DC Voltage	Capacitance Value	Dissipation Factor (Maximum %)	Capacitance Shift	Insulation Resistance
Ultra-Stable X8R	All	All	2.5	0.3% or ±0.25 pF	10% of Initial Limit

Table 1A – Capacitance Range/Selection Waterfall (0603 – 1812 Case Sizes)

Capacitance	Capacitance Code	Case Size / Series					C0603C			C0805C			C1206C			C1210C			C1812C	
		Voltage Code					3	5	1	3	5	1	3	5	1	3	5	1	5	1
		Rated Voltage (VDC)					25	50	100	25	50	100	25	50	100	25	50	100	50	100
		Capacitance Tolerance					Product Availability and Chip Thickness Codes See Table 2 for Chip Thickness Dimensions													
430 pF	431	F	G	J	K	M	CB	CB	CB											
470 pF	471	F	G	J	K	M	CB	CB	CB											
510 pF	511	F	G	J	K	M	CB	CB	CB											
560 pF	561	F	G	J	K	M	CB	CB	CB											
620 pF	621	F	G	J	K	M	CB	CB	CB											
680 pF	681	F	G	J	K	M	CB	CB	CB											
750 pF	751	F	G	J	K	M	CB	CB	CB											
820 pF	821	F	G	J	K	M	CB	CB	CB											
910 pF	911	F	G	J	K	M	CB	CB	CB											
1,000 pF	102	F	G	J	K	M	CB	CB	CB											
1,100 pF	112	F	G	J	K	M	CB	CB	CB											
1,200 pF	122	F	G	J	K	M	CB	CB	CB											
1,300 pF	132	F	G	J	K	M	CB	CB	CB											
1,500 pF	152	F	G	J	K	M	CB	CB	CB											
1,600 pF	162	F	G	J	K	M	CB	CB	CB											
1,800 pF	182	F	G	J	K	M	CB	CB	CB											
2,000 pF	202	F	G	J	K	M	CB	CB	CB	DC	DC	DC								
2,200 pF	222	F	G	J	K	M	CB	CB	CB	DC	DC	DC								
2,400 pF	242	F	G	J	K	M	CB	CB	CB	DC	DC	DC								
2,700 pF	272	F	G	J	K	M	CB	CB	CB	DC	DC	DC								
3,000 pF	302	F	G	J	K	M	CB	CB	CB	DC	DC	DC								
3,300 pF	332	F	G	J	K	M	CB	CB	CB	DC	DC	DC								
3,600 pF	362	F	G	J	K	M	CB	CB	CB	DC	DC	DC								
3,900 pF	392	F	G	J	K	M	CB	CB	CB	DC	DC	DC								
4,300 pF	432	F	G	J	K	M	CB	CB	CB	DC	DC	DC								
4,700 pF	472	F	G	J	K	M	CB	CB	CB	DC	DC	DC								
5,100 pF	512	F	G	J	K	M	CB	CB	CB	DC	DC	DC								
5,600 pF	562	F	G	J	K	M	CB	CB	CB	DC	DC	DC								
6,200 pF	622	F	G	J	K	M	CB	CB	CB	DC	DC	DC								
6,800 pF	682	F	G	J	K	M	CB	CB	CB	DC	DC	DC	EB	EB	EB					
7,500 pF	752	F	G	J	K	M	CB	CB	CB	DC	DC	DC	EB	EB	EB					
8,200 pF	822	F	G	J	K	M	CB	CB	CB	DC	DC	DC	EB	EB	EB					
9,100 pF	912	F	G	J	K	M	CB	CB	CB	DC	DC	DC	EB	EB	EB					
10,000 pF	103	F	G	J	K	M	CB	CB	CB	DC	DC	DD	EB	EB	EB					
12,000 pF	123	F	G	J	K	M	CB	CB	CB	DC	DC	DE	EB	EB	EB	FB	FB	FB		
15,000 pF	153	F	G	J	K	M	CB	CB	CB	DC	DD	DG	EB	EB	EB	FB	FB	FB	GB	GB
18,000 pF	183	F	G	J	K	M	CB	CB	CB	DC	DD		EB	EB	EB	FB	FB	FB	GB	GB
22,000 pF	223	F	G	J	K	M	CB	CB	CB	DD	DF		EB	EB	EC	FB	FB	FB	GB	GB
27,000 pF	273	F	G	J	K	M	CB	CB	CB	DF			EB	EB	EE	FB	FB	FB	GB	GB
33,000 pF	333	F	G	J	K	M	CB	CB	CB	DG			EB	EB	EE	FB	FB	FB	GB	GB
47,000 pF	473	F	G	J	K	M	CB	CB	CB				EC	EE	EH	FB	FB	FE	GB	GB
56,000 pF	563	F	G	J	K	M	CB	CB	CB				ED	EF	EH	FB	FB	FF	GB	GB
68,000 pF	683	F	G	J	K	M	CB	CB	CB				EF	EH		FB	FC	FG	GB	GB
82,000 pF	823	F	G	J	K	M	CB	CB	CB				EH	EH		FC	FF	FH	GB	GB
100,000 pF	104	F	G	J	K	M	CB	CB	CB				EH			FE	FG	FM	GB	GD
120,000 pF	124	F	G	J	K	M	CB	CB	CB							FG	FH		GB	GH
150,000 pF	154	F	G	J	K	M	CB	CB	CB							FH	FM		GD	GN
180,000 pF	184	F	G	J	K	M	CB	CB	CB							FJ			GH	
220,000 pF	224	F	G	J	K	M	CB	CB	CB										GK	
Capacitance	Capacitance Code	Rated Voltage (VDC)					25	50	100	25	50	100	25	50	100	25	50	100	50	100
		Voltage Code					3	5	1	3	5	1	3	5	1	3	5	1	5	1
		Case Size / Series					C0603C			C0805C			C1206C			C1210C			C1812C	

Table 2 – Chip Thickness/Packaging Quantities

Thickness Code	Case Size	Thickness ± Range (mm)	Paper Quantity		Plastic Quantity	
			7" Reel	13" Reel	7" Reel	13" Reel
CB	0603	0.80 ± 0.07	4,000	10,000	0	0
DC	0805	0.78 ± 0.10	0	0	4,000	10,000
DD	0805	0.90 ± 0.10	0	0	4,000	10,000
DE	0805	1.00 ± 0.10	0	0	2,500	10,000
DF	0805	1.10 ± 0.10	0	0	2,500	10,000
DG	0805	1.25 ± 0.15	0	0	2,500	10,000
EB	1206	0.78 ± 0.10	4,000	10,000	4,000	10,000
EC	1206	0.90 ± 0.10	0	0	4,000	10,000
ED	1206	1.00 ± 0.10	0	0	2,500	10,000
EE	1206	1.10 ± 0.10	0	0	2,500	10,000
EF	1206	1.20 ± 0.15	0	0	2,500	10,000
EH	1206	1.60 ± 0.20	0	0	2,000	8,000
FB	1210	0.78 ± 0.10	0	0	4,000	10,000
FC	1210	0.90 ± 0.10	0	0	4,000	10,000
FE	1210	1.00 ± 0.10	0	0	2,500	10,000
FF	1210	1.10 ± 0.10	0	0	2,500	10,000
FG	1210	1.25 ± 0.15	0	0	2,500	10,000
FH	1210	1.55 ± 0.15	0	0	2,000	8,000
FM	1210	1.70 ± 0.20	0	0	2,000	8,000
FJ	1210	1.85 ± 0.20	0	0	2,000	8,000
GB	1812	1.00 ± 0.10	0	0	1,000	4,000
GD	1812	1.25 ± 0.15	0	0	1,000	4,000
GH	1812	1.40 ± 0.15	0	0	1,000	4,000
GK	1812	1.60 ± 0.20	0	0	1,000	4,000
GN	1812	1.70 ± 0.20	0	0	1,000	4,000
Thickness Code	Case Size	Thickness ± Range (mm)	7" Reel	13" Reel	7" Reel	13" Reel
			Paper Quantity		Plastic Quantity	

Package quantity based on finished chip thickness specifications.

Table 3 – Chip Capacitor Land Pattern Design Recommendations per IPC–7351 (mm)

EIA Size Code	Metric Size Code	Density Level A: Maximum (Most) Land Protrusion (mm)					Density Level B: Median (Nominal) Land Protrusion (mm)					Density Level C: Minimum (Least) Land Protrusion (mm)				
		C	Y	X	V1	V2	C	Y	X	V1	V2	C	Y	X	V1	V2
0603	1608	0.85	1.25	1.10	4.00	2.10	0.75	1.05	1.00	3.10	1.50	0.65	0.85	0.90	2.40	1.20
0805	2012	1.00	1.35	1.55	4.40	2.60	0.90	1.15	1.45	3.50	2.00	0.80	0.95	1.35	2.80	1.70
1206	3216	1.60	1.65	1.90	5.90	2.90	1.50	1.45	1.80	5.00	2.30	1.40	1.25	1.70	4.30	2.00
1210	3225	1.60	1.65	2.80	5.90	3.80	1.50	1.45	2.70	5.00	3.20	1.40	1.25	2.60	4.30	2.90
1812	4532	2.10	1.80	3.60	7.00	4.60	2.00	1.60	3.50	6.10	4.00	1.90	1.40	3.40	5.40	3.70

Density Level A: For low-density product applications. Recommended for wave solder applications and provides a wider process window for reflow solder processes. KEMET only recommends wave soldering of EIA 0603, 0805, and 1206 case sizes.

Density Level B: For products with a moderate level of component density. Provides a robust solder attachment condition for reflow solder processes.

Density Level C: For high component density product applications. Before adapting the minimum land pattern variations the user should perform qualification testing based on the conditions outlined in IPC Standard 7351 (IPC–7351).

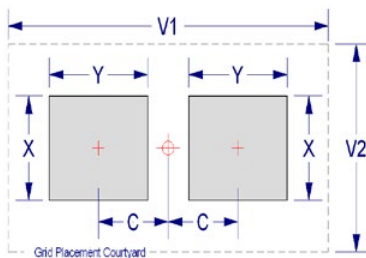

Soldering Process

Recommended Soldering Technique:

- Solder wave or solder reflow for EIA case sizes 0603, 0805, and 1206
- All other EIA case sizes are limited to solder reflow only

Recommended Soldering Profile:

- KEMET recommends following the guidelines outlined in IPC/JEDEC J–STD–020

Table 4 – Performance & Reliability: Test Methods and Conditions

Stress	Reference	Test or Inspection Method
Terminal Strength	JIS-C-6429	Appendix 1, Note: Force of 1.8 kg for 60 seconds.
Board Flex	JIS-C-6429	Appendix 2, Note: Standard termination system – 2.0 mm (minimum) for all except 3 mm for COG. Flexible termination system – 3.0 mm (minimum).
Solderability	J-STD-002	Magnification 50 X. Conditions:
		a) Method B, 4 hours @ 155°C, dry heat @ 235°C
		b) Method B @ 215°C category 3
		c) Method D, category 3 @ 260°C
Temperature Cycling	JESD22 Method JA-104	1,000 cycles (-55°C to +150°C). Measurement at 24 hours +/- 2 hours after test conclusion.
Biased Humidity	MIL-STD-202 Method 103	Load Humidity: 1,000 hours 85°C/85%RH and rated voltage. Add 100K ohm resistor. Measurement at 24 hours +/- 2 hours after test conclusion.
		Low Volt Humidity: 1,000 hours 85°C/85% RH and 1.5 V. Add 100 K ohm resistor. Measurement at 24 hours +/- 2 hours after test conclusion.
Moisture Resistance	MIL-STD-202 Method 106	t = 24 hours/cycle. Steps 7a and 7b not required. Unpowered. Measurement at 24 hours. +/- 2 hours after test conclusion.
Thermal Shock	MIL-STD-202 Method 107	-55°C/+150. Note: Number of cycles required – 300. Maximum transfer time – 20 seconds. Dwell time – 15 minutes. Air – Air.
High Temperature Life	MIL-STD-202 Method 108 /EIA-198	1,000 hours at 150°C with 2 X rated voltage applied.
Storage Life	MIL-STD-202 Method 108	150°C, 0 VDC for 1,000 hours.
Vibration	MIL-STD-202 Method 204	5 g's for 20 min., 12 cycles each of 3 orientations. Note: Use 8" X 5" PCB 0.031" thick 7 secure points on one long side and 2 secure points at corners of opposite sides. Parts mounted within 2" from any secure point. Test from 10 – 2,000 Hz
Mechanical Shock	MIL-STD-202 Method 213	Figure 1 of Method 213, Condition F.
Resistance to Solvents	MIL-STD-202 Method 215	Add aqueous wash chemical, OKEM Clean or equivalent.

Storage and Handling

Ceramic chip capacitors should be stored in normal working environments. While the chips themselves are quite robust in other environments, solderability will be degraded by exposure to high temperatures, high humidity, corrosive atmospheres, and long term storage. In addition, packaging materials will be degraded by high temperature– reels may soften or warp and tape peel force may increase. KEMET recommends that maximum storage temperature not exceed 40°C and maximum storage humidity not exceed 70% relative humidity. Temperature fluctuations should be minimized to avoid condensation on the parts and atmospheres should be free of chlorine and sulfur bearing compounds. For optimized solderability chip stock should be used promptly, preferably within 1.5 years of receipt.

Construction

Reference	Item	Material	
A	Termination System	Finish	100% Matte Sn
B		Barrier Layer	Ni
C		Epoxy Layer	Ag
D		Base Metal	Cu
E	Inner Electrode	Ni	
F	Dielectric Material	CaZrO ₃	

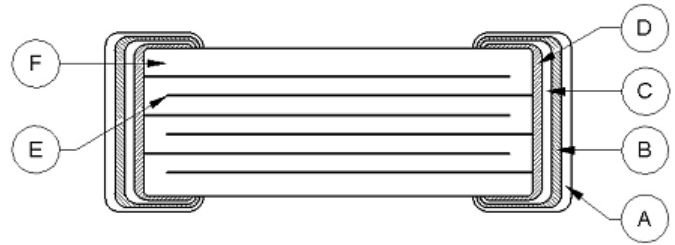

Note: Image is exaggerated in order to clearly identify all components of construction.

Capacitor Marking (Optional):

Laser marking option is not available on:

- COG, Ultra Stable X8R and Y5V dielectric devices
- EIA 0402 case size devices
- EIA 0603 case size devices with Flexible Termination option.
- KPS Commercial and Automotive grade stacked devices.

These capacitors are supplied unmarked only.

Floating Electrode Design with Flexible Termination System (FF-CAP), X7R Dielectric, 6.3 – 250 VDC (Commercial & Automotive Grade)

Overview

KEMET's Floating Electrode with Flexible Termination capacitor (FF-CAP) combines two existing KEMET technologies— Floating Electrode and Flexible Termination. The floating electrode component utilizes a cascading internal electrode design configured to form multiple capacitors in series within a single monolithic structure. This unique configuration results in enhanced voltage and ESD performance over standard capacitor designs while allowing for a fail-open condition if mechanically damaged (cracked). The flexible termination component utilizes a conductive silver epoxy between the base metal and nickel barrier layers of KEMET's standard termination system in order to establish pliability while maintaining terminal strength, solderability and electrical performance. Both technologies address the primary failure mode of MLCCs— flex cracks, which are typically the result of excessive tensile and shear stresses produced during board flexure and thermal cycling.

Although neither technology can eliminate the potential for mechanical damage that may propagate during extreme environmental and/or handling conditions, the combination of these two technologies provide the ultimate level of protection against a low IR or short circuit condition. The FF-CAP complements KEMET's Open Mode, Floating Electrode (FE-CAP), Flexible Termination (FT-CAP) and KEMET Power Solutions (KPS) product lines by providing an ultimate fail-safe design optimized for low to mid range capacitance values. These devices exhibit a predictable change in capacitance with respect to time and voltage and boast a minimal change in capacitance with reference to ambient temperature. Capacitance change is limited to $\pm 15\%$ from -55°C to $+125^{\circ}\text{C}$.

In addition to Commercial Grade, Automotive Grade devices are available which meet the demanding Automotive Electronics Council's AEC-Q200 qualification requirements.

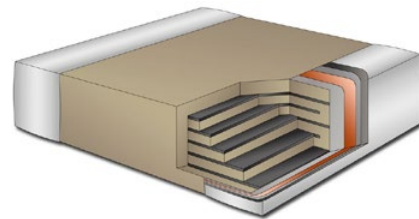

Ordering Information

C	0805	Y	104	K	5	R	A	C	TU
Ceramic	Case Size (L" x W")	Specification/ Series	Capacitance Code (pF)	Capacitance Tolerance	Voltage	Dielectric	Failure Rate/ Design	Termination Finish ¹	Packaging/Grade (C-Spec) ²
	0603 0805 1206 1210 1812	Y = Floating Electrode with Flexible Termination	2 Significant Digits + Number of Zeros	J = $\pm 5\%$ K = $\pm 10\%$ M = $\pm 20\%$	9 = 6.3 V 8 = 10 V 4 = 16 V 3 = 25 V 5 = 50 V 1 = 100 V 2 = 200 V A = 250 V	R = X7R	A = N/A	C = 100% Matte Sn L = SnPb (5% minimum)	Blank = Bulk TU = 7" Reel Unmarked TM = 7" Reel Marked

¹ Additional termination finish options may be available. Contact KEMET for details.

^{1,2} SnPb termination finish option is not available on automotive grade product.

² Additional reeling or packaging options may be available. Contact KEMET for details.

Dimensions – Millimeters (Inches)

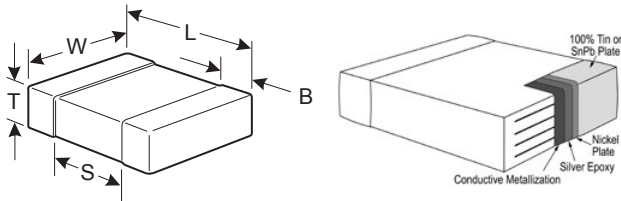

EIA Size Code	Metric Size Code	L Length	W Width	T Thickness	B Bandwidth	S Separation Minimum	Mounting Technique
0603	1608	1.60 (.064) ± 0.17 (.007)	0.80 (.032) ± 0.15 (.006)	See Table 2 for Thickness	0.45 (.018) ± 0.15 (.006)	0.58 (.023)	Solder Wave or Solder Reflow
0805	2012	2.00 (.079) ± 0.20 (.008)	1.25 (.049) ± 0.20 (.008)		0.50 (0.02) ± 0.25 (.010)	0.75 (.030)	
1206	3216	3.30 (.130) ± 0.40 (.016)	1.60 (.063) ± 0.20 (.008)		0.60 (.024) ± 0.25 (.010)	N/A	Solder Reflow Only
1210	3225	3.30 (.130) ± 0.40 (.016)	2.50 (.098) ± 0.20 (.008)		0.60 (.024) ± 0.25 (.010)		
1812	4532	4.50 (.178) ± 0.40 (.016)	3.20 (.126) ± 0.30 (.012)		0.70 (.028) ± 0.35 (.014)		

Benefits

- -55°C to +125°C operating temperature range
- Superior flex performance (up to 5 mm)
- Floating Electrode/fail open design
- Low to mid capacitance flex mitigation
- Pb-Free and RoHS Compliant
- EIA 0603, 0805, 1206, 1210, and 1812 case sizes
- DC voltage ratings of 6.3 V, 10 V, 16 V, 25 V, 50 V, 100 V, 200 V, and 250 V
- Capacitance offerings ranging from 180 pF to 0.22 µF
- Available capacitance tolerances of ±5%, ±10%, and ±20%
- Commercial & Automotive (AEC-Q200) grades available
- Non-polar device, minimizing installation concerns
- 100% pure matte tin-plated termination finish allowing for excellent solderability
- SnPb termination finish option available upon request (5% minimum)

Applications

Typical applications include circuits with a direct battery or power source connection, critical and safety relevant circuits without (integrated) current limitation and any application that is subject to high levels of board flexure or temperature cycling. Examples include raw power input side filtering (power plane/bus), high current applications (automobile battery line) and circuits that cannot be fused to open. Markets include consumer, medical, industrial (power supply), automotive, aerospace and telecom.

Qualification/Certification

Commercial Grade products are subject to internal qualification. Details regarding test methods and conditions are referenced in Table 4, Performance & Reliability.

Automotive Grade products meet or exceed the requirements outlined by the Automotive Electronics Council. Details regarding test methods and conditions are referenced in document AEC-Q200, Stress Test Qualification for Passive Components. For additional information regarding the Automotive Electronics Council and AEC-Q200, please visit their website at www.aecouncil.com.

Environmental Compliance

Pb-Free and RoHS Compliant (excluding SnPb termination finish option).



RoHS Compliant

Electrical Parameters/Characteristics

Item	Parameters/Characteristics
Operating Temperature Range	-55°C to +125°C
Capacitance Change with Reference to +25°C and 0 VDC Applied (TCC)	±15%
Aging Rate (Maximum % Capacitance Loss/Decade Hour)	3.0%
Dielectric Withstanding Voltage	250% of rated voltage (5 ±1 seconds and charge/discharge not exceeding 50 mA)
Dissipation Factor (DF) Maximum Limit @ 25°C	5% (6.3 and 10 V), 3.5% (16 and 25 V) and 2.5% (50 to 250 V)
Insulation Resistance (IR) Limit @ 25°C	See Insulation Resistance Limit Table (Rated voltage applied for 120 ±5 seconds @ 25°C)

Regarding aging rate: Capacitance measurements (including tolerance) are indexed to a referee time of 1,000 hours.

To obtain IR limit, divide $M\Omega \cdot \mu F$ value by the capacitance and compare to $G\Omega$ limit. Select the lower of the two limits.

Capacitance and dissipation factor (DF) measured under the following conditions:

1 kHz ±50 Hz and 1.0 ±0.2 Vrms if capacitance ≤ 10 μF

120 Hz ±10 Hz and 0.5 ±0.1 Vrms if capacitance > 10 μF

Note: When measuring capacitance it is important to ensure the set voltage level is held constant. The HP4284 and Agilent E4980 have a feature known as Automatic Level Control (ALC). The ALC feature should be switched to "ON."

Post Environmental Limits

High Temperature Life, Biased Humidity, Moisture Resistance					
Dielectric	Rated DC Voltage	Capacitance Value	Dissipation Factor (Maximum %)	Capacitance Shift	Insulation Resistance
X7R	> 25	All	3.0	±20%	10% of Initial Limit
	16/25		5.0		
	< 16		7.5		

Insulation Resistance Limit Table (X7R Dielectric)

EIA Case Size	1,000 Megohm Microfarads or 100 GΩ	500 Megohm Microfarads or 10 GΩ
0201	N/A	ALL
0402	< 0.012 μF	≥ 0.012 μF
0603	< 0.047 μF	≥ 0.047 μF
0805	< 0.047 μF	≥ 0.047 μF
1206	< 0.22 μF	≥ 0.22 μF
1210	< 0.39 μF	≥ 0.39 μF
1808	ALL	N/A
1812	< 2.2 μF	≥ 2.2 μF
1825	ALL	N/A
2220	< 10 μF	≥ 10 μF
2225	ALL	N/A

Table 1A – Capacitance Range/Selection Waterfall (0603 – 0805 Case Sizes)

Capacitance	Cap Code	Case Size / Series			C0603Y								C0805Y							
		Voltage Code			9	8	4	3	5	1	2	9	8	4	3	5	1	2	A	
		Rated Voltage (VDC)			6.3	10	16	25	50	100	200	6.3	10	16	25	50	100	200	250	
		Capacitance Tolerance			Product Availability and Chip Thickness Codes See Table 2 for Chip Thickness Dimensions															
180 pF	181	J	K	M	CB	CB	CB	CB	CB	CB	CB	DC	DC	DC	DC	DC	DC	DC	DC	
220 pF	221	J	K	M	CB	CB	CB	CB	CB	CB	CB	DC	DC	DC	DC	DC	DC	DC	DC	
270 pF	271	J	K	M	CB	CB	CB	CB	CB	CB	CB	DC	DC	DC	DC	DC	DC	DC	DC	
330 pF	331	J	K	M	CB	CB	CB	CB	CB	CB	CB	DC	DC	DC	DC	DC	DC	DC	DC	
390 pF	391	J	K	M	CB	CB	CB	CB	CB	CB	CB	DC	DC	DC	DC	DC	DC	DC	DC	
470 pF	471	J	K	M	CB	CB	CB	CB	CB	CB	CB	DC	DC	DC	DC	DC	DC	DC	DC	
560 pF	561	J	K	M	CB	CB	CB	CB	CB	CB	CB	DC	DC	DC	DC	DC	DC	DC	DC	
680 pF	681	J	K	M	CB	CB	CB	CB	CB	CB	CB	DC	DC	DC	DC	DC	DC	DC	DC	
820 pF	821	J	K	M	CB	CB	CB	CB	CB	CB	CB	DC	DC	DC	DC	DC	DC	DC	DC	
1,000 pF	102	J	K	M	CB	CB	CB	CB	CB	CF	CB	DC	DC	DC	DC	DC	DC	DC	DC	
1,200 pF	122	J	K	M	CB	CB	CB	CB	CB	CB	CB	DC	DC	DC	DC	DC	DC	DC	DC	
1,500 pF	152	J	K	M	CB	CB	CB	CB	CB	CB	CB	DC	DC	DC	DC	DC	DC	DC	DC	
1,800 pF	182	J	K	M	CB	CB	CB	CB	CB	CB	CB	DC	DC	DC	DC	DC	DC	DC	DC	
2,200 pF	222	J	K	M	CB	CB	CB	CB	CB	CF	CB	DC	DC	DC	DC	DC	DC	DC	DC	
2,700 pF	272	J	K	M	CB	CB	CB	CB	CB	CF	CB	DC	DC	DC	DC	DC	DC	DC	DC	
3,300 pF	332	J	K	M	CB	CB	CB	CB	CB	CB	CB	DC	DC	DC	DC	DC	DC	DC	DC	
3,900 pF	392	J	K	M	CB	CB	CB	CB	CB	CB	CB	DC	DC	DC	DC	DC	DC	DC	DC	
4,700 pF	472	J	K	M	CB	CB	CB	CB	CB	CB	CB	DC	DC	DC	DC	DC	DC	DC	DC	
5,600 pF	562	J	K	M	CB	CB	CB	CB	CB	CB	CB	DC	DC	DC	DC	DC	DC	DC	DC	
6,800 pF	682	J	K	M	CB	CB	CB	CB	CB	CB	CB	DC	DC	DC	DC	DC	DC	DC	DC	
8,200 pF	822	J	K	M	CB	CB	CB	CB	CB	CB	CB	DC	DC	DC	DC	DC	DC	DC	DC	
10,000 pF	103	J	K	M	CB	CB	CB	CB	CB	CF	CB	DC	DC	DC	DC	DC	DC	DC	DC	
12,000 pF	123	J	K	M	CB	CB	CB	CB	CB	CB	CB	DC	DC	DC	DC	DC	DC	DC	DC	
15,000 pF	153	J	K	M	CB	CB	CB	CB	CB	CB	CB	DC	DC	DC	DC	DC	DD	DC	DC	
18,000 pF	183	J	K	M	CB	CB	CB	CB	CB	CB	CB	DC	DC	DC	DC	DC	DD	DC	DC	
22,000 pF	223	J	K	M	CB	CB	CB	CB	CB	CB	CB	DC	DC	DC	DC	DC	DD	DC	DC	
27,000 pF	273	J	K	M								DC	DC	DC	DC	DC		DC	DC	
33,000 pF	333	J	K	M								DC	DC	DC	DC	DC		DC	DC	
39,000 pF	393	J	K	M								DC	DC	DC	DC	DC		DC	DC	
47,000 pF	473	J	K	M								DC	DC	DC	DC	DC		DC	DC	
56,000 pF	563	J	K	M								DD	DD	DD	DD	DD		DC	DC	
68,000 pF	683	J	K	M								DD	DD	DD	DD	DD		DC	DC	
82,000 pF	823	J	K	M								DG	DG	DG	DG	DG		DC	DC	
0.10 µF	104	J	K	M								DG	DG	DG	DG	DG		DC	DC	
Capacitance	Cap Code	Rated Voltage (VDC)			6.3	10	16	25	50	100	200	6.3	10	16	25	50	100	200	250	
		Voltage Code			9	8	4	3	5	1	2	9	8	4	3	5	1	2	A	
		Case Size / Series			C0603Y								C0805Y							

Table 2 – Chip Thickness/Packaging Quantities

Thickness Code	Case Size	Thickness ± Range (mm)	Paper Quantity		Plastic Quantity	
			7" Reel	13" Reel	7" Reel	13" Reel
CB	0603	0.80 ± 0.07	4,000	10,000	0	0
CF	0603	0.80 ± 0.07	4,000	15,000	0	0
DC	0805	0.78 ± 0.10	0	0	4,000	10,000
DD	0805	0.90 ± 0.10	0	0	4,000	10,000
DG	0805	1.25 ± 0.15	0	0	2,500	10,000
EB	1206	0.78 ± 0.10	4,000	10,000	4,000	10,000
EC	1206	0.90 ± 0.10	0	0	4,000	10,000
FB	1210	0.78 ± 0.10	0	0	4,000	10,000
FC	1210	0.90 ± 0.10	0	0	4,000	10,000
FD	1210	0.95 ± 0.10	0	0	4,000	10,000
GB	1812	1.00 ± 0.10	0	0	1,000	4,000
Thickness Code	Case Size	Thickness ± Range (mm)	7" Reel	13" Reel	7" Reel	13" Reel
			Paper Quantity		Plastic Quantity	

Package quantity based on finished chip thickness specifications.

Table 3 – Chip Capacitor Land Pattern Design Recommendations per IPC–7351

EIA Size Code	Metric Size Code	Density Level A: Maximum (Most) Land Protrusion (mm)					Density Level B: Median (Nominal) Land Protrusion (mm)					Density Level C: Minimum (Least) Land Protrusion (mm)				
		C	Y	X	V1	V2	C	Y	X	V1	V2	C	Y	X	V1	V2
0603	1608	0.85	1.25	1.10	4.00	2.10	0.75	1.05	1.00	3.10	1.50	0.65	0.85	0.90	2.40	1.20
0805	2012	1.00	1.35	1.55	4.40	2.60	0.90	1.15	1.45	3.50	2.00	0.80	0.95	1.35	2.80	1.70
1206	3216	1.60	1.65	1.90	5.90	2.90	1.50	1.45	1.80	5.00	2.30	1.40	1.25	1.70	4.30	2.00
1210	3225	1.60	1.65	2.80	5.90	3.80	1.50	1.45	2.70	5.00	3.20	1.40	1.25	2.60	4.30	2.90
1812	4532	2.10	1.80	3.60	7.00	4.60	2.00	1.60	3.50	6.10	4.00	1.90	1.40	3.40	5.40	3.70

Density Level A: For low-density product applications. Recommended for wave solder applications and provides a wider process window for reflow solder processes. KEMET only recommends wave soldering of EIA 0603, 0805 and 1206 case sizes.

Density Level B: For products with a moderate level of component density. Provides a robust solder attachment condition for reflow solder processes.

Density Level C: For high component density product applications. Before adapting the minimum land pattern variations the user should perform qualification testing based on the conditions outlined in IPC Standard 7351 (IPC–7351).

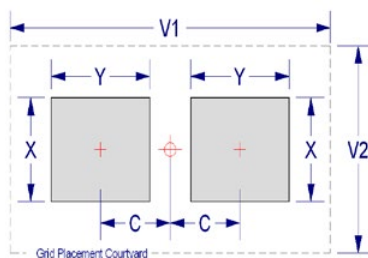

Soldering Process

Recommended Soldering Technique:

- Solder wave or solder reflow for EIA case sizes 0603, 0805 and 1206
- All other EIA case sizes are limited to solder reflow only

Recommended Soldering Profile:

- KEMET recommends following the guidelines outlined in IPC/JEDEC J-STD-020

Table 4 – Performance & Reliability: Test Methods and Conditions

Stress	Reference	Test or Inspection Method
Terminal Strength	JIS-C-6429	Appendix 1, Note: Force of 1.8 kg for 60 seconds.
Board Flex	JIS-C-6429	Appendix 2, Note: Standard termination system – 2.0 mm (minimum) for all except 3 mm for COG. Flexible termination system – 3.0 mm (minimum).
Solderability	J-STD-002	Magnification 50 X. Conditions:
		a) Method B, 4 hours @ 155°C, dry heat @ 235°C
		b) Method B @ 215°C category 3
		c) Method D, category 3 @ 260°C
Temperature Cycling	JESD22 Method JA-104	1,000 Cycles (-55°C to +125°C). Measurement at 24 hours +/- 2 hours after test conclusion.
Biased Humidity	MIL-STD-202 Method 103	Load Humidity: 1,000 hours 85°C/85% RH and rated voltage. Add 100 K ohm resistor. Measurement at 24 hours +/- 2 hours after test conclusion.
		Low Volt Humidity: 1,000 hours 85°C/85% RH and 1.5 V. Add 100 K ohm resistor. Measurement at 24 hours +/- 2 hours after test conclusion.
Moisture Resistance	MIL-STD-202 Method 106	t = 24 hours/cycle. Steps 7a and 7b not required. Unpowered. Measurement at 24 hours +/- 2 hours after test conclusion.
Thermal Shock	MIL-STD-202 Method 107	-55°C/+125°C. Note: Number of cycles required – 300, maximum transfer time – 20 seconds, dwell time – 15 minutes. Air – Air.
High Temperature Life	MIL-STD-202 Method 108 /EIA-198	1,000 hours at 125°C (85°C for X5R, Z5U and Y5V) with 2 X rated voltage applied.
Storage Life	MIL-STD-202 Method 108	150°C, 0 VDC for 1,000 hours.
Vibration	MIL-STD-202 Method 204	5 g's for 20 min., 12 cycles each of 3 orientations. Note: Use 8" X 5" PCB 0.031" thick 7 secure points on one long side and 2 secure points at corners of opposite sides. Parts mounted within 2" from any secure point. Test from 10 – 2,000 Hz
Mechanical Shock	MIL-STD-202 Method 213	Figure 1 of Method 213, Condition F.
Resistance to Solvents	MIL-STD-202 Method 215	Add aqueous wash chemical, OKEM Clean or equivalent.

Storage and Handling

Ceramic chip capacitors should be stored in normal working environments. While the chips themselves are quite robust in other environments, solderability will be degraded by exposure to high temperatures, high humidity, corrosive atmospheres, and long term storage. In addition, packaging materials will be degraded by high temperature– reels may soften or warp and tape peel force may increase. KEMET recommends that maximum storage temperature not exceed 40°C and maximum storage humidity not exceed 70% relative humidity. Temperature fluctuations should be minimized to avoid condensation on the parts and atmospheres should be free of chlorine and sulfur bearing compounds. For optimized solderability chip stock should be used promptly, preferably within 1.5 years of receipt.

Construction

Reference	Item	Material
A	Termination System	Finish 100% Matte Sn SnPb (5% min)
B		Barrier Layer Ni
C		Epoxy Layer Ag
D		Base Metal Cu
E	Inner Electrode	Ni
F	Dielectric Material	BaTiO ₃

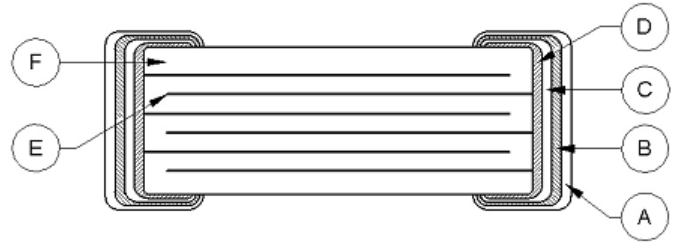

Note: Image is exaggerated in order to clearly identify all components of construction.

Overview

KEMET Power Solutions (KPS) Commercial Series stacked capacitors utilize a proprietary lead-frame technology to vertically stack one or two multilayer ceramic chip capacitors into a single compact surface mount package. The attached lead-frame mechanically isolates the capacitor/s from the printed circuit board, therefore offering advanced mechanical and thermal stress performance. Isolation also addresses concerns for audible, microphonic noise that may occur when a bias voltage is applied. A two chip stack offers up to double the capacitance in the same or smaller design footprint when compared to traditional surface mount MLCCs devices. Providing up to 10 mm of board flex capability, KPS Series

capacitors are environmentally friendly and in compliance with RoHS legislation. Available in X7R dielectric, these devices are capable of Pb-Free reflow profiles and provide lower ESR, ESL and higher ripple current capability when compared to other dielectric solutions.

Combined with the stability of an X7R dielectric, KEMET's KPS Series devices exhibit a predictable change in capacitance with respect to time and voltage and boast a minimal change in capacitance with reference to ambient temperature. Capacitance change is limited to $\pm 15\%$ from -55°C to $+125^{\circ}\text{C}$.

Benefits

- -55°C to $+125^{\circ}\text{C}$ operating temperature range
- Reliable and robust termination system
- EIA 1210, 1812, and 2220 case sizes
- DC voltage ratings of 10 V, 16 V, 25 V, 50 V, 100 V, and 250 V
- Capacitance offerings ranging from 0.1 μF up to 47 μF
- Available capacitance tolerances of $\pm 10\%$ and $\pm 20\%$
- Higher capacitance in the same footprint
- Potential board space savings
- Advanced protection against thermal and mechanical stress
- Provides up to 10 mm of board flex capability
- Reduces audible, microphonic noise
- Extremely low ESR and ESL
- Pb-Free and RoHS Compliant
- Capable of Pb-Free reflow profiles
- Non-polar device, minimizing installation concerns
- Tantalum and electrolytic alternative

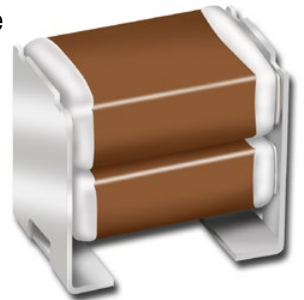

Ordering Information

C	2210	C	106	M	5	R	2	C	7186
Ceramic	Case Size (L" x W")	Specification/ Series	Capacitance Code (pF)	Capacitance Tolerance ¹	Voltage	Dielectric	Failure Rate/Design	Leadframe Finish ²	Packaging/Grade (C-Spec) ³
	1210 1812 2220	C = Standard	2 significant digits + number of zeros	K = $\pm 10\%$ M = $\pm 20\%$	8 = 10 V 4 = 16 V 3 = 25 V 5 = 50 V 1 = 100 V A = 250 V	R = X7R	1 = KPS Single Chip Stack 2 = KPS Double Chip Stack	C = 100% Matte Sn	7186 = 7" Reel Unmarked 7289 = 13" Reel Unmarked

¹ Double chip stacks ("2" in the 13th character position of the ordering code) are only available in M ($\pm 20\%$) capacitance tolerance. Single chip stacks ("1" in the 13th character position of the ordering code) are available in K ($\pm 10\%$) or M ($\pm 20\%$) tolerances.

² Additional leadframe finish options may be available. Contact KEMET for details.

³ Additional reeling or packaging options may be available. Contact KEMET for details.

Dimensions – Millimeters (Inches)

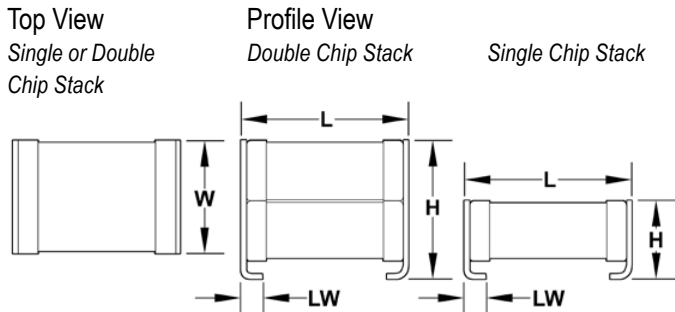

Number of Chips	EIA Size Code	Metric Size Code	L Length	W Width	H Height	LW Lead Width	Mounting Technique
Single	1210	3225	3.50 (.138) ±0.30 (.012)	2.60 (.102) ±0.30 (.012)	3.35 (.132) ±0.10 (.004)	0.80 (.032) ±0.15 (.006)	Solder Reflow Only
	1812	4532	5.00 (.197) ±0.50 (.020)	3.50 (.138) ±0.50 (.020)	2.65 (.104) ±0.35 (.014)	1.10 (.043) ±0.30 (.012)	
	2220	5650	6.00 (.236) ±0.50 (.020)	5.00 (.197) ±0.50 (.020)	3.50 (.138) ±0.30 (.012)	1.60 (.063) ±0.30 (.012)	
Double	1210	3225	3.50 (.138) ±0.30 (.012)	2.60 (.102) ±0.30 (.012)	6.15 (.242) ±0.15 (.006)	0.80 (.031) ±0.15 (.006)	
	1812	4532	5.00 (.197) ±0.50 (.020)	3.50 (.138) ±0.50 (.020)	5.00 (.197) ±0.50 (.020)	1.10 (.043) ±0.30 (.012)	
	2220	5650	6.00 (.236) ±0.50 (.020)	5.00 (.197) ±0.50 (.020)	5.00 (.197) ±0.50 (.020)	1.60 (.063) ±0.30 (.012)	

Applications

Typical applications include smoothing circuits, DC/DC converters, power supplies (input/output filters), noise reduction (piezoelectric/mechanical), circuits with a direct battery or power source connection, critical and safety relevant circuits without (integrated) current limitation and any application that is subject to high levels of board flexure or temperature cycling. Markets include industrial, military, automotive and telecom.

Qualification/Certification

Commercial Grade products are subject to internal qualification. Details regarding test methods and conditions are referenced in Table 4, Performance & Reliability.

Environmental Compliance

Pb-Free and RoHS Compliant.



RoHS Compliant

Electrical Parameters/Characteristics

Item	Parameters/Characteristics
Operating Temperature Range	-55°C to +125°C
Capacitance Change with Reference to +25°C and 0 VDC Applied (TCC)	±15%
Aging Rate (Maximum % Capacitance Loss/Decade Hour)	3.0%
Dielectric Withstanding Voltage (DWV)	250% of rated voltage (5 ±1 seconds and charge/discharge not exceeding 50 mA)
Dissipation Factor (DF) Maximum Limit @ 25°C	5%(10 V), 3.5%(16 V and 25 V) and 2.5%(50 V to 250 V)
Insulation Resistance (IR) Limit @ 25°C	See Insulation Resistance Limit Table (Rated voltage applied for 120 ±5 seconds @ 25°C)

Regarding aging rate: Capacitance measurements (including tolerance) are indexed to a referee time of 48 or 1,000 hours. Please refer to a part number specific datasheet for referee time details.

To obtain IR limit, divide $M\Omega \cdot \mu F$ value by the capacitance and compare to $G\Omega$ limit. Select the lower of the two limits.

Capacitance and dissipation factor (DF) measured under the following conditions:

1 kHz ±50 Hz and 1.0 ±0.2 Vrms if capacitance ≤ 10 μF

120 Hz ±10 Hz and 0.5 ±0.1 Vrms if capacitance > 10 μF

Note: When measuring capacitance it is important to ensure the set voltage level is held constant. The HP4284 and Agilent E4980 have a feature known as Automatic Level Control (ALC). The ALC feature should be switched to "ON."

Post Environmental Limits

High Temperature Life, Biased Humidity, Moisture Resistance					
Dielectric	Rated DC Voltage	Capacitance Value	Dissipation Factor (Maximum %)	Capacitance Shift	Insulation Resistance
X7R	> 25	All	3.0	±20%	10% of Initial Limit
	16/25		5.0		
	< 16		7.5		

Insulation Resistance Limit Table

EIA Case Size	1,000 Megohm Microfarads or 100 GΩ	500 Megohm Microfarads or 10 GΩ
1210	< 0.39 μF	≥ 0.39 μF
1812	< 2.2 μF	≥ 2.2 μF
2220	< 10 μF	≥ 10 μF

Electrical Characteristics

Z and ESR C1210C475M5R1C

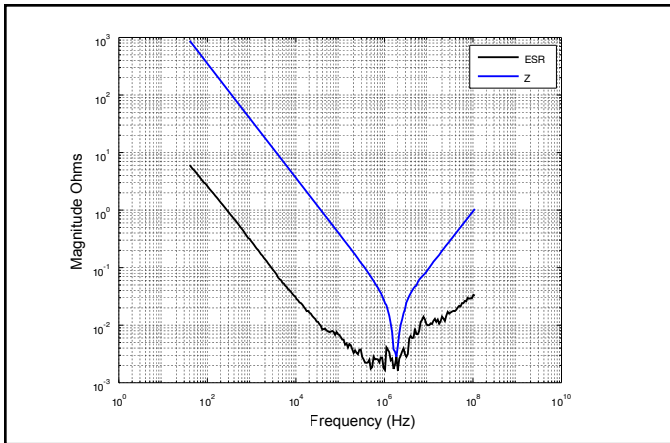

Z and ESR C2220C225MAR2C

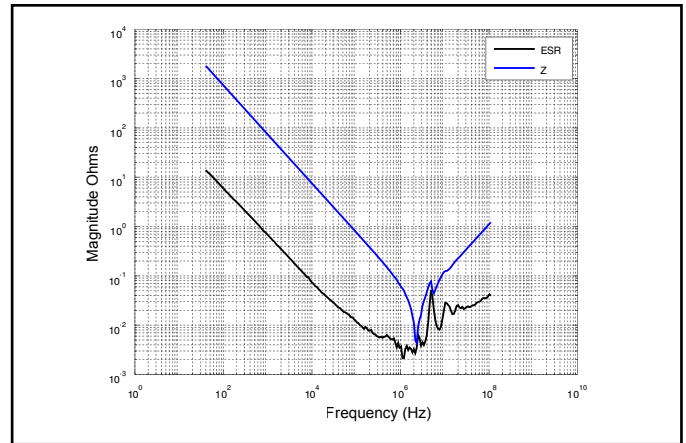

Z and ESR C2220C476M3R2C

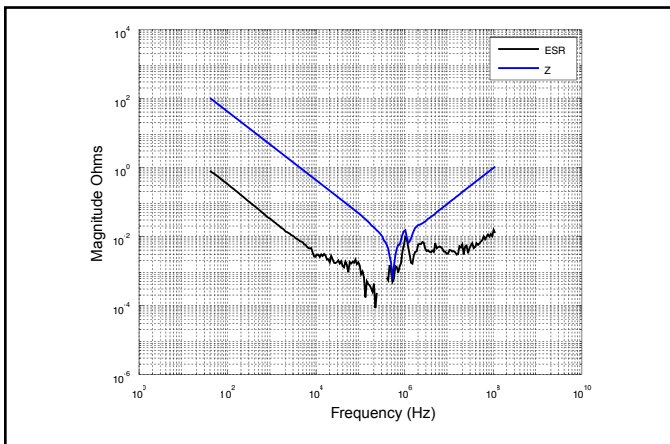

Electrical Characteristics cont'd

ESR – 1812, .10 μ F, 50 V X7R

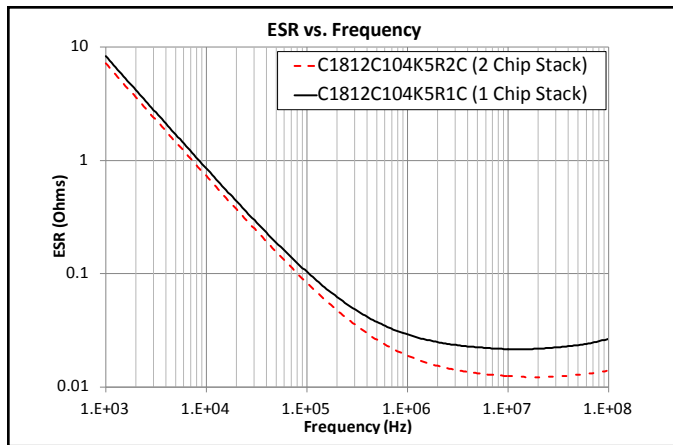

Impedance – 1812, .10 μ F, 50 V X7R

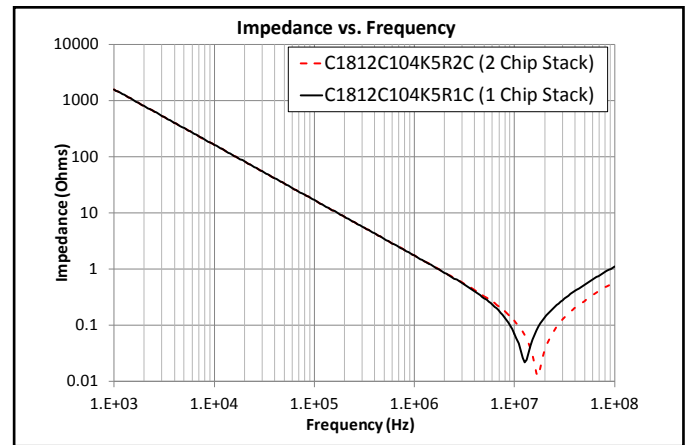

ESR – 1210, .22 μ F, 50 V X7R

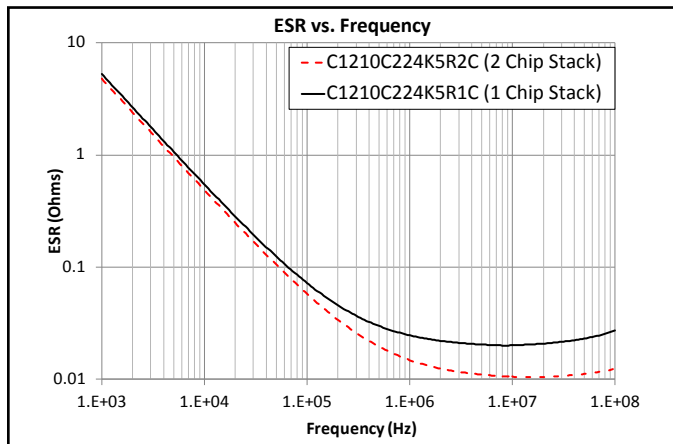

Impedance – 1210, .22 μ F, 50 V X7R

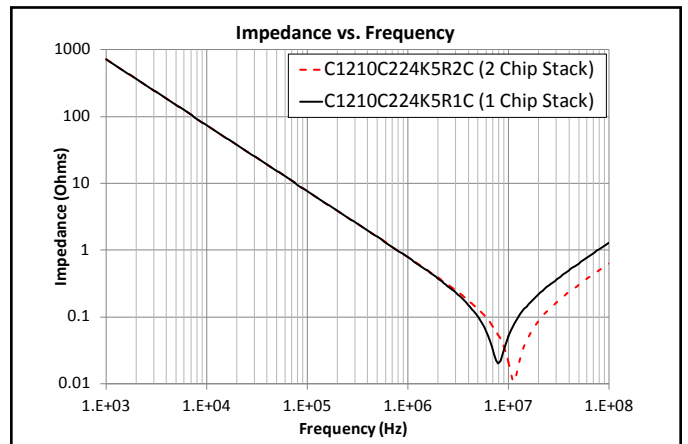

Electrical Characteristics cont'd

Microphonics – 1210, 4.7 μ F, 50 V, X7R

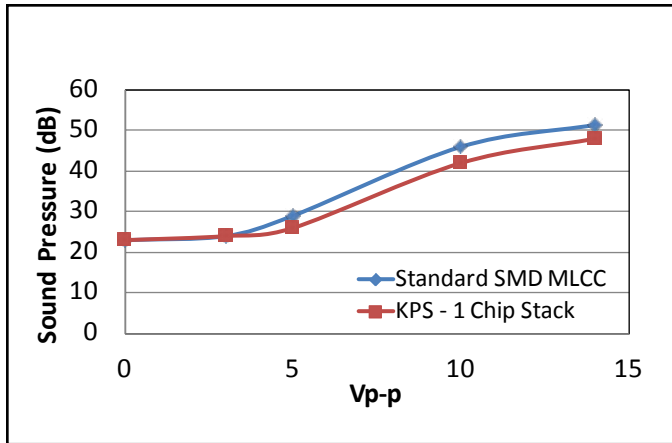

Microphonics – 2220, 22 μ F, 50 V, X7R

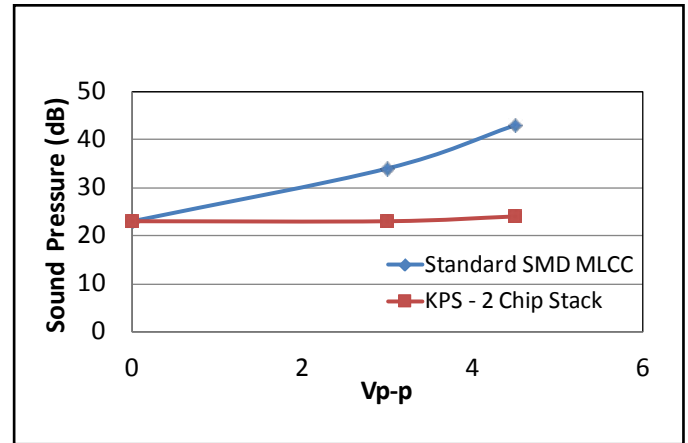

Microphonics – 2220, 47 μ F, 25 V, X7R

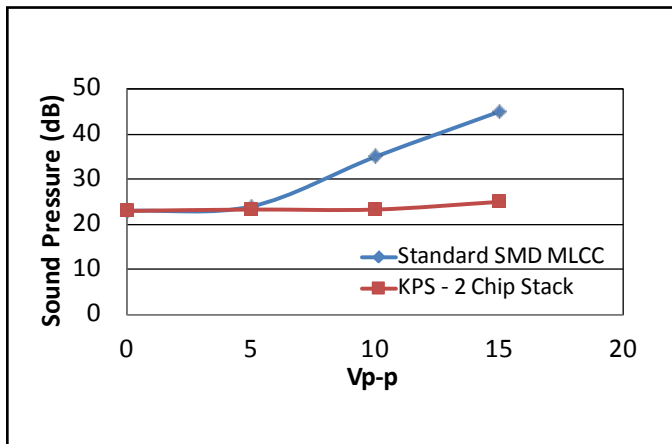

Microphonics – 1210, 22 μ F, 25 V, X7R

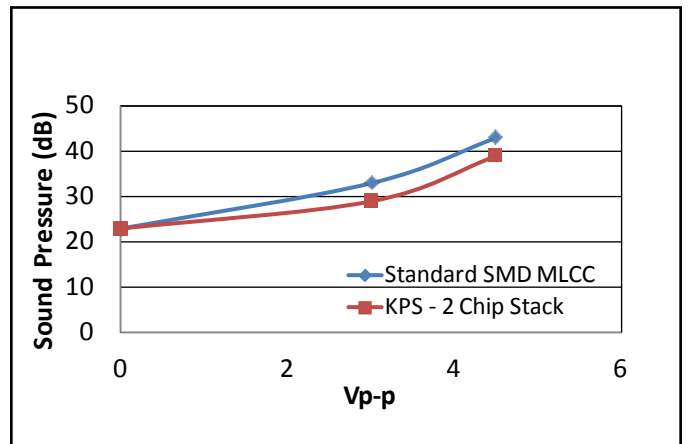

Competitive Comparison

Microphonics – 1210, 4.7 μ F, 50 V, X7R

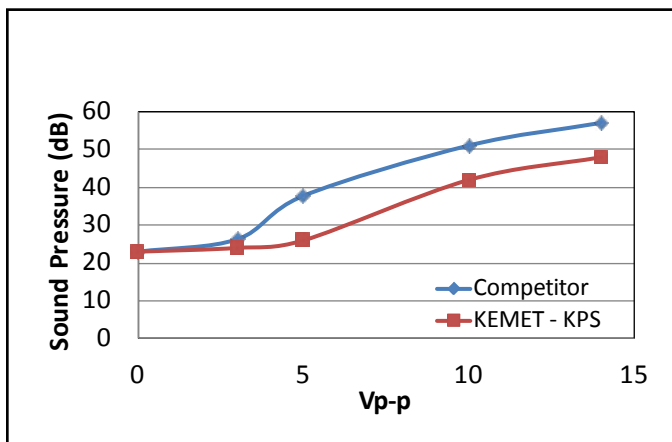

Ripple Current (Arms) 2220, 22 μ F, 50 V

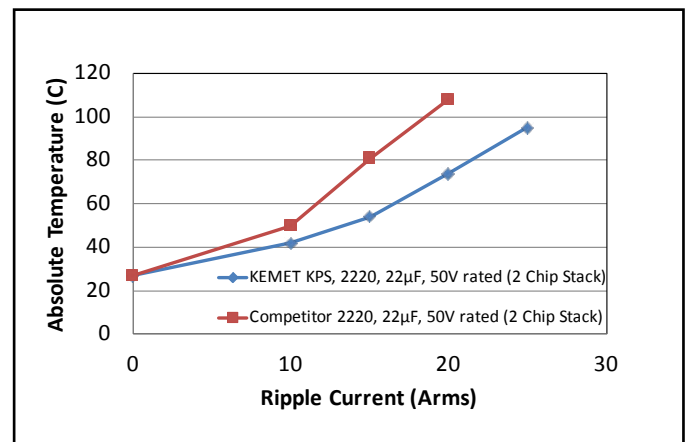

Note: Refer to Table 4 for test method.

Electrical Characteristics cont'd

Board Flex vs. Termination Type

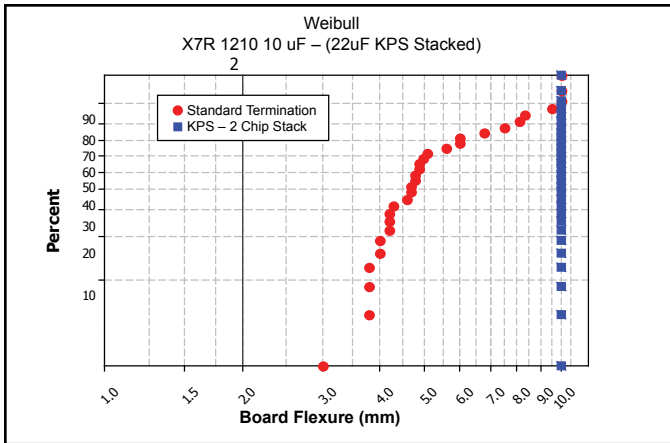

Board Flex vs. Termination Type

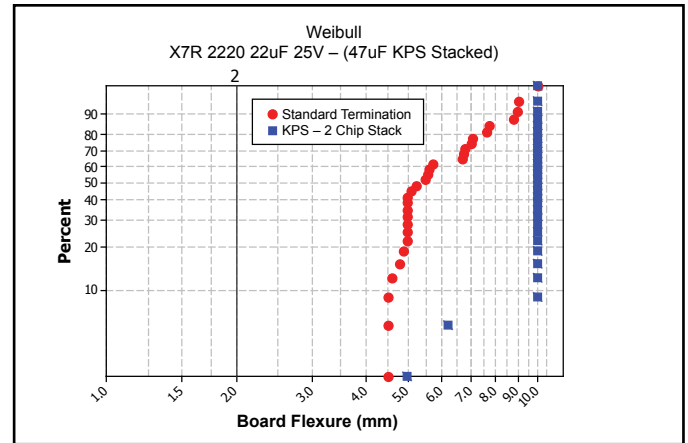

Board Flexure to 10 mm

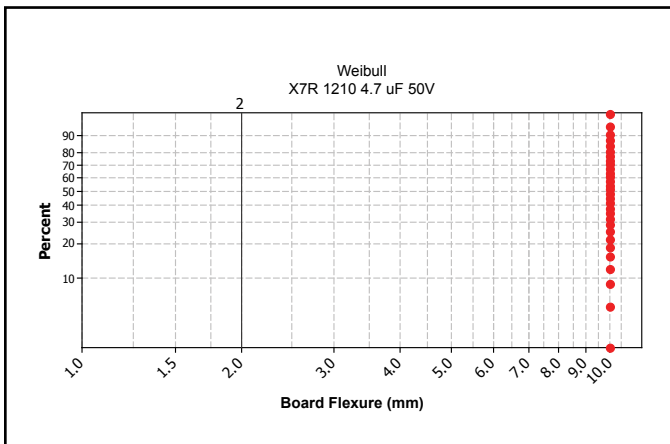

Board Flexure to 10 mm

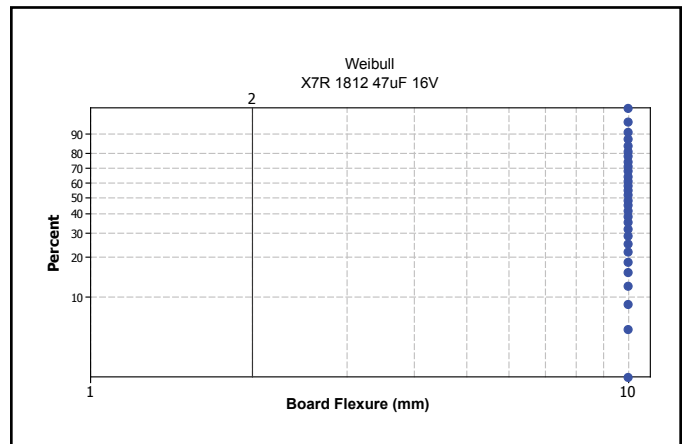

Table 1 – Capacitance Range/Selection Waterfall (1210 – 2220 Case Sizes)

Capacitance	Cap Code	Case Size / Series		C1210C						C1812C					C2220C				
		Voltage Code		8	4	3	5	1	A	4	3	5	1	A	4	3	5	1	A
		Rated Voltage (VDC)		10	16	25	50	100	250	16	25	50	100	250	16	25	50	100	250
		Capacitance Tolerance		Product Availability and Chip Thickness Codes See Table 2 for Chip Thickness Dimensions															
Single Chip Stack																			
0.10 µF	104	K	M	FV	FV	FV	FV	FV	FV	GP	GP	GP	GP	GP	JP	JP	JP	JP	JP
0.22 µF	224	K	M	FV	FV	FV	FV	FV	FV	GP	GP	GP	GP	GP	JP	JP	JP	JP	JP
0.47 µF	474	K	M	FV	FV	FV	FV	FV	FV	GP	GP	GP	GP	GP	JP	JP	JP	JP	JP
1.0 µF	105	K	M	FV	FV	FV	FV	FV	FV	GP	GP	GP	GP	GP	JP	JP	JP	JP	JP
2.2 µF	225	K	M	FV	FV	FV	FV	FV	FV	GP	GP	GP	GP	GP	JP	JP	JP	JP	JP
3.3 µF	335	K	M	FV	FV	FV	FV	FV	FV	GP	GP	GP	GP	GP	JP	JP	JP	JP	JP
4.7 µF	475	K	M	FV	FV	FV	FV	FV	FV	GP	GP	GP	GP	GP	JP	JP	JP	JP	JP
10 µF	106	K	M	FV	FV	FV	FV	FV	FV	GP	GP	GP	GP	GP	JP	JP	JP	JP	JP
15 µF	156	K	M	FV	FV	FV	FV	FV	FV	GP	GP	GP	GP	GP	JP	JP	JP	JP	JP
22 µF	226	K	M	FV	FV	FV	FV	FV	FV	GP	GP	GP	GP	GP	JP	JP	JP	JP	JP
33 µF	336	K	M	FV	FV	FV	FV	FV	FV	GP	GP	GP	GP	GP	JP	JP	JP	JP	JP
47 µF	476	K	M	FV	FV	FV	FV	FV	FV	GP	GP	GP	GP	GP	JP	JP	JP	JP	JP
100 µF	107	K	M	FV	FV	FV	FV	FV	FV	GP	GP	GP	GP	GP	JP	JP	JP	JP	JP
Double Chip Stack																			
0.10 µF	104		M	FW	FW	FW	FW	FW	FW	GR	GR	GR	GR	GR	JR	JR	JR	JR	JR
0.22 µF	224		M	FW	FW	FW	FW	FW	FW	GR	GR	GR	GR	GR	JR	JR	JR	JR	JR
0.47 µF	474		M	FW	FW	FW	FW	FW	FW	GR	GR	GR	GR	GR	JR	JR	JR	JR	JR
1.0 µF	105		M	FW	FW	FW	FW	FW	FW	GR	GR	GR	GR	GR	JR	JR	JR	JR	JR
2.2 µF	225		M	FW	FW	FW	FW	FW	FW	GR	GR	GR	GR	GR	JR	JR	JR	JR	JR
3.3 µF	335		M	FW	FW	FW	FW	FW	FW	GR	GR	GR	GR	GR	JR	JR	JR	JR	JR
4.7 µF	475		M	FW	FW	FW	FW	FW	FW	GR	GR	GR	GR	GR	JR	JR	JR	JR	JR
10 µF	106		M	FW	FW	FW	FW	FW	FW	GR	GR	GR	GR	GR	JR	JR	JR	JR	JR
22 µF	226		M	FW	FW	FW	FW	FW	FW	GR	GR	GR	GR	GR	JR	JR	JR	JR	JR
33 µF	336		M	FW	FW	FW	FW	FW	FW	GR	GR	GR	GR	GR	JR	JR	JR	JR	JR
47 µF	476		M	FW	FW	FW	FW	FW	FW	GR	GR	GR	GR	GR	JR	JR	JR	JR	JR
100 µF	107		M	FW	FW	FW	FW	FW	FW	GR	GR	GR	GR	GR	JR	JR	JR	JR	JR
220 µF	227		M	FW	FW	FW	FW	FW	FW	GR	GR	GR	GR	GR	JR	JR	JR	JR	JR
Capacitance	Cap Code	Rated Voltage (VDC)		10	16	25	50	100	250	16	25	50	100	250	16	25	50	100	250
		Voltage Code		8	4	3	5	1	A	4	3	5	1	A	4	3	5	1	A
		Case Size / Series		C1210C						C1812C					C2220C				

These products are protected under US Patent 8,331,078 other patents pending, and any foreign counterparts.

Table 2 – Chip Thickness/Packaging Quantities

Thickness Code	Case Size	Thickness ± Range (mm)	Paper Quantity		Plastic Quantity	
			7" Reel	13" Reel	7" Reel	13" Reel
FV	1210	3.35 ± 0.10	0	0	600	2,000
FW	1210	6.15 ± 0.15	0	0	300	1,000
GP	1812	2.65 ± 0.35	0	0	500	2,000
GR	1812	5.00 ± 0.50	0	0	400	1,700
JP	2220	3.50 ± 0.30	0	0	300	1,300
JR	2220	5.00 ± 0.50	0	0	200	800
Thickness Code	Case Size	Thickness ± Range (mm)	7" Reel	13" Reel	7" Reel	13" Reel
			Paper Quantity		Plastic Quantity	

Package quantity based on finished chip thickness specifications.

Table 3 – KPS Land Pattern Design Recommendations (mm)

EIA SIZE CODE	METRIC SIZE CODE	Median (Nominal) Land Protrusion				
		C	Y	X	V1	V2
1210	3225	1.50	1.14	1.75	5.05	3.40
1812	4532	2.20	1.35	2.87	6.70	4.50
2220	5650	2.69	2.08	4.78	7.70	6.00

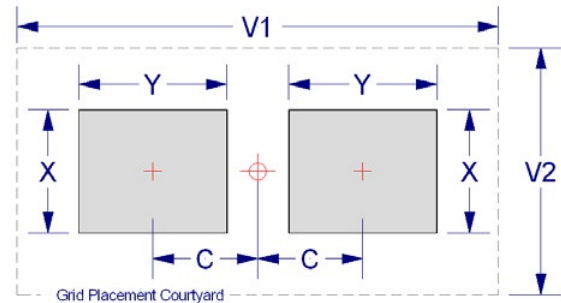

Soldering Process

KEMET's KPS Series devices are compatible with IR reflow techniques. Preheating of these components is recommended to avoid extreme thermal stress. KEMET's recommended profile conditions for IR reflow reflect the profile conditions of the IPC/J-STD-020D standard for moisture sensitivity testing.

To prevent degradation of temperature cycling capability, care must be taken to prevent solder from flowing into the inner side of the lead frames (inner side of "J" lead in contact with the circuit board).

After soldering, the capacitors should be air cooled to room temperature before further processing. Forced air cooling is not recommended.

Hand soldering should be performed with care due to the difficulty in process control. If performed, care should be taken to avoid contact of the soldering iron to the capacitor body. The iron should be used to heat the solder pad, applying solder between the pad and the lead, until reflow occurs. Once reflow occurs, the iron should be removed immediately. (Preheating is required when hand soldering to avoid thermal shock.)

Profile Feature	SnPb Assembly	Pb-Free Assembly
Preheat/Soak		
Temperature Minimum (T_{smin})	100°C	150°C
Temperature Maximum (T_{smax})	150°C	200°C
Time (t_s) from T_{smin} to T_{smax}	60 – 120 seconds	60 – 120 seconds
Ramp-up Rate (T_L to T_p)	3°C/seconds maximum	3°C/seconds maximum
Liquidous Temperature (T_L)	183°C	217°C
Time Above Liquidous (t_L)	60 – 150 seconds	60 – 150 seconds
Peak Temperature (T_p)	235°C	250°C
Time within 5°C of Maximum Peak Temperature (t_p)	20 seconds maximum	10 seconds maximum
Ramp-down Rate (T_p to T_L)	6°C/seconds maximum	6°C/seconds maximum
Time 25°C to Peak Temperature	6 minutes maximum	8 minutes maximum

Note: All temperatures refer to the center of the package, measured on the package body surface that is facing up during assembly reflow.

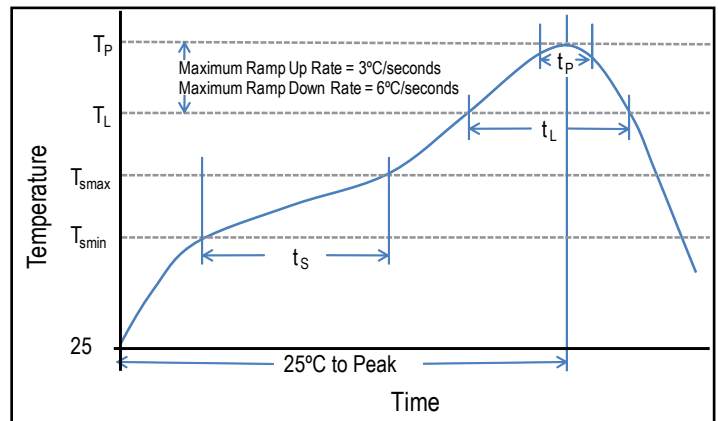

Table 4 – Performance & Reliability: Test Methods and Conditions

Stress	Reference	Test or Inspection Method
Terminal Strength	JIS-C-6429	Appendix 1, Note: Force of 1.8 kg for 60 seconds.
Board Flex	JIS-C-6429	Appendix 2, Note: 5.0 mm minimum
Solderability	J-STD-002	Magnification 50 X. Conditions:
		a) Method B, 4 hours @ 155°C, dry heat @ 235°C
		b) Method B @ 215°C category 3
		c) Method D, category 3 @ 250°C
Temperature Cycling	JESD22 Method JA-104	1,000 cycles (-55°C to +125°C). Measurement at 24 hours +/- 2 hours after test conclusion.
Biased Humidity	MIL-STD-202 Method 103	Load Humidity: 1,000 hours 85°C/85% RH and 200 VDC maximum. Add 100 K ohm resistor. Measurement at 24 hours +/- 2 hours after test conclusion.
		Low Volt Humidity: 1,000 hours 85°C/85% RH and 1.5 V. Add 100 K ohm resistor. Measurement at 24 hours +/- 2 hours after test conclusion.
Moisture Resistance	MIL-STD-202 Method 106	t = 24 hours/cycle. Steps 7a and 7b not required. Unpowered. Measurement at 24 hours +/- 2 hours after test conclusion.
Thermal Shock	MIL-STD-202 Method 107	-55°C/+125°C. Note: Number of cycles required – 300. Maximum transfer time – 20 seconds. Dwell time – 15 minutes. Air-Air.
High Temperature Life	MIL-STD-202 Method 108	1,000 hours at 125°C with rated voltage applied.
Storage Life	MIL-STD-202 Method 108	150°C, 0 VDC for 1,000 hours.
Vibration	MIL-STD-202 Method 204	5 g's for 20 minutes, 12 cycles each of 3 orientations. Note: Use 8" X 5" PCB .031" thick, 7 secure points on one long side and 2 secure points at corners of opposite sides. Parts mounted within 2" from any secure point. Test from 10 – 2,000 Hz.
Mechanical Shock	MIL-STD-202 Method 213	Figure 1 of Method 213, Condition F.
Resistance to Solvents	MIL-STD-202 Method 215	Add aqueous wash chemical, OKEM Clean or equivalent.

Storage & Handling

Ceramic chip capacitors should be stored in normal working environments. While the chips themselves are quite robust in other environments, solderability will be degraded by exposure to high temperatures, high humidity, corrosive atmospheres, and long term storage. In addition, packaging materials will be degraded by high temperature– reels may soften or warp and tape peel force may increase. KEMET recommends that maximum storage temperature not exceed 40°C and maximum storage humidity not exceed 70% relative humidity. Temperature fluctuations should be minimized to avoid condensation on the parts and atmospheres should be free of chlorine and sulfur bearing compounds. For optimized solderability chip stock should be used promptly, preferably within 1.5 years of receipt.

Construction

Reference	Item	Material
A	Leadframe	Phosphor Bronze – Alloy 510
B	Leadframe Attach	HMP Solder
C	Termination	Cu
D		Ni
E		Sn
F	Inner Electrode	Ni
G	Dielectric Material	BaTiO ₃

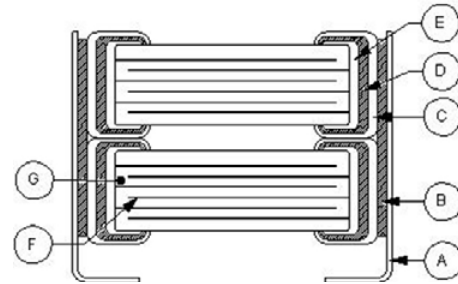

Note: Image is exaggerated in order to clearly identify all components of construction.
 HMP = High Melting Point

Product Marking

Laser marking option is not available on:

- COG, Ultra Stable X8R and Y5V dielectric devices
- EIA 0402 case size devices
- EIA 0603 case size devices with Flexible Termination option.
- KPS Commercial and Automotive grade stacked devices.

These capacitors are supplied unmarked only.

KPS Series, High Voltage, X7R Dielectric, 500 VDC – 630 VDC (Commercial Grade)

Overview

KEMET Power Solutions (KPS) High Voltage stacked capacitors utilize a proprietary lead-frame technology to vertically stack one or two multilayer ceramic chip capacitors into a single compact surface mount package. The attached lead-frame mechanically isolates the capacitor(s) from the printed circuit board, thereby offering advanced mechanical and thermal stress performance. Isolation also addresses concerns for audible microphonic noise that may occur when a bias voltage is applied. A two-chip stack offers up to double the capacitance in the same or smaller design footprint when compared to traditional surface mount MLCC devices. Providing up to 10 mm of board flex capability, KPS Series High Voltage capacitors are environmentally friendly and in compliance with RoHS legislation.

KEMET's KPS Series devices in X7R dielectric exhibit a

predictable change in capacitance with respect to time and voltage, and boast a minimal change in capacitance with reference to ambient temperature. Capacitance change is limited to $\pm 15\%$ from -55°C to $+125^{\circ}\text{C}$. These devices are capable of Pb-Free reflow profiles and provide lower ESR, ESL and higher ripple current capability when compared to other dielectric solutions.

Conventional uses include both snubbers and filters in applications such as switching power supplies and lighting ballasts. Their exceptional performance at high frequencies has made high voltage ceramic capacitors the preferred dielectric choice of design engineers worldwide. In addition to their use in power supplies, these capacitors are widely used in industries related to automotive (hybrid), telecommunications, medical, military, aerospace, semiconductors, and test/diagnostic equipment.

Benefits

- -55°C to $+125^{\circ}\text{C}$ operating temperature range
- Reliable and robust termination system
- EIA 2220 case size
- DC voltage ratings of 500 V and 630 V
- Capacitance offerings ranging from $0.047\ \mu\text{F}$ up to $1.0\ \mu\text{F}$
- Available capacitance tolerances of $\pm 10\%$ and $\pm 20\%$
- Higher capacitance in the same footprint
- Potential board space savings
- Advanced protection against thermal and mechanical stress
- Provides up to 10 mm of board flex capability
- Reduces audible microphonic noise
- Extremely low ESR and ESL
- Pb-Free and RoHS Compliant
- Capable of Pb-Free reflow profiles
- Non-polar device, minimizing installation concerns
- Film alternative



Ordering Information

C	2220	C	105	M	C	R	2	C	7186
Ceramic	Case Size (L"x W")	Specification/ Series	Capacitance Code (pF)	Capacitance Tolerance ¹	Rated Voltage (VDC)	Dielectric	Failure Rate/ Design	Leadframe Finish ²	Packaging/Grade (C-Spec) ³
	2220	C = Standard	2 significant digits + number of zeros.	K = $\pm 10\%$ M = $\pm 20\%$	C = 500 V B = 630 V	R = X7R	1 = KPS Single Chip Stack 2 = KPS Double Chip Stack	C = 100% Matte Sn	7186 = 7" Reel Unmarked 7289 = 13" Reel Unmarked

¹ Double chip stacks ("2" in the 13th character position of the ordering code) are only available in M ($\pm 20\%$) capacitance tolerance.

Single chip stacks ("1" in the 13th character position of the ordering code) are available in K ($\pm 10\%$) or M ($\pm 20\%$) tolerances.

² Additional leadframe finish options may be available. Contact KEMET for details.

³ Additional reeling or packaging options may be available. Contact KEMET for details.

Dimensions – Millimeters (Inches)

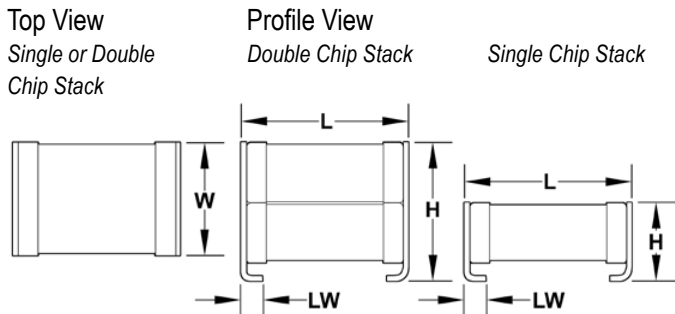

Number of Chips	EIA Size Code	Metric Size Code	L Length	W Width	H Height	LW Lead Width	Mounting Technique
Single	2220	5650	6.00 (0.236) ±0.50 (0.020)	5.00 (.197) ±0.50 (.020)	3.50 (.138) ±0.30 (.012)	1.60 (.063) ±0.30 (.012)	Solder Reflow Only
Double	2220	5650	6.00 (0.236) ±0.50 (0.020)	5.00 (.197) ±0.50 (.020)	5.00 (.197) ±0.50 (.020)	1.60 (.063) ±0.30 (.012)	

Applications

Typical applications include switch mode power supplies (input filters, resonators, tank circuits, snubber circuits, output filters), high voltage coupling and DC blocking, lighting ballasts, voltage multiplier circuits, DC/DC converters and coupling capacitors in Ćuk converters. Markets include power supply, LCD fluorescent backlight ballasts, HID lighting, telecom equipment, industrial and medical equipment/control, LAN/WAN interface, analog and digital modems, and automotive (electric and hybrid vehicles, charging stations and lighting applications).

Application Note

X7R dielectric is not recommended for AC line filtering or pulse applications.

Qualification/Certification

Commercial Grade products are subject to internal qualification. Details regarding test methods and conditions are referenced in Table 4 , Performance and Reliability.

Environmental Compliance

Pb-Free and RoHS Compliant.



RoHS Compliant

Electrical Parameters/Characteristics

Item	Parameters/Characteristics
Operating Temperature Range	-55°C to +125°C
Capacitance Change with Reference to +25°C and 0 VDC Applied (TCC)	±15%
Aging Rate (Maximum % Capacitance Loss/Decade Hour)	3.0%
Dielectric Withstanding Voltage (DWV)	150% of rated voltage for voltage rating of < 1,000 V 120% of rated voltage for voltage rating of ≥ 1,000 V (5 ±1 seconds and charge/discharge not exceeding 50 mA)
Dissipation Factor (DF) Maximum Limit @ 25°C	2.5%
Insulation Resistance (IR) Limit @ 25°C	See Insulation Resistance Limit Table (500 VDC applied for 120 ±5 seconds @ 25°C)

Regarding Aging Rate: Capacitance measurements (including tolerance) are indexed to a referee time of 1,000 hours.

To obtain IR limit, divide $M\Omega - \mu F$ value by the capacitance and compare to $G\Omega$ limit. Select the lower of the two limits.

Capacitance and Dissipation Factor (DF) measured under the following conditions:

1 kHz ±50 Hz and 1.0 ±0.2 Vrms if capacitance ≤ 10 μF

120 Hz ±10 Hz and 0.5 ±0.1 Vrms if capacitance >10 μF

Note: When measuring capacitance it is important to ensure the set voltage level is held constant. The HP4284 and Agilent E4980 have a feature known as Automatic Level Control (ALC). The ALC feature should be switched to "ON."

Post Environmental Limits

High Temperature Life, Biased Humidity, Moisture Resistance					
Dielectric	Rated DC Voltage	Capacitance Value	Dissipation Factor (Maximum %)	Capacitance Shift	Insulation Resistance
X7R	> 25	All	3.0	±20%	10% of Initial Limit
	16/25		5.0		
	< 16		7.5		

Insulation Resistance Limit Table

EIA Case Size	1,000 megohm microfarads or 100 GΩ	100 megohm microfarads or 10 GΩ
0805	< 0.0039 μF	≥ 0.0039 μF
1206	< 0.012 μF	≥ 0.012 μF
1210	< 0.033 μF	≥ 0.033 μF
1808	< 0.018 μF	≥ 0.018 μF
1812	< 0.027 μF	≥ 0.027 μF
≥ 1825	All	N/A

Table 1 – Capacitance Range/Selection Waterfall (2220 Case Sizes)

Capacitance	Capacitance Code	Case Size / Series		C2220C		
		Voltage Code		C	B	D
		Rated Voltage (VDC)		500	630	1000
		Capacitance Tolerance		Product Availability and Chip Thickness Codes – See Table 2 for Chip Thickness Dimensions		
Single Chip Stack						
0.047 μF	473	K	M	JP	JP	
0.10 μF	104	K	M	JP	JP	
0.15 μF	154	K	M	JP	JP	
0.22 μF	224	K	M	JP	JP	
0.33 μF	334	K	M	JP	JP	
0.47 μF	474	K	M	JP		
Double Chip Stack						
0.10 μF	104		M	JR	JR	
0.22 μF	224		M	JR	JR	
0.33 μF	334		M	JR	JR	
0.47 μF	474		M	JR	JR	
0.68 μF	664		M	JR		
1.0 μF	105		M	JR		
Capacitance	Capacitance Code	Rated Voltage (VDC)		500	630	1000
		Voltage Code		C	B	D
		Case Size / Series		C2220C		

Table 2 – Chip Thickness/Packaging Quantities

Thickness Code	Case Size	Thickness ± Range (mm)	Paper Quantity		Plastic Quantity	
			7" Reel	13" Reel	7" Reel	13" Reel
JP	2220	3.50 ± 0.30	0	0	300	1,300
JR	2220	5.00 ± 0.50	0	0	200	800

Package quantity based on finished chip thickness specifications.

Table 3 – KPS Land Pattern Design Recommendations (mm)

EIA SIZE CODE	METRIC SIZE CODE	Median (Nominal) Land Protrusion				
		C	Y	X	V1	V2
1210	3225	1.50	1.14	1.75	5.05	3.40
1812	4532	2.20	1.35	2.87	6.70	4.50
2220	5650	2.69	2.08	4.78	7.70	6.00

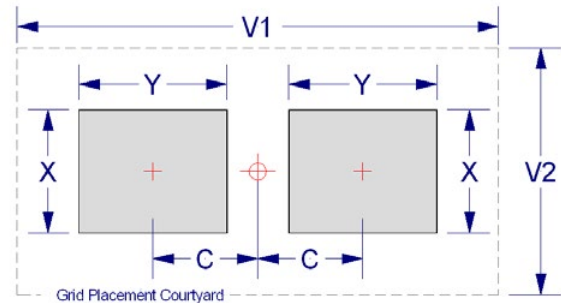

Soldering Process

KEMET's KPS Series devices are compatible with IR reflow techniques. Preheating of these components is recommended to avoid extreme thermal stress. KEMET's recommended profile conditions for IR reflow reflect the profile conditions of the IPC/J-STD-020D standard for moisture sensitivity testing.

To prevent degradation of temperature cycling capability, care must be taken to prevent solder from flowing into the inner side of the lead frames (inner side of "J" lead in contact with the circuit board).

After soldering, the capacitors should be air cooled to room temperature before further processing. Forced air cooling is not recommended.

Hand soldering should be performed with care due to the difficulty in process control. If performed, care should be taken to avoid contact of the soldering iron to the capacitor body. The iron should be used to heat the solder pad, applying solder between the pad and the lead, until reflow occurs. Once reflow occurs, the iron should be removed immediately. (Preheating is required when hand soldering to avoid thermal shock.)

Profile Feature	SnPb Assembly	Pb-Free Assembly
Preheat/Soak		
Temperature Minimum (T_{Smin})	100°C	150°C
Temperature Maximum (T_{Smax})	150°C	200°C
Time (t_s) from T_{Smin} to T_{Smax}	60 – 120 seconds	60 – 120 seconds
Ramp-up Rate (T_L to T_p)	3°C/seconds maximum	3°C/seconds maximum
Liquidous Temperature (T_L)	183°C	217°C
Time Above Liquidous (t_L)	60 – 150 seconds	60 – 150 seconds
Peak Temperature (T_p)	235°C	250°C
Time within 5°C of Maximum Peak Temperature (t_p)	20 seconds maximum	10 seconds maximum
Ramp-down Rate (T_p to T_L)	6°C/seconds maximum	6°C/seconds maximum
Time 25°C to Peak Temperature	6 minutes maximum	8 minutes maximum

Note: All temperatures refer to the center of the package, measured on the package body surface that is facing up during assembly reflow.

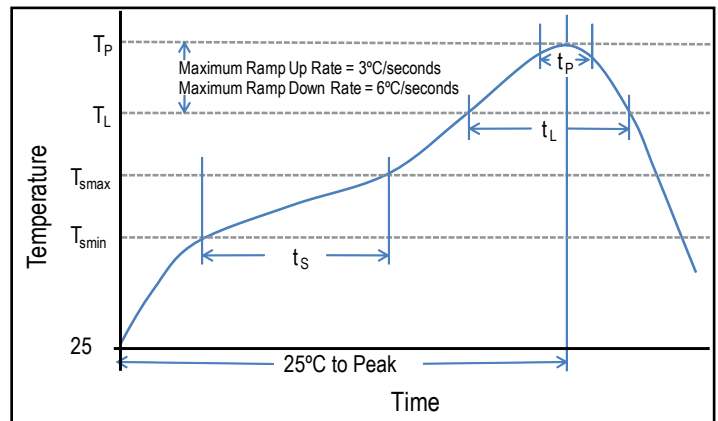

Table 4 – Performance & Reliability: Test Methods and Conditions

Stress	Reference	Test or Inspection Method
Terminal Strength	JIS-C-6429	Appendix 1, Note: Force of 1.8 kg for 60 seconds.
Board Flex	JIS-C-6429	Appendix 2, Note: 5.0 mm minimum
Solderability	J-STD-002	Magnification 50 X. Conditions:
		a) Method B, 4 hours @ 155°C, dry heat @ 235°C
		b) Method B @ 215°C category 3
		c) Method D, category 3 @ 250°C
Temperature Cycling	JESD22 Method JA-104	1,000 cycles (-55°C to +125°C). Measurement at 24 hours +/- 2 hours after test conclusion.
Biased Humidity	MIL-STD-202 Method 103	Load Humidity: 1,000 hours 85°C/85% RH and 200 VDC maximum. Add 100 K ohm resistor. Measurement at 24 hours +/- 2 hours after test conclusion.
		Low Volt Humidity: 1,000 hours 85°C/85% RH and 1.5 V. Add 100 K ohm resistor. Measurement at 24 hours +/- 2 hours after test conclusion.
Moisture Resistance	MIL-STD-202 Method 106	t = 24 hours/cycle. Steps 7a and 7b not required. Unpowered. Measurement at 24 hours +/- 2 hours after test conclusion.
Thermal Shock	MIL-STD-202 Method 107	-55°C/+125°C. Note: Number of cycles required – 300. Maximum transfer time – 20 seconds. Dwell time – 15 minutes. Air-Air.
High Temperature Life	MIL-STD-202 Method 108	1,000 hours at 125°C with rated voltage applied.
Storage Life	MIL-STD-202 Method 108	150°C, 0 VDC for 1,000 hours.
Vibration	MIL-STD-202 Method 204	5 g's for 20 minutes, 12 cycles each of 3 orientations. Note: Use 8" X 5" PCB 0.031" thick, 7 secure points on one long side and 2 secure points at corners of opposite sides. Parts mounted within 2" from any secure point. Test from 10 – 2,000 Hz.
Mechanical Shock	MIL-STD-202 Method 213	Figure 1 of Method 213, Condition F.
Resistance to Solvents	MIL-STD-202 Method 215	Add aqueous wash chemical, OKEM Clean or equivalent.

Storage and Handling

Ceramic chip capacitors should be stored in normal working environments. While the chips themselves are quite robust in other environments, solderability will be degraded by exposure to high temperatures, high humidity, corrosive atmospheres, and long term storage. In addition, packaging materials will be degraded by high temperature– reels may soften or warp and tape peel force may increase. KEMET recommends that maximum storage temperature not exceed 40°C and maximum storage humidity not exceed 70% relative humidity. Temperature fluctuations should be minimized to avoid condensation on the parts and atmospheres should be free of chlorine and sulfur bearing compounds. For optimized solderability chip stock should be used promptly, preferably within 1.5 years of receipt.

Construction

Reference	Item	Material
A	Leadframe	Phosphor Bronze – Alloy 510
B	Leadframe Attach	HMP Solder
C	Termination	Cu
D		Ni
E		Sn
F	Inner Electrode	Ni
G	Dielectric Material	BaTiO ₃

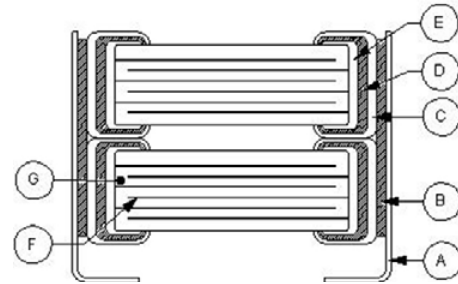

Note: Image is exaggerated in order to clearly identify all components of construction.
 HMP = High Melting Point

Product Marking

Laser marking option is not available on:

- COG, Ultra Stable X8R and Y5V dielectric devices
- EIA 0402 case size devices
- EIA 0603 case size devices with Flexible Termination option.
- KPS Commercial and Automotive grade stacked devices.

These capacitors are supplied unmarked only.

KPS HT Series, High Temperature 150°C, X8L Dielectric, 10 VDC – 50 VDC (Commercial & Automotive Grade)

Overview

KEMET Power Solutions High Temperature (KPS HT) stacked capacitors utilize a proprietary lead-frame technology to vertically stack one or two multilayer ceramic chip capacitors into a single compact surface mount package. The attached lead-frame mechanically isolates the capacitor(s) from the printed circuit board, thereby offering advanced mechanical and thermal stress performance. Isolation also addresses concerns for audible, microphonic noise that may occur when a bias voltage is applied. A two-chip stack offers up to double the capacitance in the same or smaller design footprint when compared to traditional surface mount MLCC devices. Providing up to 10 mm of board flex capability, KPS Series capacitors are environmentally friendly and in compliance with RoHS legislation. Combined with X8L dielectric, these devices are

capable of reliable operation up to 150°C and are well suited for high temperature filtering, bypass and decoupling applications.

X8L exhibits a predictable change in capacitance with respect to time and voltage, and boasts a minimal change in capacitance with reference to ambient temperature up to 125°C. Beyond 125°C, X8L displays a wider variation in capacitance. Capacitance change is limited to $\pm 15\%$ from -55°C to +125°C and +15, -40% from 125°C to 150°C.

In addition to Commercial grade, Automotive grade devices are available and meet the demanding Automotive Electronics Council's AEC-Q200 qualification requirements.

Benefits

- -55°C to +150°C operating temperature range
- Reliable and robust termination system
- EIA 1210 and 2220 case sizes
- DC voltage ratings of 10 V, 16 V, 25 V, and 50 V
- Capacitance offerings ranging from 0.47 μF up to 47 μF
- Available capacitance tolerances of $\pm 10\%$ and $\pm 20\%$
- Higher capacitance in the same footprint
- Potential board space savings
- Advanced protection against thermal and mechanical stress
- Provides up to 10 mm of board flex capability
- Reduces audible, microphonic noise
- Extremely low ESR and ESL
- Pb-Free and RoHS Compliant
- Capable of Pb-Free reflow profiles
- Non-polar device, minimizing installation concerns
- Tantalum and electrolytic alternative
- Commercial & Automotive (AEC-Q200) grades available



Ordering Information

C	2220	C	476	M	4	N	2	C	7186
Ceramic	Case Size (L"x W")	Specification/ Series	Capacitance Code (pF)	Capacitance Tolerance ¹	Rated Voltage (VDC)	Dielectric	Failure Rate/ Design	Leadframe Finish	Packaging/Grade (C-Spec)
	1210 2220	C = Standard	2 significant digits + number of zeros.	K = $\pm 10\%$ M = $\pm 20\%$	8 = 10 V 4 = 16 V 3 = 25 V 5 = 50 V	N = X8L	1 = KPS Single Chip Stack 2 = KPS Double Chip Stack	C = 100% Matte Sn	7186 = 7" Reel Unmarked 7289 = 13" Reel Unmarked AUTO = Automotive Grade 7" Reel Unmarked AUTO7289 = Automotive Grade 13" Reel Unmarked

¹ Double chip stacks ("2" in the 13th character position of the ordering code) are only available in M ($\pm 20\%$) capacitance tolerance.

Dimensions – Millimeters (Inches)

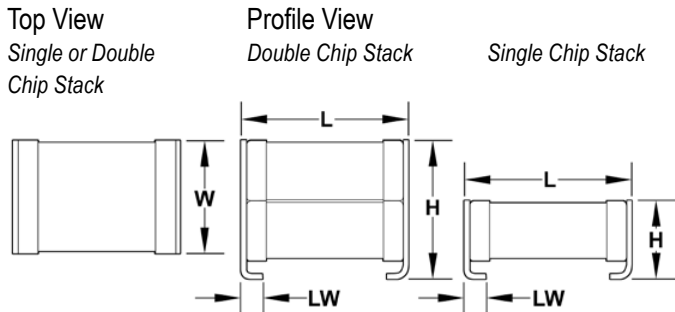

Chip Stack	EIA Size Code	Metric Size Code	L Length	W Width	H Height	LW Lead Width	Mounting Technique
Single	1210	3225	3.50 (.138) ±0.30 (.012)	2.60 (.102) ±0.30 (.012)	3.35 (.132) ±0.10 (.004)	0.80 (.032) ±0.15 (.006)	Solder Reflow Only
	2220	5650	6.00 (.236) ±0.50 (.020)	5.00 (.197) ±0.50 (.020)	3.50 (.138) ±0.30 (.012)	1.60 (.063) ±0.30 (.012)	
Double	1210	3225	3.50 (.138) ±0.30 (.012)	2.60 (.102) ±0.30 (.012)	6.15 (.242) ±0.15 (.006)	0.80 (.031) ±0.15 (.006)	
	2220	5650	6.00 (.236) ±0.50 (.020)	5.00 (.197) ±0.50 (.020)	5.00 (.197) ±0.50 (.020)	1.60 (.063) ±0.30 (.012)	

Applications

Typical applications include smoothing circuits, DC/DC converters, power supplies (input/output filters), noise reduction (piezoelectric/mechanical), circuits with a direct battery or power source connection, critical and safety relevant circuits without (integrated) current limitation and any application that is subject to extreme environments such as high temperature, high levels of board flexure and/or temperature cycling. Markets include industrial, aerospace, automotive, and telecom.

Qualification/Certification

Commercial Grade products are subject to internal qualification. Details regarding test methods and conditions are referenced in Table 4, Performance & Reliability.

Automotive Grade products meet or exceed the requirements outlined by the Automotive Electronics Council. Details regarding test methods and conditions are referenced in document AEC-Q200, Stress Test Qualification for Passive Components. For additional information regarding the Automotive Electronics Council and AEC-Q200, please visit their website at www.aecouncil.com.

Environmental Compliance

Pb-Free and RoHS Compliant.



RoHS Compliant

Electrical Parameters/Characteristics

Item	Parameters/Characteristics
Operating Temperature Range	-55°C to +150°C
Capacitance Change with Reference to +25°C and 0 VDC Applied (TCC)	±15% (-55°C to 125°C), +15, -40% (125°C to 150°C)
Aging Rate (Maximum % Capacitance Loss/Decade Hour)	3.0%
Dielectric Withstanding Voltage (DWV)	250% of rated voltage (5 ±1 seconds and charge/discharge not exceeding 50 mA)
Dissipation Factor (DF) Maximum Limit @ 25°C	3.5% (10 V and 16 V) and 2.5% (25 V and 50 V)
Insulation Resistance (IR) Limit @ 25°C	500 megohm microfarads or 10 GΩ (Rated voltage applied for 120 ±5 seconds @ 25°C)

Regarding Aging Rate: Capacitance measurements (including tolerance) are indexed to a referee time of 1,000 hours.

To obtain IR limit, divide MΩ - μF value by the capacitance and compare to GΩ limit. Select the lower of the two limits.

Capacitance and Dissipation Factor (DF) measured under the following conditions:

1 kHz ±50 Hz and 1.0 ±0.2 Vrms.

Note: When measuring capacitance it is important to ensure the set voltage level is held constant. The HP4284 and Agilent E4980 have a feature known as Automatic Level Control (ALC). The ALC feature should be switched to "ON."

Post Environmental Limits

High Temperature Life, Biased Humidity, Moisture Resistance					
Dielectric	Rated DC Voltage	Capacitance Value	Dissipation Factor (Maximum %)	Capacitance Shift	Insulation Resistance
X8L	> 25	All	3.0	±20%	10% of Initial Limit
	16 / 25		5.0		
	10		7.5		

Table 1 – Capacitance Range/Selection Waterfall (1210 – 2220 Case Sizes)

Capacitance	Cap Code	Case Size / Series			C1210C						C2220C					
		Voltage Code			8	4	3	5	1	A	8	4	3	5	1	A
		Rated Voltage (VDC)			10	16	25	50	100	250	10	16	25	50	100	250
		Capacitance Tolerance			Product Availability and Chip Thickness Codes – See Table 2 for Chip Thickness Dimensions											
Single Chip Stack																
0.47 µF	474		K	M	FV	FV	FV	FV								
1.0 µF	105		K	M	FV	FV	FV	FV								
2.2 µF	225		K	M	FV	FV	FV	FV					JP	JP	JP	
3.3 µF	335		K	M	FV	FV	FV	FV					JP	JP	JP	
4.7 µF	475		K	M	FV	FV	FV						JP	JP	JP	
10 µF	106		K	M									JP	JP	JP	
15 µF	156		K	M									JP	JP	JP	
22 µF	226		K	M									JP	JP	JP	
Double Chip Stack																
1.0 µF	105			M	FW	FW	FW	FW								
2.2 µF	225			M	FW	FW	FW	FW								
3.3 µF	335			M	FW	FW	FW	FW								
4.7 µF	475			M	FW	FW	FW	FW					JR	JR	JR	
10 µF	106			M	FW	FW	FW	FW					JR	JR	JR	
22 µF	226			M									JR	JR	JR	
33 µF	336			M									JR	JR	JR	
47 µF	476			M									JR	JR	JR	
Capacitance	Cap Code	Rated Voltage (VDC)			10	16	25	50	100	250	10	16	25	50	100	250
		Voltage Code			8	4	3	5	1	A	8	4	3	5	1	A
		Case Size / Series			C1210C						C2220C					

These products are protected under US Patent 8,331,078 other patents pending, and any foreign counterparts.

Table 2 – Chip Thickness/Packaging Quantities

Thickness Code	Case Size	Thickness ± Range (mm)	Paper Quantity		Plastic Quantity	
			7" Reel	13" Reel	7" Reel	13" Reel
FV	1210	3.35 ± 0.10	0	0	600	2,000
FW	1210	6.15 ± 0.15	0	0	300	1,000
JP	2220	3.50 ± 0.30	0	0	300	1,300
JR	2220	5.00 ± 0.50	0	0	200	800

Package quantity based on finished chip thickness specifications.

Table 3 – KPS Land Pattern Design Recommendations (mm)

EIA SIZE CODE	METRIC SIZE CODE	Median (Nominal) Land Protrusion				
		C	Y	X	V1	V2
1210	3225	1.50	1.14	1.75	5.05	3.40
2220	5650	2.69	2.08	4.78	7.70	6.00

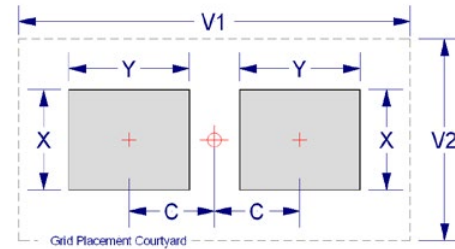

Soldering Process

KEMET's KPS Series devices are compatible with IR reflow techniques. Preheating of these components is recommended to avoid extreme thermal stress. KEMET's recommended profile conditions for IR reflow reflect the profile conditions of the IPC/J-STD-020D standard for moisture sensitivity testing.

To prevent degradation of temperature cycling capability, care must be taken to prevent solder from flowing into the inner side of the lead frames (inner side of "J" lead in contact with the circuit board).

After soldering, the capacitors should be air cooled to room temperature before further processing. Forced air cooling is not recommended.

Hand soldering should be performed with care due to the difficulty in process control. If performed, care should be taken to avoid contact of the soldering iron to the capacitor body. The iron should be used to heat the solder pad, applying solder between the pad and the lead, until reflow occurs. Once reflow occurs, the iron should be removed immediately. (Preheating is required when hand soldering to avoid thermal shock.)

Profile Feature	SnPb Assembly	Pb-Free Assembly
Preheat/Soak		
Temperature Minimum (T_{smin})	100°C	150°C
Temperature Maximum (T_{smax})	150°C	200°C
Time (t_s) from T_{smin} to T_{smax}	60 – 120 seconds	60 – 120 seconds
Ramp-up Rate (T_L to T_p)	3°C/seconds maximum	3°C/seconds maximum
Liquidous Temperature (T_L)	183°C	217°C
Time Above Liquidous (t_L)	60 – 150 seconds	60 – 150 seconds
Peak Temperature (T_p)	235°C	250°C
Time within 5°C of Maximum Peak Temperature (t_p)	20 seconds maximum	10 seconds maximum
Ramp-down Rate (T_p to T_L)	6°C/seconds maximum	6°C/seconds maximum
Time 25°C to Peak Temperature	6 minutes maximum	8 minutes maximum

Note: All temperatures refer to the center of the package, measured on the package body surface that is facing up during assembly reflow.

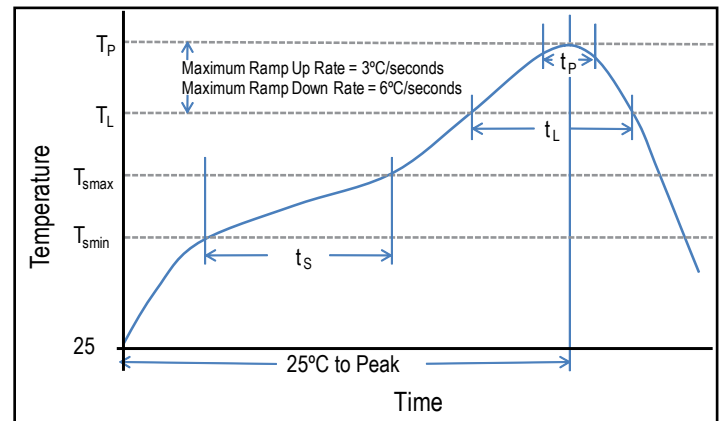

Table 4 – Performance & Reliability: Test Methods and Conditions

Stress	Reference	Test or Inspection Method
Terminal Strength	JIS-C-6429	Appendix 1, Note: Force of 1.8 kg for 60 seconds.
Board Flex	JIS-C-6429	Appendix 2, Note: 5.0 mm minimum
Solderability	J-STD-002	Magnification 50 X. Conditions:
		a) Method B, 4 hours @ 155°C, dry heat @ 235°C
		b) Method B @ 215°C category 3
		c) Method D, category 3 @ 250°C
Temperature Cycling	JESD22 Method JA-104	1,000 cycles (-55°C to +150°C). Measurement at 24 hours +/- 2 hours after test conclusion.
Biased Humidity	MIL-STD-202 Method 103	Load Humidity: 1,000 hours 85°C/85% RH and rated voltage. Add 100 K ohm resistor. Measurement at 24 hours +/- 2 hours after test conclusion.
		Low Volt Humidity: 1,000 hours 85°C/85% RH and 1.5 V. Add 100 K ohm resistor. Measurement at 24 hours +/- 2 hours after test conclusion.
Moisture Resistance	MIL-STD-202 Method 106	t = 24 hours/cycle. Steps 7a and 7b not required. Unpowered. Measurement at 24 hours +/- 2 hours after test conclusion.
Thermal Shock	MIL-STD-202 Method 107	-55°C/+150°C. Note: Number of cycles required- 300, maximum transfer time- 20 seconds, Dwell time- 15 minutes. Air-Air.
High Temperature Life	MIL-STD-202 Method 108	1,000 hours at 150°C with rated voltage applied.
Storage Life	MIL-STD-202 Method 108	150°C, 0 VDC for 1,000 hours.
Vibration	MIL-STD-202 Method 204	5 g's for 20 minutes, 12 cycles each of 3 orientations. Note: Use 8" X 5" PCB .031" thick, 7 secure points on one long side and 2 secure points at corners of opposite sides. Parts mounted within 2" from any secure point. Test from 10 – 2,000 Hz.
Mechanical Shock	MIL-STD-202 Method 213	Figure 1 of Method 213, Condition F.
Resistance to Solvents	MIL-STD-202 Method 215	Add aqueous wash chemical, OKEM Clean or equivalent.

Storage & Handling

Ceramic chip capacitors should be stored in normal working environments. While the chips themselves are quite robust in other environments, solderability will be degraded by exposure to high temperatures, high humidity, corrosive atmospheres, and long term storage. In addition, packaging materials will be degraded by high temperature– reels may soften or warp and tape peel force may increase. KEMET recommends that maximum storage temperature not exceed 40°C and maximum storage humidity not exceed 70% relative humidity. Temperature fluctuations should be minimized to avoid condensation on the parts and atmospheres should be free of chlorine and sulfur bearing compounds. For optimized solderability chip stock should be used promptly, preferably within 1.5 years of receipt.

Construction

Reference	Item	Material
A	Leadframe	Phosphor Bronze – Alloy 510
B	Leadframe Attach	HMP Solder
C	Termination	Cu
D		Ni
E		Sn
F	Inner Electrode	Ni
G	Dielectric Material	BaTiO ₃

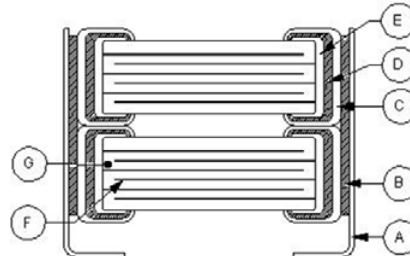

*Note: Image is exaggerated in order to clearly identify all components of construction.
 HMP = High Melting Point*

Product Marking

Laser marking option is not available on:

- COG, Ultra Stable X8R and Y5V dielectric devices
- EIA 0402 case size devices
- EIA 0603 case size devices with Flexible Termination option.
- KPS Commercial and Automotive grade stacked devices.

These capacitors are supplied unmarked only.

Commercial “L” Series, SnPb Termination, C0G Dielectric

10 – 200 VDC (Commercial Grade)

Overview

KEMET’s Commercial “L” Series with Tin/Lead Termination surface mount capacitors in C0G dielectric are designed to meet the needs of critical applications where tin/lead end metallization is required. KEMET’s tin/lead electroplating process is designed to meet a 5% minimum lead content and address concerns for a more robust and reliable lead containing termination system. As the bulk of the electronics industry moves towards RoHS compliance, KEMET continues to provide tin/lead terminated products for military, aerospace and industrial applications and will ensure customers have a stable and long-term source of supply.

KEMET’s C0G dielectric features a 125°C maximum operating temperature and is considered “stable.” The Electronics Components, Assemblies & Materials Association (EIA) characterizes C0G dielectric as a Class I material. Components of this classification are temperature compensating and are suited for resonant circuit applications or those where Q and stability of capacitance characteristics are required. C0G exhibits no change in capacitance with respect to time and voltage and boasts a negligible change in capacitance with reference to ambient temperature. Capacitance change is limited to ± 30 ppm/°C from -55°C to +125°C.

Benefits

- -55°C to +125°C operating temperature range
- Reliable and robust termination system
- EIA 0402, 0603, 0805, 1206, 1210, 1808, 1812, 1825, 2220, and 2225 case sizes
- DC voltage ratings of 10 V, 16 V, 25 V, 50 V, 100 V, and 200 V
- Capacitance offerings ranging from 0.5 pF up to 0.47 μ F
- Available capacitance tolerances of ± 0.10 pF, ± 0.25 pF, ± 0.5 pF, $\pm 1\%$, $\pm 2\%$, $\pm 5\%$, $\pm 10\%$, and $\pm 20\%$

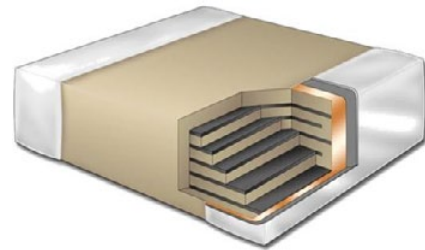

Ordering Information

C	1206	C	104	J	3	G	A	L	TU
Ceramic	Case Size (L" x W")	Specification/ Series	Capacitance Code (pF)	Capacitance Tolerance ¹	Voltage	Dielectric	Failure Rate/ Design	Termination Finish ²	Packaging/Grade (C-Spec) ³
	0402 0603 0805 1206 1210 1808 1812 1825 2220 2225	C = Standard	2 significant digits + number of zeros. Use 9 for 1.0 – 9.9 pF Use 8 for 0.5 – .99 pF e.g., 2.2 pF = 229 e.g., 0.5 pF = 508	B = ± 0.10 pF C = ± 0.25 pF D = ± 0.5 pF F = $\pm 1\%$ G = $\pm 2\%$ J = $\pm 5\%$ K = $\pm 10\%$ M = $\pm 20\%$	8 = 10 V 4 = 16 V 3 = 25 V 5 = 50 V 1 = 100 V 2 = 200 V	G = C0G	A = N/A	L = SnPb (5% minimum)	Blank = Bulk TU = 7" Reel Unmarked

¹ Additional capacitance tolerance offerings may be available. Contact KEMET for details.

² Additional termination finish options may be available. Contact KEMET for details

³ Additional reeling or packaging options may be available. Contact KEMET for details.

Dimensions – Millimeters (Inches)

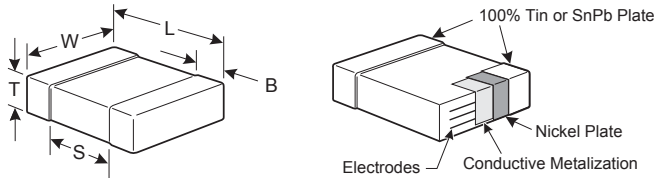

EIA Size Code	Metric Size Code	L Length	W Width	T Thickness	B Bandwidth	S Separation Minimum	Mounting Technique
0402	1005	1.00 (.040) ± 0.05 (.002)	0.50 (.020) ± 0.05 (.002)	See Table 2 for Thickness	0.30 (.012) ± 0.10 (.004)	0.30 (.012)	Solder Reflow Only
0603	1608	1.60 (.063) ± 0.15 (.006)	0.80 (.032) ± 0.15 (.006)		0.35 (.014) ± 0.15 (.006)	0.70 (.028)	Solder Wave or Solder Reflow
0805	2012	2.00 (.079) ± 0.20 (.008)	1.25 (.049) ± 0.20 (.008)		0.50 (.02) ± 0.25 (.010)	0.75 (.030)	
1206	3216	3.20 (.126) ± 0.20 (.008)	1.60 (.063) ± 0.20 (.008)		0.50 (.02) ± 0.25 (.010)	N/A	Solder Reflow Only
1210	3225	3.20 (.126) ± 0.20 (.008)	2.50 (.098) ± 0.20 (.008)		0.50 (.02) ± 0.25 (.010)		
1808	4520	4.70 (.185) ± 0.50 (.020)	2.00 (.079) ± 0.20 (.008)		0.60 (.024) ± 0.35 (.014)		
1812	4532	4.50 (.177) ± 0.30 (.012)	3.20 (.126) ± 0.30 (.012)		0.60 (.024) ± 0.35 (.014)		
1825	4564	4.50 (.177) ± 0.30 (.012)	6.40 (.252) ± 0.40 (.016)		0.60 (.024) ± 0.35 (.014)		
2220	5650	5.70 (.224) ± 0.40 (.016)	5.00 (.197) ± 0.40 (.016)		0.60 (.024) ± 0.35 (.014)		
2225	5664	5.60 (.220) ± 0.40 (.016)	6.40 (.248) ± 0.40 (.016)		0.60 (.024) ± 0.35 (.014)		

Benefits cont'd

- No piezoelectric noise
- Extremely low ESR and ESL
- High thermal stability
- High ripple current capability
- Preferred capacitance solution at line frequencies and into the MHz range
- Negligible capacitance change with respect to temperature from -55°C to +125°C
- No capacitance change with respect to applied rated DC voltage
- No capacitance decay with time
- Non-polar device, minimizing installation concerns
- SnPb plated termination finish (5% minimum)
- Flexible termination option available upon request
- Available for other surface mount products, additional dielectrics and higher voltage ratings upon request

Applications

Typical applications include military, aerospace and other high reliability applications.

Qualification/Certification

Commercial Grade products are subject to internal qualification. Details regarding test methods and conditions are referenced in Table 4, Performance & Reliability.

Environmental Compliance

These devices do not meet RoHS criteria due to the concentration of Pb containment in the termination finish

Electrical Parameters/Characteristics

Item	Parameters/Characteristics
Operating Temperature Range	-55°C to +125°C
Capacitance Change with Reference to +25°C and 0 VDC Applied (TCC)	±30 ppm/°C
Aging Rate (Maximum % Capacitance Loss/Decade Hour)	0%
Dielectric Withstanding Voltage (DWV)	250% of rated voltage (5 ±1 seconds and charge/discharge not exceeding 50 mA)
Dissipation Factor (DF) Maximum Limit @ 25°C	0.1%
Insulation Resistance (IR) Limit @ 25°C	1,000 megohm microfarads or 100 GΩ (Rated voltage applied for 120 ±5 seconds @ 25°C)

To obtain IR limit, divide MΩ-μF value by the capacitance and compare to GΩ limit. Select the lower of the two limits.

Capacitance and dissipation factor (DF) measured under the following conditions:

1 MHz ±100 kHz and 1.0 Vrms ± 0.2 V if capacitance ≤ 1,000 pF

1 kHz ±50 Hz and 1.0 Vrms ± 0.2 V if capacitance > 1,000 pF

Note: When measuring capacitance it is important to ensure the set voltage level is held constant. The HP4284 and Agilent E4980 have a feature known as Automatic Level Control (ALC). The ALC feature should be switched to "ON."

Post Environmental Limits

High Temperature Life, Biased Humidity, Moisture Resistance					
Dielectric	Rated DC Voltage	Capacitance Value	Dissipation Factor (Maximum %)	Capacitance Shift	Insulation Resistance
C0G	All	All	0.5	0.3% or ±0.25 pF	10% of Initial Limit

Table 1A – Capacitance Range/Selection Waterfall (0402 – 1206 Case Sizes)

Capacitance	Cap Code	Case Size / Series	C0402C						C0603C						C0805C						C1206C									
			Voltage Code						Voltage Code						Voltage Code						Voltage Code									
			Rated Voltage (VDC)						Rated Voltage (VDC)						Rated Voltage (VDC)						Rated Voltage (VDC)									
			Capacitance Tolerance						Product Availability and Chip Thickness Codes – See Table 2 for Chip Thickness Dimensions																					
0.50 & 0.75 pF	508 & 758	B	C	D			BB	BB	BB	BB			CB	CB	CB	CB	CB	CB	DC	DC	DC	DC	DC	DC	EB	EB	EB	EB	EB	EB
1.0 - 9.1 pF*	109 - 919*	B	C	D			BB	BB	BB	BB			CB	CB	CB	CB	CB	CB	DC	DC	DC	DC	DC	DC	EB	EB	EB	EB	EB	EB
10 - 20 pF*	100 - 200*				F	G	J	K	M	BB	BB	BB	BB	CB	CB	CB	CB	CB	DC	DC	DC	DC	DC	DC	EB	EB	EB	EB	EB	EB
22 pF	220				F	G	J	K	M	BB	BB	BB	BB	CB	CB	CB	CB	CB	DE	DE	DE	DE	DE	DE	EB	EB	EB	EB	EB	EB
24 - 91 pF*	240 - 910*				F	G	J	K	M	BB	BB	BB	BB	CB	CB	CB	CB	CB	DC	DC	DC	DC	DC	DC	EB	EB	EB	EB	EB	EB
100 pF	101				F	G	J	K	M	BB	BB	BB	BB	CB	CB	CB	CF	CB	CB	DC	DC	DC	DC	DC	EB	EB	EB	EB	EB	EB
110 - 270 pF*	111 - 271*				F	G	J	K	M	BB	BB	BB	BB	CB	CB	CB	CB	CB	DC	DC	DC	DC	DC	DC	EB	EB	EB	EB	EB	EB
300 pF	301				F	G	J	K	M	BB	BB	BB	BB	CB	CB	CB	CB	CB	DC	DC	DC	DC	DC	DC	EB	EB	EB	EB	EB	EB
330 pF	331				F	G	J	K	M	BB	BB	BB	BB	CB	CB	CB	CF	CB	CB	DC	DC	DC	DC	DC	EB	EB	EB	EB	EB	EB
360 pF	361				F	G	J	K	M	BB	BB	BB	BB	CB	CB	CB	CB	CB	DC	DC	DC	DC	DC	DC	EB	EB	EB	EB	EB	EB
390 pF	391				F	G	J	K	M	BB	BB	BB	BB	CB	CB	CB	CB	CB	DC	DC	DC	DC	DC	DC	EB	EB	EB	EB	EB	EB
430 pF	431				F	G	J	K	M	BB	BB	BB	BB	CB	CB	CB	CB	CB	DC	DC	DC	DC	DC	DC	EB	EB	EB	EB	EB	EB
470 pF	471				F	G	J	K	M	BB	BB	BB	BB	CB	CB	CB	CB	CB	DC	DC	DC	DC	DC	DC	EB	EB	EB	EB	EB	EB
510 pF	511				F	G	J	K	M	BB	BB	BB	BB	CB	CB	CB	CB	CB	DC	DC	DC	DC	DC	DC	EB	EB	EB	EB	EB	EB
560 pF	561				F	G	J	K	M	BB	BB	BB	BB	CB	CB	CB	CB	CB	DC	DC	DC	DC	DC	DC	EB	EB	EB	EB	EB	EB
620 pF	621				F	G	J	K	M	BB	BB	BB	BB	CB	CB	CB	CB	CB	DC	DC	DC	DC	DC	DC	EB	EB	EB	EB	EB	EB
680 pF	681				F	G	J	K	M	BB	BB	BB	BB	CB	CB	CB	CB	CB	DC	DC	DC	DC	DC	DC	EB	EB	EB	EB	EB	EB
750 pF	751				F	G	J	K	M	BB	BB	BB	BB	CB	CB	CB	CB	CB	DC	DC	DC	DC	DC	DC	EB	EB	EB	EB	EB	EB
820 pF	821				F	G	J	K	M	BB	BB	BB	BB	CB	CB	CB	CB	CB	DC	DC	DC	DC	DC	DC	EB	EB	EB	EB	EB	EB
910 pF	911				F	G	J	K	M	BB	BB	BB	BB	CB	CB	CB	CB	CB	DC	DC	DC	DC	DC	DC	EB	EB	EB	EB	EB	EB
1,000 pF	102				F	G	J	K	M	BB	BB	BB	BB	CB	CB	CB	CB	CB	DC	DC	DC	DC	DC	DC	EB	EB	EB	EB	EB	EB
1,100 pF	112				F	G	J	K	M	BB	BB	BB	BB	CB	CB	CB	CB	CH	DC	DC	DC	DC	DC	DC	EB	EB	EB	EB	EB	EB
1,200 pF	122				F	G	J	K	M	BB	BB	BB	BB	CB	CB	CB	CB	CH	DC	DC	DC	DC	DC	DC	EB	EB	EB	EB	EB	EB
1,300 pF	132				F	G	J	K	M	BB	BB	BB	BB	CB	CB	CB	CB	CH	DD	DD	DD	DD	DD	DC	EB	EB	EB	EB	EC	EC
1,500 pF	152				F	G	J	K	M	BB	BB	BB	BB	CB	CB	CB	CB	CH	DD	DD	DD	DD	DD	DC	EB	EB	EB	EB	ED	ED
1,600 pF	162				F	G	J	K	M	BB	BB	BB		CB	CB	CB	CB	CH	DD	DD	DD	DD	DD	DC	EB	EB	EB	EB	ED	ED
1,800 pF	182				F	G	J	K	M	BB	BB	BB		CB	CB	CB	CB	CH	DD	DD	DD	DD	DD	DC	EB	EB	EB	EB	ED	ED
2,000 pF	202				F	G	J	K	M	BB	BB	BB		CB	CB	CB	CB	CH	DC	DC	DC	DC	DC	DC	EB	EB	EB	EB	ED	ED
2,200 pF	222				F	G	J	K	M	BB	BB	BB		CB	CB	CB	CB	CH	DC	DC	DC	DC	DC	DC	EB	EB	EB	EB	EE	EE
2,400 pF	242				F	G	J	K	M	BB	BB	BB		CB	CB	CB	CB	CH	DC	DC	DC	DC	DC	DC	EB	EB	EB	EB	EE	EE
2,700 pF	272				F	G	J	K	M					CB	CB	CB	CB		DC	DC	DC	DC	DC	DC	EB	EB	EB	EB	EC	EC
3,000 pF	302				F	G	J	K	M					CB	CB	CB	CB		DD	DD	DD	DD	DC	DC	EC	EC	EC	EC	EC	EC
3,300 pF	332				F	G	J	K	M					CB	CB	CB	CB		DD	DD	DD	DD	DC	DC	EC	EC	EC	EC	EE	EE
3,600 pF	362				F	G	J	K	M					CB	CB	CB	CB		DD	DD	DD	DD	DC	DC	EC	EC	EC	EC	EE	EE
3,900 pF	392				F	G	J	K	M					CB	CB	CB	CB		DE	DE	DE	DE	DC	DC	EC	EC	EC	EC	EF	EF
4,300 pF	432				F	G	J	K	M					CB	CB	CB	CB		DE	DE	DE	DE	DC	DC	EC	EC	EC	EC	EC	EB
4,700 pF	472				F	G	J	K	M					CB	CB	CB	CB	CB	DE	DE	DE	DE	DC	DC	EC	EC	EC	EC	EC	EB
5,100 pF	512				F	G	J	K	M					CB	CB	CB	CB		DE	DE	DE	DE	DC	DC	ED	ED	ED	ED	ED	EB
5,600 pF	562				F	G	J	K	M					CB	CB	CB	CB		DC	DC	DC	DC	DC	DC	ED	ED	ED	ED	ED	EB
6,200 pF	622				F	G	J	K	M					CB	CB	CB	CB		DC	DC	DC	DC	DC	DG	EB	EB	EB	EB	EB	EB
6,800 pF	682				F	G	J	K	M					CB	CB	CB	CB		DC	DC	DC	DC	DC	DG	EB	EB	EB	EB	EB	EB
7,500 pF	752				F	G	J	K	M					CB	CB	CB			DC	DC	DC	DC	DC	DG	EB	EB	EB	EB	EB	EB
8,200 pF	822				F	G	J	K	M					CB	CB	CB			DC	DC	DC	DC	DC	DG	EC	EC	EC	EC	EB	EB
9,100 pF	912				F	G	J	K	M					CB	CB	CB			DC	DC	DC	DC	DC	DG	EC	EC	EC	EC	EB	EB
10,000 pF	103				F	G	J	K	M					CB	CB	CB			DC	DC	DC	DC	DC	DD	ED	ED	ED	ED	EB	EB
12,000 pF	123				F	G	J	K	M					CB	CB	CB			DC	DC	DC	DC	DE		EB	EB	EB	EB	EB	ED
15,000 pF	153				F	G	J	K	M					CB	CB	CB			DC	DC	DC	DD	DG		EB	EB	EB	EB	EB	EF
18,000 pF	183				F	G	J	K	M										DC	DC	DC	DD			EB	EB	EB	EB	EB	EH
22,000 pF	223				F	G	J	K	M										DD	DD	DD	DF			EB	EB	EB	EB	EC	EH
27,000 pF	273				F	G	J	K	M										DF	DF	DF				EB	EB	EB	EB	EE	
33,000 pF	333				F	G	J	K	M										DG	DG	DG				EB	EB	EB	EB	EE	

*Capacitance range Includes E24 decade values only. (i.e., 10, 11, 12, 13, 15, 16, 18, 20, 22, 24, 27, 30, 33, 36, 39, 43, 47, 51, 56, 62, 68, 75, 82 and 91)
 KEMET reserves the right to substitute product with an improved temperature characteristic, tighter capacitance tolerance and/or higher voltage capability within the same form factor (configuration and dimensions).
 These products are protected under US Patents 7,172,985 and 7,670,981, other patents pending, and any foreign counterparts.

Table 1B – Capacitance Range/Selection Waterfall (1210 – 2225 Case Sizes)

Capacitance	Cap Code	Case Size / Series			C1210C						C1808C			C1812C			C1825C			C2220C			C2225C					
		Voltage Code			8	4	3	5	1	2	5	1	2	5	1	2	5	1	2	3	1	2	5	1	2			
		Rated Voltage (VDC)			10	16	25	50	100	200	50	100	200	50	100	200	50	100	200	50	100	200	50	100	200			
Capacitance Tolerance		Product Availability and Chip Thickness Codes See Table 2 for Chip Thickness Dimensions																										
5,100 pF	512		F	G	J	K	M	FB	FB	FB	FB	FG	FG				GB	GB	GH	HB	HB	HB				KE	KE	KE
5,600 pF	562		F	G	J	K	M	FB	FB	FB	FB	FG	FG				GB	GB	GH	HB	HB	HB				KE	KE	KE
6,200 pF	622		F	G	J	K	M	FB	FB	FB	FB	FG	FB				GB	GB	GJ	HB	HB	HB	JE	JE	JB	KE	KE	KE
6,800 pF	682		F	G	J	K	M	FB	FB	FB	FB	FG	FB				GB	GB	GJ	HB	HB	HB	JE	JE	JB	KE	KE	KE
7,500 pF	752		F	G	J	K	M	FC	FC	FC	FC	FC	FB							HB	HB	HB	JE	JE	JB	KE	KE	KE
8,200 pF	822		F	G	J	K	M	FC	FC	FC	FC	FC	FB				GB	GH	GB	HB	HB	HB	JE	JE	JB	KE	KE	KE
9,100 pF	912		F	G	J	K	M	FE	FE	FE	FE	FE	FB							HB	HB	HB	JE	JE	JB	KE	KE	KE
10,000 pF	103		F	G	J	K	M	FF	FF	FF	FF	FF	FB				GB	GH	GB	HB	HB	HE	JE	JE	JB	KE	KE	KE
12,000 pF	123		F	G	J	K	M	FG	FG	FG	FG	FB	FB				GB	GG	GB	HB	HB	HE	JE	JE	JB	KE	KE	KE
15,000 pF	153		F	G	J	K	M	FG	FG	FG	FG	FB	FC				GB	GB	GB	HB	HB		JE	JE	JB	KE	KE	KE
18,000 pF	183		F	G	J	K	M	FB	FB	FB	FB	FB	FC				GB	GB	GB	HB	HE		JE	JE	JB	KE	KE	KE
22,000 pF	223		F	G	J	K	M	FB	FB	FB	FB	FB	FF				GB	GB	GB	HB	HE		JE	JB	JB	KE	KE	
27,000 pF	273		F	G	J	K	M	FB	FB	FB	FB	FB	FG				GB	GB	GB	HB	HG		JE	JB	JB	KE	KE	
33,000 pF	333		F	G	J	K	M	FB	FB	FB	FB	FB	FH				GB	GB	GB				JB	JB	JB	KE		
39,000 pF	393		F	G	J	K	M	FB	FB	FB	FB	FE	FH				GB	GB	GB				JB	JB	JB			
47,000 pF	473		F	G	J	K	M	FB	FB	FB	FB	FE	FJ				GB	GB	GD				JB	JB	JB			
56,000 pF	563		F	G	J	K	M	FB	FB	FB	FB	FF					GB	GB	GD				JB	JB	JB			
68,000 pF	683		F	G	J	K	M	FB	FB	FB	FC	FG					GB	GB	GK				JB	JB	JB			
82,000 pF	823		F	G	J	K	M	FC	FC	FC	FF	FH					GB	GB	GM				JB	JB	JB			
0.10 µF	104		F	G	J	K	M	FE	FE	FE	FG	FM					GB	GD	GM				JB	JB	JD			
0.12 µF	124		F	G	J	K	M	FG	FG	FG	FH						GB	GH					JB	JB	JD			
0.15 µF	154		F	G	J	K	M	FH	FH	FH	FM						GD	GN					JB	JB	JG			
0.18 µF	184		F	G	J	K	M	FJ	FJ	FJ							GH						JB	JD	JG			
0.22 µF	224		F	G	J	K	M	FK	FK	FK							GK						JB	JD	JL			
0.27 µF	274		F	G	J	K	M																JB	JF				
0.33 µF	334		F	G	J	K	M																JD	JG				
0.39 µF	394		F	G	J	K	M																JG					
0.47 µF	474		F	G	J	K	M																JG					
Capacitance	Cap Code	Rated Voltage (VDC)			10	16	25	50	100	200	50	100	200	50	100	200	50	100	200	50	100	200	50	100	200			
		Voltage Code			8	4	3	5	1	2	5	1	2	5	1	2	5	1	2	3	1	2	5	1	2			
		Case Size / Series			C1210C						C1808C			C1812C			C1825C			C2220C			C2225C					

*Capacitance range Includes E24 decade values only. (i.e., 10, 11, 12, 13, 15, 16, 18, 20, 22, 24, 27, 30, 33, 36, 39, 43, 47, 51, 56, 62, 68, 75, 82 and 91)
 KEMET reserves the right to substitute product with an improved temperature characteristic, tighter capacitance tolerance and/or higher voltage capability within the same form factor (configuration and dimensions).
 These products are protected under US Patents 7,172,985 and 7,670,981, other patents pending, and any foreign counterparts.

Table 2 – Chip Thickness/Packaging Quantities

Thickness Code	Case Size	Thickness ± Range (mm)	Paper Quantity		Plastic Quantity	
			7" Reel	13" Reel	7" Reel	13" Reel
BB	0402	0.50 ± 0.05	10,000	50,000	0	0
BD	0402	0.55 ± 0.05	10,000	50,000	0	0
CB	0603	0.80 ± 0.07	4,000	10,000	0	0
CF	0603	0.80 ± 0.07	4,000	15,000	0	0
CH	0603	0.85 ± 0.07	4,000	10,000	0	0
DE	0805	0.70 ± 0.20	4,000	10,000	0	0
DC	0805	0.78 ± 0.10	4,000	10,000	0	0
DD	0805	0.90 ± 0.10	4,000	10,000	0	0
DF	0805	1.10 ± 0.10	0	0	2,500	10,000
DG	0805	1.25 ± 0.15	0	0	2,500	10,000
EB	1206	0.78 ± 0.10	4,000	10,000	4,000	10,000
EC	1206	0.90 ± 0.10	0	0	4,000	10,000
ED	1206	1.00 ± 0.10	0	0	2,500	10,000
EE	1206	1.10 ± 0.10	0	0	2,500	10,000
EF	1206	1.20 ± 0.15	0	0	2,500	10,000
EH	1206	1.60 ± 0.20	0	0	2,000	8,000
FB	1210	0.78 ± 0.10	0	0	4,000	10,000
FC	1210	0.90 ± 0.10	0	0	4,000	10,000
FE	1210	1.00 ± 0.10	0	0	2,500	10,000
FF	1210	1.10 ± 0.10	0	0	2,500	10,000
FG	1210	1.25 ± 0.15	0	0	2,500	10,000
FH	1210	1.55 ± 0.15	0	0	2,000	8,000
FM	1210	1.70 ± 0.20	0	0	2,000	8,000
FJ	1210	1.85 ± 0.20	0	0	2,000	8,000
FK	1210	2.10 ± 0.20	0	0	2,000	8,000
LF	1808	1.00 ± 0.15	0	0	2,500	10,000
GB	1812	1.00 ± 0.10	0	0	1,000	4,000
GD	1812	1.25 ± 0.15	0	0	1,000	4,000
GH	1812	1.40 ± 0.15	0	0	1,000	4,000
GG	1812	1.55 ± 0.10	0	0	1,000	4,000
GK	1812	1.60 ± 0.20	0	0	1,000	4,000
GJ	1812	1.70 ± 0.15	0	0	1,000	4,000
GN	1812	1.70 ± 0.20	0	0	1,000	4,000
GM	1812	2.00 ± 0.20	0	0	500	2,000
HB	1825	1.10 ± 0.15	0	0	1,000	4,000
HE	1825	1.40 ± 0.15	0	0	1,000	4,000
HG	1825	1.60 ± 0.20	0	0	1,000	4,000
JB	2220	1.00 ± 0.15	0	0	1,000	4,000
JD	2220	1.30 ± 0.15	0	0	1,000	4,000
JE	2220	1.40 ± 0.15	0	0	1,000	4,000
JF	2220	1.50 ± 0.15	0	0	1,000	4,000
JG	2220	1.70 ± 0.15	0	0	1,000	4,000
JL	2220	2.00 ± 0.20	0	0	500	2,000
KE	2225	1.40 ± 0.15	0	0	1,000	4,000
Thickness Code	Case Size	Thickness ± Range (mm)	7" Reel	13" Reel	7" Reel	13" Reel
			Paper Quantity		Plastic Quantity	

Package quantity based on finished chip thickness specifications.

Table 3 – Chip Capacitor Land Pattern Design Recommendations per IPC–7351

EIA Size Code	Metric Size Code	Density Level A: Maximum (Most) Land Protrusion (mm)					Density Level B: Median (Nominal) Land Protrusion (mm)					Density Level C: Minimum (Least) Land Protrusion (mm)				
		C	Y	X	V1	V2	C	Y	X	V1	V2	C	Y	X	V1	V2
0402	1005	0.50	0.72	0.72	2.20	1.20	0.45	0.62	0.62	1.90	1.00	0.40	0.52	0.52	1.60	0.80
0603	1608	0.90	1.15	1.10	4.00	2.10	0.80	0.95	1.00	3.10	1.50	0.60	0.75	0.90	2.40	1.20
0805	2012	1.00	1.35	1.55	4.40	2.60	0.90	1.15	1.45	3.50	2.00	0.75	0.95	1.35	2.80	1.70
1206	3216	1.60	1.35	1.90	5.60	2.90	1.50	1.15	1.80	4.70	2.30	1.40	0.95	1.70	4.00	2.00
1210	3225	1.60	1.35	2.80	5.65	3.80	1.50	1.15	2.70	4.70	3.20	1.40	0.95	2.60	4.00	2.90
1210 ¹	3225	1.50	1.60	2.90	5.60	3.90	1.40	1.40	2.80	4.70	3.30	1.30	1.20	2.70	4.00	3.00
1808	4520	2.30	1.75	2.30	7.40	3.30	2.20	1.55	2.20	6.50	2.70	2.10	1.35	2.10	5.80	2.40
1812	4532	2.15	1.60	3.60	6.90	4.60	2.05	1.40	3.50	6.00	4.00	1.95	1.20	3.40	5.30	3.70
1825	4564	2.15	1.60	6.90	6.90	7.90	2.05	1.40	6.80	6.00	7.30	1.95	1.20	6.70	5.30	7.00
2220	5650	2.75	1.70	5.50	8.20	6.50	2.65	1.50	5.40	7.30	5.90	2.55	1.30	5.30	6.60	5.60
2225	5664	2.70	1.70	6.90	8.10	7.90	2.60	1.50	6.80	7.20	7.30	2.50	1.30	6.70	6.50	7.00

¹ Only for capacitance values $\geq 22 \mu\text{F}$

Density Level A: For low-density product applications. Recommended for wave solder applications and provides a wider process window for reflow solder processes. KEMET only recommends wave soldering of EIA 0603, 0805 and 1206 case sizes.

Density Level B: For products with a moderate level of component density. Provides a robust solder attachment condition for reflow solder processes.

Density Level C: For high component density product applications. Before adapting the minimum land pattern variations the user should perform qualification testing based on the conditions outlined in IPC Standard 7351 (IPC–7351).

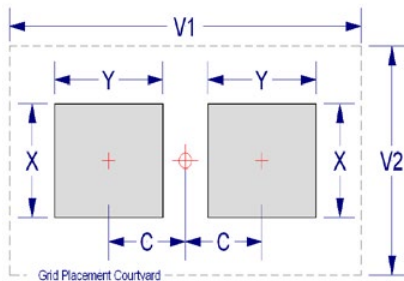

Soldering Process

Recommended Soldering Technique:

- Solder wave or solder reflow for EIA case sizes 0603, 0805 and 1206
- All other EIA case sizes are limited to solder reflow only

Recommended Soldering Profile:

- KEMET recommends following the guidelines outlined in IPC/JEDEC J–STD–020

Table 4 – Performance & Reliability: Test Methods and Conditions

Stress	Reference	Test or Inspection Method
Terminal Strength	JIS-C-6429	Appendix 1, Note: Force of 1.8 kg for 60 seconds.
Board Flex	JIS-C-6429	Appendix 2, Note: Standard termination system – 2.0 mm (minimum) for all except 3 mm for COG. Flexible termination system – 3.0 mm (minimum).
Solderability	J-STD-002	Magnification 50 X. Conditions:
		a) Method B, 4 hours @ 155°C, dry heat @ 235°C
		b) Method B @ 215°C category 3
		c) Method D, category 3 @ 260°C
Temperature Cycling	JESD22 Method JA-104	1,000 Cycles (-55°C to +125°C). Measurement at 24 hours +/- 2 hours after test conclusion.
Biased Humidity	MIL-STD-202 Method 103	Load Humidity: 1,000 hours 85°C/85% RH and rated voltage. Add 100 K ohm resistor. Measurement at 24 hours +/- 2 hours after test conclusion.
		Low Volt Humidity: 1,000 hours 85°C/85% RH and 1.5 V. Add 100 K ohm resistor. Measurement at 24 hours +/- 2 hours after test conclusion.
Moisture Resistance	MIL-STD-202 Method 106	t = 24 hours/cycle. Steps 7a and 7b not required. Unpowered. Measurement at 24 hours +/- 2 hours after test conclusion.
Thermal Shock	MIL-STD-202 Method 107	-55°C/+125°C. Note: Number of cycles required – 300, maximum transfer time – 20 seconds, dwell time – 15 minutes. Air – Air.
High Temperature Life	MIL-STD-202 Method 108 /EIA-198	1,000 hours at 125°C (85°C for X5R, Z5U and Y5V) with 2 X rated voltage applied.
Storage Life	MIL-STD-202 Method 108	150°C, 0 VDC for 1,000 hours.
Vibration	MIL-STD-202 Method 204	5 g's for 20 min., 12 cycles each of 3 orientations. Note: Use 8" X 5" PCB 0.031" thick 7 secure points on one long side and 2 secure points at corners of opposite sides. Parts mounted within 2" from any secure point. Test from 10 – 2,000 Hz
Mechanical Shock	MIL-STD-202 Method 213	Figure 1 of Method 213, Condition F.
Resistance to Solvents	MIL-STD-202 Method 215	Add aqueous wash chemical, OKEM Clean or equivalent.

Storage and Handling

Ceramic chip capacitors should be stored in normal working environments. While the chips themselves are quite robust in other environments, solderability will be degraded by exposure to high temperatures, high humidity, corrosive atmospheres, and long term storage. In addition, packaging materials will be degraded by high temperature— reels may soften or warp and tape peel force may increase. KEMET recommends that maximum storage temperature not exceed 40°C and maximum storage humidity not exceed 70% relative humidity. Temperature fluctuations should be minimized to avoid condensation on the parts and atmospheres should be free of chlorine and sulfur bearing compounds. For optimized solderability chip stock should be used promptly, preferably within 1.5 years of receipt.

Construction

Reference	Item	Material
A	Termination System	Finish
B		Barrier Layer
C		Base Metal
D	Inner Electrode	Ni
E	Dielectric Material	CaZrO ₃

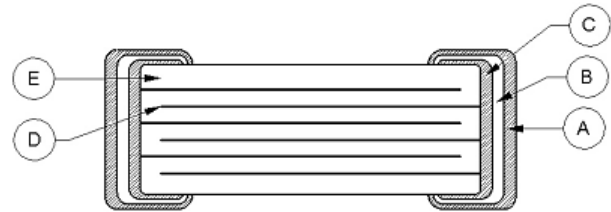

Note: Image is exaggerated in order to clearly identify all components of construction.

Capacitor Marking (Optional):

Laser marking option is not available on:

- COG, Ultra Stable X8R and Y5V dielectric devices
- EIA 0402 case size devices
- EIA 0603 case size devices with Flexible Termination option.
- KPS Commercial and Automotive grade stacked devices.

These capacitors are supplied unmarked only.

Commercial “L” Series, SnPb Termination, X7R Dielectric

6.3V – 250 VDC (Commercial Grade)

Overview

KEMET’s Commercial “L” Series with Tin/Lead Termination surface mount capacitors in X7R dielectric are designed to meet the needs of critical applications where tin/lead end metallization is required. KEMET’s tin/lead electroplating process is designed to meet a 5% minimum lead content and address concerns for a more robust and reliable lead containing termination system. As the bulk of the electronics industry moves towards RoHS compliance, KEMET continues to provide tin/lead terminated products for military, aerospace and industrial applications and will ensure customers have a stable and long-term source of supply.

KEMET’s X7R dielectric features a 125°C maximum operating temperature and is considered “temperature stable.” The Electronics Components, Assemblies & Materials Association (EIA) characterizes X7R dielectric as a Class II material. Components of this classification are fixed, ceramic dielectric capacitors suited for bypass and decoupling applications or for frequency discriminating circuits where Q and stability of capacitance characteristics are not critical. X7R exhibits a predictable change in capacitance with respect to time and voltage and boasts a minimal change in capacitance with reference to ambient temperature. Capacitance change is limited to $\pm 15\%$ from -55°C to +125°C.

Benefits

- -55°C to +125°C operating temperature range
- Temperature stable dielectric
- Reliable and robust termination system
- EIA 0402, 0603, 0805, 1206, 1210, 1808, 1812, 1825, 2220, and 2225 case sizes
- DC voltage ratings of 6.3 V, 10 V, 16 V, 25 V, 50 V, 100 V, 200 V, and 250 V
- Capacitance offerings ranging from 10 pF to 22 μ F
- Available capacitance tolerances of $\pm 5\%$, $\pm 10\%$, and $\pm 20\%$

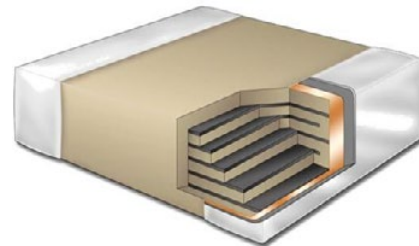

Ordering Information

C	1206	C	226	K	8	R	A	C	TU
Ceramic	Case Size (L" x W")	Specification/ Series	Capacitance Code (pF)	Capacitance Tolerance	Voltage	Dielectric	Failure Rate/ Design	Termination Finish ¹	Packaging/Grade (C-Spec) ²
	0402 0603 0805 1206 1210 1808 1812 1825 2220 2225	C = Standard	2 Significant Digits + Number of Zeros	J = $\pm 5\%$ K = $\pm 10\%$ M = $\pm 20\%$	9 = 6.3 V 8 = 10 V 4 = 16 V 3 = 25 V 6 = 35 V 5 = 50 V 1 = 100 V 2 = 200 V A = 250 V	R = X7R	A = N/A	L = SnPb (5% minimum)	Blank = Bulk TU = 7" Reel Unmarked TM = 7" Reel Marked

¹ Additional termination finish options may be available. Contact KEMET for details

² Additional reeling or packaging options may be available. Contact KEMET for details.

Dimensions – Millimeters (Inches)

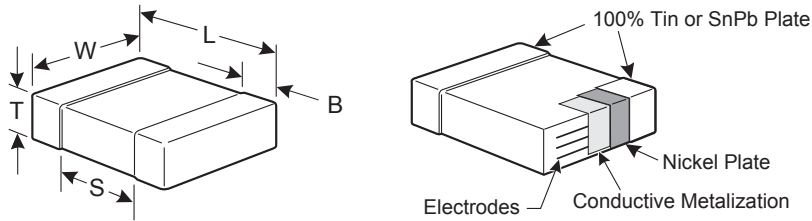

EIA Size Code	Metric Size Code	L Length	W Width	T Thickness	B Bandwidth	S Separation Minimum	Mounting Technique
0402	1005	1.00 (.040) ± 0.05 (.002)	0.50 (.020) ± 0.05 (.002)	See Table 2 for Thickness	0.30 (.012) ± 0.10 (.004)	0.30 (.012)	Solder Reflow Only
0603	1608	1.60 (.063) ± 0.15 (.006)	0.80 (.032) ± 0.15 (.006)		0.35 (.014) ± 0.15 (.006)	0.70 (.028)	Solder Wave or Solder Reflow
0805	2012	2.00 (.079) ± 0.20 (.008)	1.25 (.049) ± 0.20 (.008)		0.50 (0.02) ± 0.25 (.010)	0.75 (.030)	
1206	3216	3.20 (.126) ± 0.20 (.008)	1.60 (.063) ± 0.20 (.008)		0.50 (0.02) ± 0.25 (.010)	N/A	Solder Reflow Only
1210 ¹	3225	3.20 (.126) ± 0.20 (.008)	2.50 (.098) ± 0.20 (.008)		0.50 (0.02) ± 0.25 (.010)		
1808	4520	4.70 (.185) ± 0.50 (.020)	2.00 (.079) ± 0.20 (.008)		0.60 (.024) ± 0.35 (.014)		
1812	4532	4.50 (.177) ± 0.30 (.012)	3.20 (.126) ± 0.30 (.012)		0.60 (.024) ± 0.35 (.014)		
1825	4564	4.50 (.177) ± 0.30 (.012)	6.40 (.252) ± 0.40 (.016)		0.60 (.024) ± 0.35 (.014)		
2220	5650	5.70 (.224) ± 0.40 (.016)	5.00 (.197) ± 0.40 (.016)		0.60 (.024) ± 0.35 (.014)		
2225	5664	5.60 (.220) ± 0.40 (.016)	6.40 (.248) ± 0.40 (.016)		0.60 (.024) ± 0.35 (.014)		

¹ For capacitance values ≥ 12 μF add 0.02 (0.001) to the width tolerance dimension

Benefits cont'd

- Non-polar device, minimizing installation concerns
- SnPb plated termination finish (5% minimum)
- Flexible termination option available upon request
- Available for other surface mount products, additional dielectrics and higher voltage ratings upon request

Applications

Typical applications include military, aerospace and other high reliability applications.

Qualification/Certification

Commercial Grade products are subject to internal qualification. Details regarding test methods and conditions are referenced in Table 4, Performance & Reliability.

Environmental Compliance

These devices do not meet RoHS criteria due to the concentration of Pb containment in the termination finish

Electrical Parameters/Characteristics

Item	Parameters/Characteristics
Operating Temperature Range	-55°C to +125°C
Capacitance Change with Reference to +25°C and 0 VDC Applied (TCC)	±15%
Aging Rate (Maximum % Capacitance Loss/Decade Hour)	3.0%
Dielectric Withstanding Voltage (DWV)	250% of rated voltage (5 ±1 seconds and charge/discharge not exceeding 50 mA)
Dissipation Factor (DF) Maximum Limit @ 25°C	5% (6.3 and 10 V), 3.5% (16 and 25 V) and 2.5% (50 to 250 V)
Insulation Resistance (IR) Limit @ 25°C	See Insulation Resistance Limit Table (Rated voltage applied for 120 ±5 seconds @ 25°C)

Regarding aging rate: Capacitance measurements (including tolerance) are indexed to a referee time of 1,000 hours.

To obtain IR limit, divide $M\Omega\text{-}\mu F$ value by the capacitance and compare to $G\Omega$ limit. Select the lower of the two limits.

Capacitance and dissipation factor (DF) measured under the following conditions:

1 kHz ±50 Hz and 1.0 ±0.2 Vrms if capacitance ≤ 10 μF

120 Hz ±10 Hz and 0.5 ±0.1 Vrms if capacitance > 10 μF

Note: When measuring capacitance it is important to ensure the set voltage level is held constant. The HP4284 and Agilent E4980 have a feature known as Automatic Level Control (ALC). The ALC feature should be switched to "ON."

Post Environmental Limits

High Temperature Life, Biased Humidity, Moisture Resistance					
Dielectric	Rated DC Voltage	Capacitance Value	Dissipation Factor (Maximum %)	Capacitance Shift	Insulation Resistance
X7R	> 25	All	3.0	±20%	10% of Initial Limit
	16/25		5.0		
	< 16		7.5		

Insulation Resistance Limit Table (X7R Dielectric)

EIA Case Size	1,000 Megohm Microfarads or 100 GΩ	500 Megohm Microfarads or 10 GΩ
0201	N/A	ALL
0402	< 0.012 μF	≥ 0.012 μF
0603	< 0.047 μF	≥ 0.047 μF
0805	< 0.047 μF	≥ 0.047 μF
1206	< 0.22 μF	≥ 0.22 μF
1210	< 0.39 μF	≥ 0.39 μF
1808	ALL	N/A
1812	< 2.2 μF	≥ 2.2 μF
1825	ALL	N/A
2220	< 10 μF	≥ 10 μF
2225	ALL	N/A

Table 1A – Capacitance Range/Selection Waterfall (0402 – 1206 Case Sizes)

Capacitance	Cap Code	Case Size / Series		C0402C					C0603C						C0805C							C1206C																	
		Voltage Code		9	8	4	3	5	9	8	4	3	5	1	2	9	8	4	3	6	5	1	2	A	9	8	4	3	6	5	1	2	A						
				Rated Voltage (VDC)	6.3	10	16	25	50	6.3	10	16	25	50	100	200	6.3	10	16	25	35	50	100	200	250	6.3	10	16	25	35	50	100	200	250					
		Capacitance Tolerance	Product Availability and Chip Thickness Codes – See Table 2 for Chip Thickness Dimensions																																				
10 - 91 pF*	100 - 910*	J	K	M	BB	BB	BB	BB	BB	CB	CB	CB	CB	CB	CB	CB	DC	DC	DC	DC	DC	DC	DC	DC	DC	DC	DC	DC	DC	DC	EB	EB	EB	EB	EB	EB	EB	EB	EB
100 - 150 pF**	101 - 151**	J	K	M	BB	BB	BB	BB	BB	CB	CB	CB	CB	CB	CB	CB	DC	DC	DC	DC	DC	DC	DC	DC	DC	DC	DC	DC	DC	DC	EB	EB	EB	EB	EB	EB	EB	EB	EB
180 - 820 pF**	181 - 821**	J	K	M	BB	BB	BB	BB	BB	CB	CB	CB	CB	CB	CB	CB	DC	DC	DC	DC	DC	DC	DC	DC	DC	DC	DC	DC	DC	DC	EB	EB	EB	EB	EB	EB	EB	EB	EB
1000 pF	102	J	K	M	BB	BB	BB	BB	BB	CB	CB	CB	CB	CB	CB	CB	DC	DC	DC	DC	DC	DC	DC	DC	DC	DC	DC	DC	DC	DC	EB	EB	EB	EB	EB	EB	EB	EB	EB
1200 pF	122	J	K	M	BB	BB	BB	BB	BB	CB	CB	CB	CB	CB	CB	CB	DC	DC	DC	DC	DC	DC	DC	DC	DC	DC	DC	DC	DC	DC	EB	EB	EB	EB	EB	EB	EB	EB	EB
1500 pF	152	J	K	M	BB	BB	BB	BB	BB	CB	CB	CB	CB	CB	CB	CB	DC	DC	DC	DC	DC	DC	DC	DC	DC	DC	DC	DC	DC	DC	EB	EB	EB	EB	EB	EB	EB	EB	EB
1800 pF	182	J	K	M	BB	BB	BB	BB	BB	CB	CB	CB	CB	CB	CB	CB	DC	DC	DC	DC	DC	DC	DC	DC	DC	DC	DC	DC	DC	DC	EB	EB	EB	EB	EB	EB	EB	EB	EB
2200 pF	222	J	K	M	BB	BB	BB	BB	BB	CB	CB	CB	CB	CB	CB	CB	DC	DC	DC	DC	DC	DC	DC	DC	DC	DC	DC	DC	DC	DC	EB	EB	EB	EB	EB	EB	EB	EB	EB
2700 pF	272	J	K	M	BB	BB	BB	BB	BB	CB	CB	CB	CB	CB	CB	CB	DC	DC	DC	DC	DC	DC	DC	DC	DC	DC	DC	DC	DC	DC	EB	EB	EB	EB	EB	EB	EB	EB	EB
3300 pF	332	J	K	M	BB	BB	BB	BB	BB	CB	CB	CB	CB	CB	CB	CB	DC	DC	DC	DC	DC	DC	DC	DC	DC	DC	DC	DC	DC	DC	EB	EB	EB	EB	EB	EB	EB	EB	EB
3900 pF	392	J	K	M	BB	BB	BB	BB	BB	CB	CB	CB	CB	CB	CB	CB	DC	DC	DC	DC	DC	DC	DC	DC	DC	DC	DC	DC	DC	DC	EB	EB	EB	EB	EB	EB	EB	EB	EB
4700 pF	472	J	K	M	BB	BB	BB	BB	BB	CB	CB	CB	CB	CB	CB	CB	DC	DC	DC	DC	DC	DC	DC	DC	DC	DC	DC	DC	DC	DC	EB	EB	EB	EB	EB	EB	EB	EB	EB
5600 pF	562	J	K	M	BB	BB	BB	BB	BB	CB	CB	CB	CB	CB	CB	CB	DC	DC	DC	DC	DC	DC	DC	DC	DC	DC	DC	DC	DC	DC	EB	EB	EB	EB	EB	EB	EB	EB	EB
6800 pF	682	J	K	M	BB	BB	BB	BB	BB	CB	CB	CB	CB	CB	CB	CB	DC	DC	DC	DC	DC	DC	DC	DC	DC	DC	DC	DC	DC	DC	EB	EB	EB	EB	EB	EB	EB	EB	EB
8200 pF	822	J	K	M	BB	BB	BB	BB	BB	CB	CB	CB	CB	CB	CB	CB	DC	DC	DC	DC	DC	DC	DC	DC	DC	DC	DC	DC	DC	DC	EB	EB	EB	EB	EB	EB	EB	EB	EB
10000 pF	103	J	K	M	BB	BB	BB	BB	BB	CB	CB	CB	CB	CB	CB	CB	DC	DC	DC	DC	DC	DC	DC	DC	DC	DC	DC	DC	DC	DC	EB	EB	EB	EB	EB	EB	EB	EB	EB
12000 pF	123	J	K	M	BB	BB	BB	BB	BB	CB	CB	CB	CB	CB	CB	CB	DC	DC	DC	DC	DC	DC	DC	DC	DC	DC	DC	DC	DC	DC	EB	EB	EB	EB	EB	EB	EB	EB	EB
15000 pF	153	J	K	M	BB	BB	BB	BB	BB	CB	CB	CB	CB	CB	CB	CB	DC	DC	DC	DC	DC	DC	DC	DC	DC	DC	DC	DC	DC	DC	EB	EB	EB	EB	EB	EB	EB	EB	EB
18000 pF	183	J	K	M	BB	BB	BB	BB	BB	CB	CB	CB	CB	CB	CB	CB	DC	DC	DC	DC	DC	DC	DC	DC	DC	DC	DC	DC	DC	DC	EB	EB	EB	EB	EB	EB	EB	EB	EB
22000 pF	223	J	K	M	BB	BB	BB	BB	BB	CB	CB	CB	CB	CB	CB	CB	DC	DC	DC	DC	DC	DC	DC	DC	DC	DC	DC	DC	DC	DC	EB	EB	EB	EB	EB	EB	EB	EB	EB
27000 pF	273	J	K	M	BB	BB	BB	BB	BB	CB	CB	CB	CB	CB	CB	CB	DC	DC	DC	DC	DC	DC	DC	DC	DC	DC	DC	DC	DC	DC	EB	EB	EB	EB	EB	EB	EB	EB	EB
33000 pF	333	J	K	M	BB	BB	BB	BB	BB	CB	CB	CB	CB	CB	CB	CB	DC	DC	DC	DC	DC	DC	DC	DC	DC	DC	DC	DC	DC	DC	EB	EB	EB	EB	EB	EB	EB	EB	EB
39000 pF	393	J	K	M	BB	BB	BB	BB	BB	CB	CB	CB	CB	CB	CB	CB	DC	DC	DC	DC	DC	DC	DC	DC	DC	DC	DC	DC	DC	DC	EB	EB	EB	EB	EB	EB	EB	EB	EB
47000 pF	473	J	K	M	BB	BB	BB	BB	BB	CB	CB	CB	CB	CB	CB	CB	DC	DC	DC	DC	DC	DC	DC	DC	DC	DC	DC	DC	DC	DC	EB	EB	EB	EB	EB	EB	EB	EB	EB
56000 pF	563	J	K	M	BB	BB	BB	BB	BB	CB	CB	CB	CB	CB	CB	CB	DD	DD	DD	DD	DD	DD	DD	DD	DD	DD	DD	DD	DD	DD	EB	EB	EB	EB	EB	EB	EB	EB	EB
68000 pF	683	J	K	M	BB	BB	BB	BB	BB	CB	CB	CB	CB	CB	CB	CB	DD	DD	DD	DD	DD	DD	DD	DD	DD	DD	DD	DD	DD	DD	EB	EB	EB	EB	EB	EB	EB	EB	EB
82000 pF	823	J	K	M	BB	BB	BB	BB	BB	CB	CB	CB	CB	CB	CB	CB	DD	DD	DD	DD	DD	DD	DD	DD	DD	DD	DD	DD	DD	DD	EB	EB	EB	EB	EB	EB	EB	EB	EB
0.1 μF	104	J	K	M	BB	BB	BB	BB	BB	CB	CB	CB	CB	CB	CB	CB	DC	DC	DC	DC	DC	DC	DC	DC	DC	DC	DC	DC	DC	DC	EB	EB	EB	EB	EB	EB	EB	EB	EM
0.12 μF	124	J	K	M						CB	CB	CB	CB	CB	CB	CB	DC	DC	DC	DC	DC	DC	DC	DC	DC	DC	DC	DC	DC	DC	EC	EC	EC	EC	EC	EC	EC	EC	EG
0.15 μF	154	J	K	M						CB	CB	CB	CB	CB	CB	CB	DC	DC	DC	DC	DC	DC	DC	DC	DC	DC	DC	DC	DC	DC	EC	EC	EC	EC	EC	EC	EC	EC	EG
0.18 μF	184	J	K	M						CB	CB	CB	CB	CB	CB	CB	DC	DC	DC	DC	DC	DC	DC	DC	DC	DC	DC	DC	DC	DC	EC	EC	EC	EC	EC	EC	EC	EC	EG
0.22 μF	224	J	K	M						CB	CB	CB	CB	CB	CB	CB	DC	DC	DC	DC	DC	DC	DC	DC	DC	DC	DC	DC	DC	DC	EC	EC	EC	EC	EC	EC	EC	EC	EG
0.27 μF	274	J	K	M						CB	CB	CB	CB	CB	CB	CB	DD	DD	DD	DD	DD	DD	DD	DD	DD	DD	DD	DD	DD	DD	EB	EB	EB	EB	EB	EB	EB	EB	EM
0.33 μF	334	J	K	M						CB	CB	CB	CB	CB	CB	CB	DG	DG	DG	DG	DG	DG	DG	DG	DG	DG	DG	DG	DG	DG	EB	EB	EB	EB	EB	EB	EB	EB	EG
0.39 μF	394	J	K	M						CB	CB	CB	CB	CB	CB	CB	DG	DG	DG	DG	DG	DG	DG	DG	DG	DG	DG	DG	DG	DG	EB	EB	EB	EB	EB	EB	EB	EB	EG
0.47 μF	474	J	K	M						CB	CB	CB	CB	CB	CB	CB	DG	DG	DG	DG	DG	DE	DE	DE	DE	DE	DE	DE	DE	DE	EC	EC	EC	EC	EC	EC	EC	EC	EG
0.56 μF	564	J	K	M													DD	DD	DD	DD	DD	DH	DH	DH	DH	DH	DH	DH	DH	DH	ED	ED	ED	ED	ED	ED	ED	ED	EH
0.68 μF	684	J	K	M													DD	DD	DD	DD	DD	DH	DH	DH	DH	DH	DH	DH	DH	DH	EE	EE	EE	EE	EE	EE	EE	EE	EH
0.82 μF	824	J	K	M													DD	DD	DD	DD	DD	DG	DG	DG	DG	DG	DG	DG	DG	DG	EF	EF	EF	EF	EF	EF	EF	EF	EH
1 μF	105	J	K	M													DD	DD	DD	DD	DD	DG	DG	DG	DG	DG	DG	DG	DG	DG	EF	EF	EF	EF	EF	EF	EF	EF	EH
1.2 μF	125	J	K	M													DE	DE	DE	DE	DE	DE	DE	DE	DE	DE	DE	DE	DE	DE	ED	ED	ED	ED	ED	ED	ED	ED	EH
1.5 μF	155	J	K	M													DG	DG	DG	DG	DG	DG	DG	DG	DG	DG	DG	DG	DG	DG	ED	ED	ED	ED	ED	ED	ED	ED	EH
1.8 μF	185	J	K	M													DG	DG	DG	DG	DG	DG	DG	DG	DG	DG	DG	DG	DG	DG	ED	ED	ED	ED	ED	ED	ED	ED	EH
2.2 μF	225	J	K	M													DG	DG	DG	DG	DG	DG	DG	DG	DG	DG	DG	DG	DG	DG	ED	ED	ED	ED	ED	ED	ED	ED	EH
2.7 μF	275	J	K	M																											EN	EN	EN	EN	EN	EN	EN	EN	EH
3.3 μF	335	J	K	M																											ED	ED	ED	ED	ED	ED	ED	ED	EH

Table 1B – Capacitance Range/Selection Waterfall (1210 – 2225 Case Sizes)

Capacitance	Cap Code	Case Size / Series	C1210C								C1808C			C1812C					C1825C				C2220C					C2225C					
			Voltage Code	9	8	4	3	5	1	2	A	5	1	2	3	5	1	2	A	5	1	2	A	3	5	1	2	A	5	1	2	A	
			Rated Voltage (VDC)	6.3	10	16	25	50	100	200	250	50	100	200	25	50	100	200	250	50	100	200	250	25	50	100	200	250	50	100	200	250	
			Capacitance Tolerance	Product Availability and Chip Thickness Codes – See Table 2 for Chip Thickness Dimensions																													
10 - 91 pF*	100 - 910*	J K M	FB	FB	FB	FB	FB	FB	FB																								
100 - 270 pF**	101 - 271**	J K M	FB	FB	FB	FB	FB	FB	FB																								
330 pF	331	J K M	FB	FB	FB	FB	FB	FB	FB		LF	LF	LF																				
390 pF	391	J K M	FB	FB	FB	FB	FB	FB	FB		LF	LF	LF																				
470 - 1,200 pF**	471 - 122**	J K M	FB	FB	FB	FB	FB	FB	FB		LF	LF	LF	GB	GB	GB	GB																
1,500 pF	152	J K M	FB	FB	FB	FB	FB	FB	FE		LF	LF	LF	GB	GB	GB	GB																
1,800 pF	182	J K M	FB	FB	FB	FB	FB	FB	FE		LF	LF	LF	GB	GB	GB	GB																
2,200 pF	222	J K M	FB	FB	FB	FB	FB	FB	FB	FB	FB	FB	FB	LF	LF	LF	LF																
2,700 pF	272	J K M	FB	FB	FB	FB	FB	FB	FB	FB	FB	FB	FB	LF	LF	LF	LF																
3,300 pF	332	J K M	FB	FB	FB	FB	FB	FB	FB	FB	FB	FB	FB	LF	LF	LF	LF																
3,900 pF	392	J K M	FB	FB	FB	FB	FB	FB	FB	FB	FB	FB	FB	LF	LF	LF	LF	GB	GB	GB	GB	HB	HB	HB									
4,700 pF	472	J K M	FB	FB	FB	FB	FB	FB	FB	FB	FB	FB	FB	LD	LD	LD	LD	GB	GB	GB	GD	HB	HB	HB					KE	KE	KE		
5,600 pF	562	J K M	FB	FB	FB	FB	FB	FB	FB	FB	FB	FB	FB	LD	LD	LD	LD	GB	GB	GB	GH	HB	HB	HB					KE	KE	KE		
6,800 pF	682	J K M	FB	FB	FB	FB	FB	FB	FB	FB	FB	FB	FB	LD	LD	LD	LD	GB	GB	GB	GB	GB	HB	HB	HB	JE	JE	JE		KE	KE	KE	
8,200 pF	822	J K M	FB	FB	FB	FB	FB	FB	FB	FB	FB	FB	FB	LD	LD	LD	LD	GB	GB	GB	GB	GB	HB	HB	HB	JE	JE	JE		KE	KE	KE	
10,000 pF	103	J K M	FB	FB	FB	FB	FB	FB	FB	FB	FB	FB	FB	LD	LD	LD	LD	GB	GB	GB	GB	GB	HB	HB	HB	JE	JE	JE		KE	KE	KE	
12,000 pF	123	J K M	FB	FB	FB	FB	FB	FB	FB	FB	FB	FB	FB	LD	LD	LD	LD	GB	GB	GB	GB	GB	HB	HB	HB	JE	JE	JE		KE	KE	KE	
15,000 pF	153	J K M	FB	FB	FB	FB	FB	FB	FB	FB	FB	FB	FB	LD	LD	LD	LD	GB	GB	GB	GB	GB	HB	HB	HB	JE	JE	JE		KE	KE	KE	
18,000 pF	183	J K M	FB	FB	FB	FB	FB	FB	FB	FB	FB	FB	FB	LD	LD	LD	LD	GB	GB	GB	GB	GB	HB	HB	HB	JE	JE	JE		KE	KE	KE	
22,000 pF	223	J K M	FB	FB	FB	FB	FB	FB	FB	FB	FB	FB	FB	LD	LD	LD	LD	GB	GB	GB	GB	GB	HB	HB	HB	JE	JE	JE		KE	KE	KE	
27,000 pF	273	J K M	FB	FB	FB	FB	FB	FB	FB	FB	FB	FB	FB	LD	LD			GB	GB	GB	GB	GB	HB	HB	HB	HB	JE	JE	JE		KE	KE	
33,000 pF	333	J K M	FB	FB	FB	FB	FB	FB	FB	FB	FB	FB	FB	LD	LD			GB	GB	GB	GB	GB	HB	HB	HB	HB	JB	JB	JB		KE		
39,000 pF	393	J K M	FB	FB	FB	FB	FB	FB	FB	FB	FB	FB	FB	LD	LD			GB	GB	GB	GB	GB	HB	HB	HB	HB	JB	JB	JB				
47,000 pF	473	J K M	FB	FB	FB	FB	FB	FB	FB	FB	FC	FC	FC	LD	LD			GB	GB	GB	GB	GB	HB	HB	HB	HB	JB	JB	JB				
56,000 pF	563	J K M	FB	FB	FB	FB	FB	FB	FB	FB	FC	FC	FC	LD	LD			GB	GB	GB	GB	GB	HB	HB	HB	HB	JB	JB	JB				
68,000 pF	683	J K M	FB	FB	FB	FB	FB	FB	FC	FC	LD	LD					GB	GB	GB	GB	GB	HB	HB	HB	HB	JB	JB	JB					
82,000 pF	823	J K M	FB	FB	FB	FB	FB	FC	FF	FF	LD						GB	GB	GB	GB	GB	HB	HB	HB	HB	JC	JC	JC	JC	JC			
0.10 µF	104	J K M	FB	FB	FB	FB	FB	FB	FD	FG	LD						GB	GB	GB	GB	GB	HB	HB	HB	HB	JC	JC	JC	JC	JC	KC	KC	KC
0.12 µF	124	J K M	FB	FB	FB	FB	FB	FD			LD						GB	GB	GB	GB	GB	HB	HB	HB	HB	JC	JC	JC	JC	JC	KC	KC	KC
0.15 µF	154	J K M	FC	FC	FC	FC	FC	FD			LD						GB	GB	GB	GE	GE	HB	HB	HB	HB	JC	JC	JC	JC	JC	KC	KC	KC
0.18 µF	184	J K M	FC	FC	FC	FC	FC	FD			LD						GB	GB	GB	GG	GG	HB	HB	HB	HB	JC	JC	JC	JC	JC	KC	KC	KC
0.22 µF	224	J K M	FC	FC	FC	FC	FC	FD									GB	GB	GB	GG	GG	HB	HB	HB	HB	JC	JC	JC	JC	JC	KC	KC	KC
0.27 µF	274	J K M	FC	FC	FC	FC	FC	FD									GB	GB	GG	GG	GG	HB	HB	HB	HB	JC	JC	JC	JC	JC	KC	KC	KC
0.33 µF	334	J K M	FD	FD	FD	FD	FD	FD									GB	GB	GG	GG	GG	HB	HB	HB	HB	JC	JC	JC	JC	JC	KB	KC	KC
0.39 µF	394	J K M	FD	FD	FD	FD	FD	FD									GB	GB	GG	GG	GG	HB	HB	HD	HD	JC	JC	JC	JC	JC	KB	KC	KC
0.47 µF	474	J K M	FD	FD	FD	FD	FD	FD									GB	GB	GG	GJ	GJ	HB	HB	HD	HD	JC	JC	JC	JC	JC	KB	KC	KD
0.56 µF	564	J K M	FD	FD	FD	FD	FD	FF									GC	GC	GC			HB	HD	HD	HD	JC	JC	JC	JC	JC	KB	KC	KD
0.68 µF	684	J K M	FD	FD	FD	FD	FD	FG									GC	GC	GG			HB	HD	HD	HD	JC	JC	JD	JD	JD	KB	KC	KD
0.82 µF	824	J K M	FF	FF	FF	FF	FF	FL									GE	GE	GG			HB	HF	HF	HF	JC	JC	JF	JF	JF	KB	KC	KE
1.0 µF	105	J K M	FH	FH	FH	FH	FH	FM									GE	GE	GG			HB	HF	HF	HF	JC	JC	JF	JF	JF	KB	KD	KE
1.2 µF	125	J K M	FH	FH	FH	FH	FG															HB				JC	JC				KB	KE	KE
1.5 µF	155	J K M	FH	FH	FH	FH	FG															HC				JC	JC				KC		
1.8 µF	185	J K M	FH	FH	FH	FH	FG															HD				JD	JD				KD		
2.2 µF	225	J K M	FJ	FJ	FJ	FJ	FG										GO	GO				HF				JF	JF				KD		
2.7 µF	275	J K M	FE	FE	FE	FE	FG																										
3.3 µF	335	J K M	FF	FF	FF	FM	FM																										
3.9 µF	395	J K M	FG	FG	FG	FG	FK																										
Cap	Cap Code	Rated Voltage (VDC)	6.3	10	16	25	50	100	200	250	50	100	200	25	50	100	200	250	50	100	200	250	25	50	100	200	250	50	100	200	250		
		Voltage Code	9	8	4	3	5	1	2	A	5	1	2	3	5	1	2	A	5	1	2	A	3	5	1	2	A	5	1	2	A		
		Case Size / Series	C1210C								C1808C			C1812C					C1825C				C2220C					C2225C					

*Capacitance range Includes E24 decade values only. (i.e., 10, 11, 12, 13, 15, 16, 18, 20, 22, 24, 27, 30, 33, 36, 39, 43, 47, 51, 56, 62, 68, 75, 82 and 91)

**Capacitance range Includes E12 decade values only. (i.e., 10, 12, 15, 18, 22, 27, 33, 39, 47, 56, 68 and 82)

Table 1B – Capacitance Range/Selection Waterfall (1210 – 2225 Case Sizes) cont'd

Capacitance	Cap Code	Case Size / Series	C1210C					C1808C			C1812C					C1825C				C2220C					C2225C							
			Product Availability and Chip Thickness Codes – See Table 2 for Chip Thickness Dimensions																													
			Voltage Code	9	8	4	3	5	1	2	A	5	1	2	3	5	1	2	A	5	1	2	A	3	5	1	2	A	5	1	2	A
			Rated Voltage (VDC)	6.3	10	16	25	50	100	200	250	50	100	200	25	50	100	200	250	50	100	200	250	25	50	100	200	250	50	100	200	250
4.7 µF	475	J K M	FC	FC	FC	FG	FS				GK	GK									JF	JF										
5.6 µF	565	J K M	FF	FF	FF	FF																										
6.8 µF	685	J K M	FG	FG	FG	FM																										
8.2 µF	825	J K M	FH	FH	FH	FK																										
10 µF	106	J K M	FH	FH	FH	FS					GK										JF	JO										
15 µF	156	J K M	FM	FM	FM																JO	JO										
22 µF	226	J K M	FS	FS																	JO											
Cap	Cap Code	Case Size / Series	C1210C					C1808C			C1812C					C1825C				C2220C					C2225C							
			Rated Voltage (VDC)	6.3	10	16	25	50	100	200	250	50	100	200	25	50	100	200	250	50	100	200	250	25	50	100	200	250	50	100	200	250
			Voltage Code	9	8	4	3	5	1	2	A	5	1	2	3	5	1	2	A	5	1	2	A	3	5	1	2	A	5	1	2	A

*Capacitance range Includes E24 decade values only. (i.e., 10, 11, 12, 13, 15, 16, 18, 20, 22, 24, 27, 30, 33, 36, 39, 43, 47, 51, 56, 62, 68, 75, 82 and 91)
 **Capacitance range Includes E12 decade values only. (i.e., 10, 12, 15, 18, 22, 27, 33, 39, 47, 56, 68 and 82)

Table 2 – Chip Thickness/Packaging Quantities

Thickness Code	Case Size	Thickness ± Range (mm)	Paper Quantity		Plastic Quantity	
			7" Reel	13" Reel	7" Reel	13" Reel
BB	0402	0.50 ± 0.05	10,000	50,000	0	0
CB	0603	0.80 ± 0.07	4,000	10,000	0	0
CF	0603	0.80 ± 0.07	4,000	15,000	0	0
DE	0805	0.70 ± 0.20	4,000	10,000	0	0
DC	0805	0.78 ± 0.10	4,000	10,000	0	0
DD	0805	0.90 ± 0.10	4,000	10,000	0	0
DG	0805	1.25 ± 0.15	0	0	2,500	10,000
DH	0805	1.25 ± 0.20	0	0	2,500	10,000
EB	1206	0.78 ± 0.10	4,000	10,000	4,000	10,000
EC	1206	0.90 ± 0.10	0	0	4,000	10,000
ED	1206	1.00 ± 0.10	0	0	2,500	10,000
EE	1206	1.10 ± 0.10	0	0	2,500	10,000
EF	1206	1.20 ± 0.15	0	0	2,500	10,000
EM	1206	1.25 ± 0.15	0	0	2,500	10,000
EG	1206	1.60 ± 0.15	0	0	2,000	8,000
EH	1206	1.60 ± 0.20	0	0	2,000	8,000
FB	1210	0.78 ± 0.10	0	0	4,000	10,000
FC	1210	0.90 ± 0.10	0	0	4,000	10,000
FD	1210	0.95 ± 0.10	0	0	4,000	10,000
FE	1210	1.00 ± 0.10	0	0	2,500	10,000
FF	1210	1.10 ± 0.10	0	0	2,500	10,000
FG	1210	1.25 ± 0.15	0	0	2,500	10,000
FL	1210	1.40 ± 0.15	0	0	2,000	8,000
FH	1210	1.55 ± 0.15	0	0	2,000	8,000
Thickness Code	Case Size	Thickness ± Range (mm)	7" Reel	13" Reel	7" Reel	13" Reel
			Paper Quantity		Plastic Quantity	

Package quantity based on finished chip thickness specifications.

Table 2 – Chip Thickness/Packaging Quantities cont'd

Thickness Code	Case Size	Thickness ± Range (mm)	Paper Quantity		Plastic Quantity	
			7" Reel	13" Reel	7" Reel	13" Reel
FM	1210	1.70 ± 0.20	0	0	2,000	8,000
FJ	1210	1.85 ± 0.20	0	0	2,000	8,000
FK	1210	2.10 ± 0.20	0	0	2,000	8,000
FS	1210	2.50 ± 0.30	0	0	1,000	4,000
LD	1808	0.90 ± 0.10	0	0	2,500	10,000
LF	1808	1.00 ± 0.15	0	0	2,500	10,000
GB	1812	1.00 ± 0.10	0	0	1,000	4,000
GC	1812	1.10 ± 0.10	0	0	1,000	4,000
GD	1812	1.25 ± 0.15	0	0	1,000	4,000
GE	1812	1.30 ± 0.10	0	0	1,000	4,000
GH	1812	1.40 ± 0.15	0	0	1,000	4,000
GG	1812	1.55 ± 0.10	0	0	1,000	4,000
GK	1812	1.60 ± 0.20	0	0	1,000	4,000
GJ	1812	1.70 ± 0.15	0	0	1,000	4,000
GO	1812	2.50 ± 0.20	0	0	500	2,000
HB	1825	1.10 ± 0.15	0	0	1,000	4,000
HC	1825	1.15 ± 0.15	0	0	1,000	4,000
HD	1825	1.30 ± 0.15	0	0	1,000	4,000
HE	1825	1.40 ± 0.15	0	0	1,000	4,000
HF	1825	1.50 ± 0.15	0	0	1,000	4,000
JB	2220	1.00 ± 0.15	0	0	1,000	4,000
JC	2220	1.10 ± 0.15	0	0	1,000	4,000
JD	2220	1.30 ± 0.15	0	0	1,000	4,000
JE	2220	1.40 ± 0.15	0	0	1,000	4,000
JF	2220	1.50 ± 0.15	0	0	1,000	4,000
JO	2220	2.40 ± 0.15	0	0	500	2,000
KB	2225	1.00 ± 0.15	0	0	1,000	4,000
KC	2225	1.10 ± 0.15	0	0	1,000	4,000
KD	2225	1.30 ± 0.15	0	0	1,000	4,000
KE	2225	1.40 ± 0.15	0	0	1,000	4,000
Thickness Code	Case Size	Thickness ± Range (mm)	7" Reel	13" Reel	7" Reel	13" Reel
			Paper Quantity		Plastic Quantity	

Package quantity based on finished chip thickness specifications.

Table 3 – Chip Capacitor Land Pattern Design Recommendations per IPC–7351

EIA Size Code	Metric Size Code	Density Level A: Maximum (Most) Land Protrusion (mm)					Density Level B: Median (Nominal) Land Protrusion (mm)					Density Level C: Minimum (Least) Land Protrusion (mm)				
		C	Y	X	V1	V2	C	Y	X	V1	V2	C	Y	X	V1	V2
0402	1005	0.50	0.72	0.72	2.20	1.20	0.45	0.62	0.62	1.90	1.00	0.40	0.52	0.52	1.60	0.80
0603	1608	0.90	1.15	1.10	4.00	2.10	0.80	0.95	1.00	3.10	1.50	0.60	0.75	0.90	2.40	1.20
0805	2012	1.00	1.35	1.55	4.40	2.60	0.90	1.15	1.45	3.50	2.00	0.75	0.95	1.35	2.80	1.70
1206	3216	1.60	1.35	1.90	5.60	2.90	1.50	1.15	1.80	4.70	2.30	1.40	0.95	1.70	4.00	2.00
1210	3225	1.60	1.35	2.80	5.65	3.80	1.50	1.15	2.70	4.70	3.20	1.40	0.95	2.60	4.00	2.90
1210 ¹	3225	1.50	1.60	2.90	5.60	3.90	1.40	1.40	2.80	4.70	3.30	1.30	1.20	2.70	4.00	3.00
1808	4520	2.30	1.75	2.30	7.40	3.30	2.20	1.55	2.20	6.50	2.70	2.10	1.35	2.10	5.80	2.40
1812	4532	2.15	1.60	3.60	6.90	4.60	2.05	1.40	3.50	6.00	4.00	1.95	1.20	3.40	5.30	3.70
1825	4564	2.15	1.60	6.90	6.90	7.90	2.05	1.40	6.80	6.00	7.30	1.95	1.20	6.70	5.30	7.00
2220	5650	2.75	1.70	5.50	8.20	6.50	2.65	1.50	5.40	7.30	5.90	2.55	1.30	5.30	6.60	5.60
2225	5664	2.70	1.70	6.90	8.10	7.90	2.60	1.50	6.80	7.20	7.30	2.50	1.30	6.70	6.50	7.00

¹ Only for capacitance values $\geq 22 \mu\text{F}$

Density Level A: For low-density product applications. Recommended for wave solder applications and provides a wider process window for reflow solder processes. KEMET only recommends wave soldering of EIA 0603, 0805 and 1206 case sizes.

Density Level B: For products with a moderate level of component density. Provides a robust solder attachment condition for reflow solder processes.

Density Level C: For high component density product applications. Before adapting the minimum land pattern variations the user should perform qualification testing based on the conditions outlined in IPC Standard 7351 (IPC–7351).

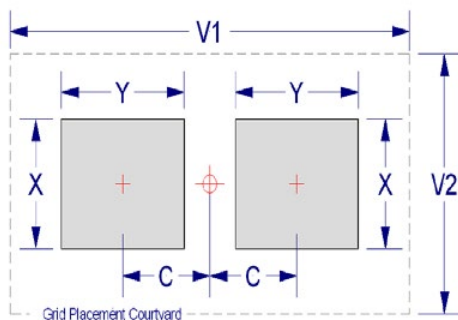

Soldering Process

Recommended Soldering Technique:

- Solder wave or solder reflow for EIA case sizes 0603, 0805 and 1206
- All other EIA case sizes are limited to solder reflow only

Recommended Soldering Profile:

- KEMET recommends following the guidelines outlined in IPC/JEDEC J–STD–020

Table 4 – Performance & Reliability: Test Methods and Conditions

Stress	Reference	Test or Inspection Method
Terminal Strength	JIS-C-6429	Appendix 1, Note: Force of 1.8 kg for 60 seconds.
Board Flex	JIS-C-6429	Appendix 2, Note: Standard termination system – 2.0 mm (minimum) for all except 3 mm for COG. Flexible termination system – 3.0 mm (minimum).
Solderability	J-STD-002	Magnification 50 X. Conditions:
		a) Method B, 4 hours @ 155°C, dry heat @ 235°C
		b) Method B @ 215°C category 3
		c) Method D, category 3 @ 260°C
Temperature Cycling	JESD22 Method JA-104	1,000 Cycles (-55°C to +125°C). Measurement at 24 hours +/- 2 hours after test conclusion.
Biased Humidity	MIL-STD-202 Method 103	Load Humidity: 1,000 hours 85°C/85% RH and rated voltage. Add 100 K ohm resistor. Measurement at 24 hours +/- 2 hours after test conclusion.
		Low Volt Humidity: 1,000 hours 85°C/85% RH and 1.5 V. Add 100 K ohm resistor. Measurement at 24 hours +/- 2 hours after test conclusion.
Moisture Resistance	MIL-STD-202 Method 106	t = 24 hours/cycle. Steps 7a and 7b not required. Unpowered. Measurement at 24 hours +/- 2 hours after test conclusion.
Thermal Shock	MIL-STD-202 Method 107	-55°C/+125°C. Note: Number of cycles required – 300, maximum transfer time – 20 seconds, dwell time – 15 minutes. Air – Air.
High Temperature Life	MIL-STD-202 Method 108 /EIA-198	1,000 hours at 125°C (85°C for X5R, Z5U and Y5V) with 2 X rated voltage applied.
Storage Life	MIL-STD-202 Method 108	150°C, 0 VDC for 1,000 hours.
Vibration	MIL-STD-202 Method 204	5 g's for 20 min., 12 cycles each of 3 orientations. Note: Use 8" X 5" PCB 0.031" thick 7 secure points on one long side and 2 secure points at corners of opposite sides. Parts mounted within 2" from any secure point. Test from 10 – 2,000 Hz
Mechanical Shock	MIL-STD-202 Method 213	Figure 1 of Method 213, Condition F.
Resistance to Solvents	MIL-STD-202 Method 215	Add aqueous wash chemical, OKEM Clean or equivalent.

Storage and Handling

Ceramic chip capacitors should be stored in normal working environments. While the chips themselves are quite robust in other environments, solderability will be degraded by exposure to high temperatures, high humidity, corrosive atmospheres, and long term storage. In addition, packaging materials will be degraded by high temperature– reels may soften or warp and tape peel force may increase. KEMET recommends that maximum storage temperature not exceed 40°C and maximum storage humidity not exceed 70% relative humidity. Temperature fluctuations should be minimized to avoid condensation on the parts and atmospheres should be free of chlorine and sulfur bearing compounds. For optimized solderability chip stock should be used promptly, preferably within 1.5 years of receipt.

Construction

Reference	Item	Material
A	Termination System	Finish
B		Barrier Layer
C		Base Metal
D	Inner Electrode	Ni
E	Dielectric Material	BaTiO ₃

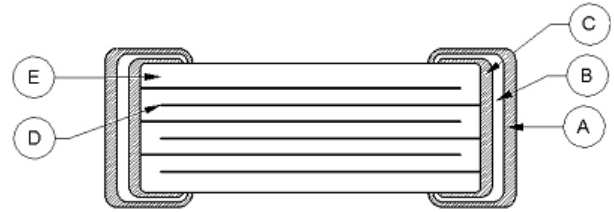

Note: Image is exaggerated in order to clearly identify all components of construction.

Commercial Off-the-Shelf (COTS) for Higher Reliability Applications, C0G Dielectric, 10 – 200 VDC

Overview

KEMET's COTS program is an extension of KEMET knowledge of high reliability test regimes and requirements. KEMET regularly supplies "up-screened" products by working with customer drawings and imposing specified design and test requirements. The COTS program offers the same high quality and high reliability components as up-screened products, but at a lower cost to the customer. This is accomplished by eliminating the need for customer-specific drawings to achieve the reliability level required for customer applications. A series of tests and inspections have been selected to provide the accelerated conditioning and 100% screening necessary to eliminate infant mortal failures from the population.

KEMET's C0G dielectric features a 125°C maximum operating temperature and is considered "stable." The Electronics Components, Assemblies & Materials Association (EIA) characterizes C0G dielectric as a Class I material. Components of this classification are temperature compensating and are suited for resonant circuit applications or those where Q and stability of capacitance characteristics are required. C0G exhibits no change in capacitance with respect to time and voltage and boasts a negligible change in capacitance with reference to ambient

temperature. Capacitance change is limited to ± 30 ppm/°C from -55°C to +125°C.

All COTS testing includes voltage conditioning and post-electrical testing as per MIL-PRF-55681. For enhanced reliability, KEMET also provides the following test level options and conformance certifications:

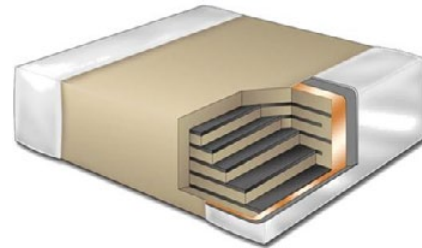
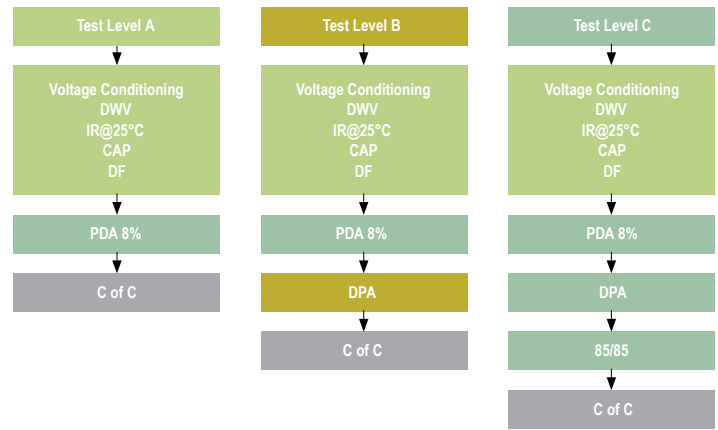

Ordering Information

C	1206	T	104	K	5	G	A	C	TU
Ceramic	Case Size (L" x W")	Specification/ Series	Capacitance Code (pF)	Capacitance Tolerance ¹	Voltage	Dielectric	Failure Rate/Design	Termination Finish ²	Packaging/Grade (C-Spec) ³
	0402 0603 0805 1206 1210 1812 2220	T = COTS	2 Significant Digits + Number of Zeros Use 9 for 1.0 – 9.9 pF Use 8 for 0.5 – .99 pF ex. 2.2 pF = 229 ex. 0.5 pF = 508	B = ± 0.10 pF C = ± 0.25 pF D = ± 0.5 pF F = $\pm 1\%$ G = $\pm 2\%$ J = $\pm 5\%$ K = $\pm 10\%$ M = $\pm 20\%$	8 = 10 V 4 = 16 V 3 = 25 V 6 = 35 V 5 = 50 V 1 = 100 V 2 = 200 V	G = C0G	A = Testing per MIL-PRF-55681 PDA 8% B = Testing per MIL-PRF-55681 PDA 8%, DPA per EIA-469 C = Testing per MIL-PRF-55681 PDA 8%, DPA per EIA-469, Humidity per MIL-STD-202, Method 103, Condition A	C = 100% Matte Sn L = SnPb (5% minimum)	Blank = Bulk TU = 7" Reel Unmarked TM = 7" Reel Marked

¹ Additional capacitance tolerance offerings may be available. Contact KEMET for details.

² Additional termination finish options may be available. Contact KEMET for details.

³ Additional reeling or packaging options may be available. Contact KEMET for details.

Dimensions – Millimeters (Inches)

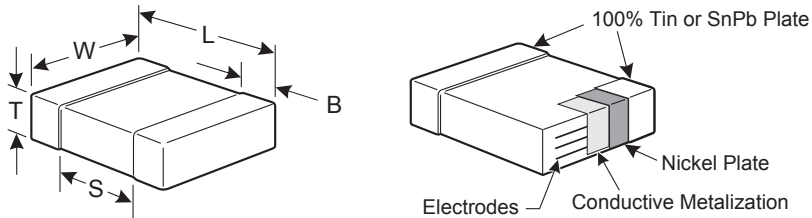

EIA Size Code	Metric Size Code	L Length	W Width	T Thickness	B Bandwidth	S Separation Minimum	Mounting Technique
0402	1005	1.00 (.040) ± 0.05 (.002)	0.50 (.020) ± 0.05 (.002)	See Table 2 for Thickness	0.30 (.012) ± 0.10 (.004)	0.30 (.012)	Solder Reflow Only
0603	1608	1.60 (.063) ± 0.15 (.006)	0.80 (.032) ± 0.15 (.006)		0.35 (.014) ± 0.15 (.006)	0.70 (.028)	Solder Wave or Solder Reflow
0805	2012	2.00 (.079) ± 0.20 (.008)	1.25 (.049) ± 0.20 (.008)		0.50 (0.02) ± 0.25 (.010)	0.75 (.030)	
1206	3216	3.20 (.126) ± 0.20 (.008)	1.60 (.063) ± 0.20 (.008)		0.50 (0.02) ± 0.25 (.010)	N/A	Solder Reflow Only
1210	3225	3.20 (.126) ± 0.20 (.008)	2.50 (.098) ± 0.20 (.008)		0.50 (0.02) ± 0.25 (.010)		
1812	4532	4.50 (.177) ± 0.30 (.012)	3.20 (.126) ± 0.30 (.012)		0.60 (.024) ± 0.35 (.014)		
2220	5650	5.70 (.224) ± 0.40 (.016)	5.00 (.197) ± 0.40 (.016)		0.60 (.024) ± 0.35 (.014)		

Benefits

- -55°C to +125°C operating temperature range
- Voltage conditioning and post-electrical testing per MIL-PRF-55681, Paragraph 4.8.3.1, Standard Voltage Conditioning
- Destructive Physical Analysis (DPA) per EIA-469
- Humidity, steady state, low voltage (85/85) per MIL-STD-202, Method 103, Condition A
- Certificate of compliance
- RoHS Compliant (excluding SnPb end metallization option)
- EIA 0402, 0603, 0805, 1206, 1210, 1812, and 2220 case sizes
- DC voltage ratings of 10 V, 16 V, 25 V, 50 V, 100 V, and 200 V
- Capacitance offerings ranging from 0.5 pF up to 0.47 µF
- Available capacitance tolerances of ±0.10 pF, ±0.25 pF, ±0.5 pF, ±1%, ±2%, ±5%, ±10%, and ±20%
- No piezoelectric noise
- Extremely low ESR and ESL
- High thermal stability
- High ripple current capability
- Preferred capacitance solution at line frequencies and into the MHz range
- No capacitance change with respect to applied rated DC voltage
- Negligible capacitance change with respect to temperature
- No capacitance decay with time
- Non-polar device, minimizing installation concerns
- SnPb end metallization option available upon request (5% minimum)

Applications

Typical applications include military, space quality and high reliability electronics.

Qualification/Certification

Commercial Grade products are subject to internal qualification. Details regarding test methods and conditions are referenced in Table 4, Performance & Reliability.

Environmental Compliance

Pb-Free and RoHS Compliant.



RoHS Compliant

Electrical Parameters/Characteristics

Item	Parameters/Characteristics
Operating Temperature Range	-55°C to +125°C
Capacitance Change with Reference to +25°C and 0 VDC Applied (TCC)	±30 ppm/°C
Aging Rate (Maximum % Capacitance Loss/Decade Hour)	0%
Dielectric Withstanding Voltage (DWV)	250% of rated voltage (5 ±1 seconds and charge/discharge not exceeding 50 mA)
Dissipation Factor (DF) Maximum Limit @ 25°C	0.1%
Insulation Resistance (IR) Limit @ 25°C	1,000 megohm microfarads or 100 GΩ (Rated voltage applied for 120 ±5 seconds @ 25°C)

To obtain IR limit, divide MΩ-μF value by the capacitance and compare to GΩ limit. Select the lower of the two limits.

Capacitance and dissipation factor (DF) measured under the following conditions:

1 MHz ±100 kHz and 1.0 Vrms ±0.2 V if capacitance ≤ 1,000 pF

1 kHz ±50 Hz and 1.0 Vrms ±0.2 V if capacitance > 1,000 pF

Note: When measuring capacitance it is important to ensure the set voltage level is held constant. The HP4284 and Agilent E4980 have a feature known as Automatic Level Control (ALC). The ALC feature should be switched to "ON."

Post Environmental Limits

High Temperature Life, Biased Humidity, Moisture Resistance					
Dielectric	Rated DC Voltage	Capacitance Value	Dissipation Factor (Maximum %)	Capacitance Shift	Insulation Resistance
COG	All	All	0.5	0.3% or ±0.25 pF	10% of Initial Limit

Table 1A – Capacitance Range/Selection Waterfall (0402 – 0805 Case Sizes)

Capacitance	Cap Code	Case Size / Series			C0402C						C0603C						C0805C											
		Voltage Code			8	4	3	5	1	2	8	4	3	5	1	2	8	4	3	5	1	2						
		Rated Voltage (VDC)			10	16	25	50	100	200	10	16	25	50	100	200	10	16	25	50	100	200						
		Capacitance Tolerance			Product Availability and Chip Thickness Codes See Table 2 for Chip Thickness Dimensions																							
0.50 & 0.75 pF	508 & 758	B	C	D							BB	BB	BB	BB			CB	CB	CB	CB	CB	CB	DC	DC	DC	DC	DC	DC
1.0 - 9.1 pF*	109 - 919*	B	C	D	F	G	J	K	M	BB	BB	BB	BB			CB	CB	CB	CB	CB	CB	DC	DC	DC	DC	DC	DC	
10 - 91 pF*	100 - 910*				F	G	J	K	M	BB	BB	BB	BB			CB	CB	CB	CB	CB	CB	DC	DC	DC	DC	DC	DC	
100 pF	101				F	G	J	K	M	BB	BB	BB	BB	BB	BB	CB	CB	CB	CB	CB	CB	DC	DC	DC	DC	DC	DC	
110 - 270 pF*	111 - 271*				F	G	J	K	M	BB	BB	BB	BB	BB	BB	CB	CB	CB	CB	CB	CB	DC	DC	DC	DC	DC	DC	
300 pF	301				F	G	J	K	M	BB	BB	BB	BB	BB	BD	CB	CB	CB	CB	CB	CB	DC	DC	DC	DC	DC	DC	
330 pF	331				F	G	J	K	M	BB	BB	BB	BB	BB	BD	CB	CB	CB	CB	CB	CB	DC	DC	DC	DC	DC	DC	
360 pF	361				F	G	J	K	M	BB	BB	BB	BB	BB		CB	CB	CB	CB	CB	CB	DC	DC	DC	DC	DC	DC	
390 pF	391				F	G	J	K	M	BB	BB	BB	BB	BB		CB	CB	CB	CB	CB	CB	DC	DC	DC	DC	DC	DC	
430 pF	431				F	G	J	K	M	BB	BB	BB	BB	BB		CB	CB	CB	CB	CB	CB	DC	DC	DC	DC	DC	DC	
470 pF	471				F	G	J	K	M	BB	BB	BB	BB	BB		CB	CB	CB	CB	CB	CB	DC	DC	DC	DC	DC	DC	
510 - 820 pF*	511 - 821*				F	G	J	K	M	BB	BB	BB	BB	BB		CB	CB	CB	CB	CB	CB	DC	DC	DC	DC	DC	DC	
910 pF	911				F	G	J	K	M	BB	BB	BB	BB	BB		CB	CB	CB	CB	CB	CB	DC	DC	DC	DC	DC	DC	
1,000 pF	102				F	G	J	K	M	BB	BB	BB	BB	BB		CB	CB	CB	CB	CB	CB	DC	DC	DC	DC	DC	DC	
1,100 pF	112				F	G	J	K	M	BB	BB	BB	BB	BB		CB	CB	CB	CB	CB	CH	DC	DC	DC	DC	DC	DC	
1,200 pF	122				F	G	J	K	M	BB	BB	BB	BB			CB	CB	CB	CB	CB	CH	DC	DC	DC	DC	DC	DC	
1,300 pF	132				F	G	J	K	M	BB	BB	BB	BB			CB	CB	CB	CB	CB	CH	DD	DD	DD	DD	DD	DC	
1,500 pF	152				F	G	J	K	M	BB	BB	BB	BB			CB	CB	CB	CB	CB	CH	DD	DD	DD	DD	DD	DC	
1,600 pF	162				F	G	J	K	M	BB	BB	BB	BB			CB	CB	CB	CB	CB	CH	DD	DD	DD	DD	DD	DC	
1,800 pF	182				F	G	J	K	M	BB	BB	BB	BB			CB	CB	CB	CB	CB	CH	DD	DD	DD	DD	DD	DC	
2,000 pF	202				F	G	J	K	M	BB	BB	BB	BB			CB	CB	CB	CB	CB	CH	DC	DC	DC	DC	DC	DC	
2,200 pF	222				F	G	J	K	M	BB	BB	BB	BB			CB	CB	CB	CB	CB	CH	DC	DC	DC	DC	DC	DC	
2,400 pF	242				F	G	J	K	M							CB	CB	CB	CB	CB		DC	DC	DC	DC	DC	DC	
2,700 pF	272				F	G	J	K	M							CB	CB	CB	CB	CB		DC	DC	DC	DC	DC	DC	
3,000 pF	302				F	G	J	K	M							CB	CB	CB	CB	CB		DD	DD	DD	DD	DD	DC	
3,300 pF	332				F	G	J	K	M							CB	CB	CB	CB	CB		DD	DD	DD	DD	DD	DC	
3,600 pF	362				F	G	J	K	M							CB	CB	CB	CB	CB		DD	DD	DD	DD	DD	DC	
3,900 pF	392				F	G	J	K	M							CB	CB	CB	CB	CB		DE	DE	DE	DE	DE	DC	
4,300 pF	432				F	G	J	K	M							CB	CB	CB	CB	CB		DE	DE	DE	DE	DE	DC	
4,700 pF	472				F	G	J	K	M							CB	CB	CB	CB	CB		DE	DE	DE	DE	DE	DC	
5,100 pF	512				F	G	J	K	M							CB	CB	CB	CB	CB		DE	DE	DE	DE	DE	DC	
5,600 pF	562				F	G	J	K	M							CB	CB	CB	CB	CB		DC	DC	DC	DC	DC	DD	
6,200 pF	622				F	G	J	K	M							CB	CB	CB	CB	CB		DC	DC	DC	DC	DC	DG	
6,800 pF	682				F	G	J	K	M							CB	CB	CB	CB	CB		DC	DC	DC	DC	DC	DG	
7,500 pF	752				F	G	J	K	M							CB	CB	CB	CB	CB		DC	DC	DC	DC	DC	DG	
8,200 pF	822				F	G	J	K	M							CB	CB	CB	CB	CB		DC	DC	DC	DC	DC	DG	
9,100 pF	912				F	G	J	K	M							CB	CB	CB	CB	CB		DC	DC	DC	DC	DC		
10,000 pF	103				F	G	J	K	M							CB	CB	CB	CB	CB		DC	DC	DC	DC	DC	DD	
12,000 pF	123				F	G	J	K	M							CB	CB	CB	CB	CB		DC	DC	DC	DC	DC	DE	
15,000 pF	153				F	G	J	K	M							CB	CB	CB	CB	CB		DC	DC	DC	DD	DG		
18,000 pF	183				F	G	J	K	M													DC	DC	DC	DD			
22,000 pF	223				F	G	J	K	M													DD	DD	DD	DF			
27,000 pF	273				F	G	J	K	M													DF	DF	DF				
33,000 pF	333				F	G	J	K	M													DG	DG	DG				
39,000 pF	393				F	G	J	K	M													DG	DG	DG				
47,000 pF	473				F	G	J	K	M													DG	DG	DG				
Capacitance	Cap Code	Rated Voltage (VDC)			10	16	25	50	100	200	10	16	25	50	100	200	10	16	25	50	100	200						
		Voltage Code			8	4	3	5	1	2	8	4	3	5	1	2	8	4	3	5	1	2						
		Case Size / Series			C0402C						C0603C						C0805C											

*Capacitance range Includes E24 decade values only. (i.e., 10, 11, 12, 13, 15, 16, 18, 20, 22, 24, 27, 30, 33, 36, 39, 43, 47, 51, 56, 62, 68, 75, 82 and 91)
 KEMET reserves the right to substitute product with an improved temperature characteristic, tighter capacitance tolerance and/or higher voltage capability within the same form factor (configuration and dimensions).
 These products are protected under US Patents 7,172,985 & 7,670,981, other patents pending, and any foreign counterparts.

Table 1B – Capacitance Range/Selection Waterfall (1206 – 2220 Case Sizes)

Capacitance	Cap Code	Case Size / Series			C1206C						C1210C						C1812C			C2220C							
		Voltage Code			8	4	3	5	1	2	8	4	3	5	1	2	5	1	2	3	1	2					
		Rated Voltage (VDC)			10	16	25	50	100	200	10	16	25	50	100	200	50	100	200	50	100	200					
		Capacitance Tolerance			Product Availability and Chip Thickness Codes See Table 2 for Chip Thickness Dimensions																						
1.0 - 9.1 pF*	109 - 919*	B	C	D	F	G	J	K	M	EB	EB	EB	EB	EB	EB	FB	FB	FB	FB	FB	FB						
10 - 91 pF*	100 - 910*				F	G	J	K	M	EB	EB	EB	EB	EB	EB	FB	FB	FB	FB	FB	FB						
100 - 430 pF*	101 - 431*				F	G	J	K	M	EB	EB	EB	EB	EB	EB	FB	FB	FB	FB	FB	FB						
470 - 910 pF*	471 - 911*				F	G	J	K	M	EB	EB	EB	EB	EB	EB	FB	FB	FB	FB	FB	FB	GB	GB	GB			
1,000 pF	102				F	G	J	K	M	EB	EB	EB	EB	EB	EE	FB	FB	FB	FB	FB	FB	GB	GB	GB			
1,100 pF	112				F	G	J	K	M	EB	EB	EB	EB	EB	EB	FB	FB	FB	FB	FB	FB	GB	GB	GB			
1,200 pF	122				F	G	J	K	M	EB	EB	EB	EB	EB	EB	FB	FB	FB	FB	FB	FB	GB	GB	GB			
1,300 pF	132				F	G	J	K	M	EB	EB	EB	EB	EB	EC	FB	FB	FB	FB	FB	FB	GB	GB	GB			
1,500 pF	152				F	G	J	K	M	EB	EB	EB	EB	ED	EC	FB	FB	FB	FB	FB	FE	GB	GB	GB			
1,600 pF	162				F	G	J	K	M	EB	EB	EB	EB	ED	ED	FB	FB	FB	FB	FB	FE	GB	GB	GB			
1,800 pF	182				F	G	J	K	M	EB	EB	EB	EB	ED	ED	FB	FB	FB	FB	FB	FE	GB	GB	GB			
2,000 pF	202				F	G	J	K	M	EB	EB	EB	EB	ED	ED	FB	FB	FB	FB	FB	FC	GB	GB	GB			
2,200 pF	222				F	G	J	K	M	EB	EB	EB	EB	EE	ED	FB	FB	FB	FB	FC	FG	GB	GB	GB			
2,400 pF	242				F	G	J	K	M	EB	EB	EB	EB	EC	EC	FB	FB	FB	FB	FC	FC						
2,700 pF	272				F	G	J	K	M	EB	EB	EB	EB	EC	EC	FB	FB	FB	FB	FC	FC	GB	GB	GB			
3,000 pF	302				F	G	J	K	M	EC	EC	EC	EC	EC	EB	FB	FB	FB	FB	FC	FF						
3,300 pF	332				F	G	J	K	M	EC	EC	EC	EC	EE	EB	FB	FB	FB	FB	FF	FF	GB	GB	GB			
3,600 pF	362				F	G	J	K	M	EC	EC	EC	EC	EE	EB	FB	FB	FB	FB	FF	FF						
3,900 pF	392				F	G	J	K	M	EC	EC	EC	EC	EF	EB	FB	FB	FB	FB	FF	FF	GB	GB	GB			
4,300 pF	432				F	G	J	K	M	EC	EC	EC	EC	EC	EB	FB	FB	FB	FB	FF	FF						
4,700 pF	472				F	G	J	K	M	EC	EC	EC	EC	EC	EB	FF	FF	FF	FF	FG	FG	GB	GB	GD			
5,100 pF	512				F	G	J	K	M	ED	ED	ED	ED	ED	EB	FB	FB	FB	FB	FG	FG						
5,600 pF	562				F	G	J	K	M	ED	ED	ED	ED	ED	EB	FB	FB	FB	FB	FG	FG	GB	GB	GH			
6,200 pF	622				F	G	J	K	M	EB	EB	EB	EB	EB	EB	FB	FB	FB	FB	FG	FB						
6,800 pF	682				F	G	J	K	M	EB	EB	EB	EB	EB	EB	FB	FB	FB	FB	FG	FB	GB	GB	GJ	JE	JE	JB
7,500 pF	752				F	G	J	K	M	EB	EB	EB	EB	EB	EB	FC	FC	FC	FC	FC	FB						
8,200 pF	822				F	G	J	K	M	EC	EC	EC	EC	EB	EC	FC	FC	FC	FC	FC	FB	GB	GH	GB	JE	JE	JB
9,100 pF	912				F	G	J	K	M	EC	EC	EC	EC	EB	EC	FE	FE	FE	FE	FE	FB						
10,000 pF	103				F	G	J	K	M	ED	ED	ED	ED	EB	EC	FF	FF	FF	FF	FF	FB	GB	GH	GB	JE	JE	JB
12,000 pF	123				F	G	J	K	M	EB	EB	EB	EB	EB	ED	FG	FG	FG	FG	FB	FB	GB	GG	GB	JE	JE	JB
15,000 pF	153				F	G	J	K	M	EB	EB	EB	EB	EB	EF	FG	FG	FG	FG	FB	FC	GB	GB	GB	JE	JE	JB
18,000 pF	183				F	G	J	K	M	EB	EB	EB	EB	EB	EH	FB	FB	FB	FB	FB	FC	GB	GB	GB	JE	JE	JB
22,000 pF	223				F	G	J	K	M	EB	EB	EB	EB	EC	EH	FB	FB	FB	FB	FB	FF	GB	GB	GB	JE	JB	JB
27,000 pF	273				F	G	J	K	M	EB	EB	EB	EB	EE		FB	FB	FB	FB	FB	FG	GB	GB	GB	JE	JB	JB
33,000 pF	333				F	G	J	K	M	EB	EB	EB	EB	EE		FB	FB	FB	FB	FB	FH	GB	GB	GB	JB	JB	JB
39,000 pF	393				F	G	J	K	M	EC	EC	EC	EE	EH		FB	FB	FB	FB	FE	FH	GB	GB	GB	JB	JB	JB
47,000 pF	473				F	G	J	K	M	EC	EC	EC	EE	EH		FB	FB	FB	FB	FE	FJ	GB	GB	GD	JB	JB	JB
56,000 pF	563				F	G	J	K	M	ED	ED	ED	EF			FB	FB	FB	FB	FF		GB	GB	GD	JB	JB	JB
68,000 pF	683				F	G	J	K	M	EF	EF	EF	EH			FB	FB	FB	FC	FG		GB	GB	GK	JB	JB	JB
82,000 pF	823				F	G	J	K	M	EH	EH	EH				FC	FC	FC	FF	FH		GB	GB	GM	JB	JB	JB
0.10 μF	104				F	G	J	K	M	EH	EH	EH				FE	FE	FE	FG	FM		GB	GD	GM	JB	JB	JD
0.12 μF	124				F	G	J	K	M							FG	FG	FG	FH			GB	GH		JB	JB	JD
0.15 μF	154				F	G	J	K	M							FH	FH	FH	FM			GD	GN		JB	JB	JG
0.18 μF	184				F	G	J	K	M							FJ	FJ	FJ				GH			JB	JD	JG
0.22 μF	224				F	G	J	K	M							FK	FK	FK				GK			JB	JD	JL
0.27 μF	274				F	G	J	K	M																JB	JF	
0.33 μF	334				F	G	J	K	M																JD	JG	
0.39 μF	394				F	G	J	K	M																JG		
0.47 μF	474				F	G	J	K	M																JG		
Capacitance	Cap Code	Rated Voltage (VDC)			10	16	25	50	100	200	10	16	25	50	100	200	50	100	200	50	100	200					
		Voltage Code			8	4	3	5	1	2	8	4	3	5	1	2	5	1	2	3	1	2					
		Case Size / Series			C1206C						C1210C						C1812C			C2220C							

*Capacitance range Includes E24 decade values only. (i.e., 10, 11, 12, 13, 15, 16, 18, 20, 22, 24, 27, 30, 33, 36, 39, 43, 47, 51, 56, 62, 68, 75, 82 and 91)
 KEMET reserves the right to substitute product with an improved temperature characteristic, tighter capacitance tolerance and/or higher voltage capability within the same form factor (configuration and dimensions).
 These products are protected under US Patents 7,172,985 & 7,670,981, other patents pending, and any foreign counterparts.

Table 2 – Chip Thickness/Packaging Quantities

Thickness Code	Case Size	Thickness ± Range (mm)	Paper Quantity		Plastic Quantity	
			7" Reel	13" Reel	7" Reel	13" Reel
BB	402	0.50 ± 0.05	10000	50000	0	0
BD	402	0.55 ± 0.05	10000	50000	0	0
CB	603	0.80 ± 0.07	4000	10000	0	0
CF	603	0.80 ± 0.07	4000	15000	0	0
CH	603	0.85 ± 0.07	4000	10000	0	0
DE	0805	0.70 ± 0.20	4,000	10,000	0	0
DC	0805	0.78 ± 0.10	4,000	10,000	0	0
DD	0805	0.90 ± 0.10	4,000	10,000	0	0
DF	0805	1.10 ± 0.10	0	0	2,500	10,000
DG	0805	1.25 ± 0.15	0	0	2,500	10,000
EB	1206	0.78 ± 0.10	4,000	10,000	4,000	10,000
EC	1206	0.90 ± 0.10	0	0	4,000	10,000
ED	1206	1.00 ± 0.10	0	0	2,500	10,000
EE	1206	1.10 ± 0.10	0	0	2,500	10,000
EF	1206	1.20 ± 0.15	0	0	2,500	10,000
EH	1206	1.60 ± 0.20	0	0	2,000	8,000
FB	1210	0.78 ± 0.10	0	0	4,000	10,000
FC	1210	0.90 ± 0.10	0	0	4,000	10,000
FE	1210	1.00 ± 0.10	0	0	2,500	10,000
FF	1210	1.10 ± 0.10	0	0	2,500	10,000
FG	1210	1.25 ± 0.15	0	0	2,500	10,000
FH	1210	1.55 ± 0.15	0	0	2,000	8,000
FM	1210	1.70 ± 0.20	0	0	2,000	8,000
FJ	1210	1.85 ± 0.20	0	0	2,000	8,000
FK	1210	2.10 ± 0.20	0	0	2,000	8,000
GB	1812	1.00 ± 0.10	0	0	1,000	4,000
GD	1812	1.25 ± 0.15	0	0	1,000	4,000
GH	1812	1.40 ± 0.15	0	0	1,000	4,000
GG	1812	1.55 ± 0.10	0	0	1,000	4,000
GK	1812	1.60 ± 0.20	0	0	1,000	4,000
GJ	1812	1.70 ± 0.15	0	0	1,000	4,000
GN	1812	1.70 ± 0.20	0	0	1,000	4,000
GM	1812	2.00 ± 0.20	0	0	500	2,000
JB	2220	1.00 ± 0.15	0	0	1,000	4,000
JD	2220	1.30 ± 0.15	0	0	1,000	4,000
JE	2220	1.40 ± 0.15	0	0	1,000	4,000
JF	2220	1.50 ± 0.15	0	0	1,000	4,000
JG	2220	1.70 ± 0.15	0	0	1,000	4,000
JL	2220	2.00 ± 0.20	0	0	500	2,000
Thickness Code	Case Size	Thickness ± Range (mm)	7" Reel	13" Reel	7" Reel	13" Reel
			Paper Quantity		Plastic Quantity	

Package quantity based on finished chip thickness specifications.

Table 3 – Chip Capacitor Land Pattern Design Recommendations per IPC–7351

EIA Size Code	Metric Size Code	Density Level A: Maximum (Most) Land Protrusion (mm)					Density Level B: Median (Nominal) Land Protrusion (mm)					Density Level C: Minimum (Least) Land Protrusion (mm)				
		C	Y	X	V1	V2	C	Y	X	V1	V2	C	Y	X	V1	V2
0402	1005	0.50	0.72	0.72	2.20	1.20	0.45	0.62	0.62	1.90	1.00	0.40	0.52	0.52	1.60	0.80
0603	1608	0.90	1.15	1.10	4.00	2.10	0.80	0.95	1.00	3.10	1.50	0.60	0.75	0.90	2.40	1.20
0805	2012	1.00	1.35	1.55	4.40	2.60	0.90	1.15	1.45	3.50	2.00	0.75	0.95	1.35	2.80	1.70
1206	3216	1.60	1.35	1.90	5.60	2.90	1.50	1.15	1.80	4.70	2.30	1.40	0.95	1.70	4.00	2.00
1210	3225	1.60	1.35	2.80	5.65	3.80	1.50	1.15	2.70	4.70	3.20	1.40	0.95	2.60	4.00	2.90
1210 ¹	3225	1.50	1.60	2.90	5.60	3.90	1.40	1.40	2.80	4.70	3.30	1.30	1.20	2.70	4.00	3.00
1812	4532	2.15	1.60	3.60	6.90	4.60	2.05	1.40	3.50	6.00	4.00	1.95	1.20	3.40	5.30	3.70
2220	5650	2.75	1.70	5.50	8.20	6.50	2.65	1.50	5.40	7.30	5.90	2.55	1.30	5.30	6.60	5.60

¹ Only for capacitance values $\geq 22 \mu\text{F}$

Density Level A: For low-density product applications. Recommended for wave solder applications and provides a wider process window for reflow solder processes. KEMET only recommends wave soldering of EIA 0603, 0805, and 1206 case sizes.

Density Level B: For products with a moderate level of component density. Provides a robust solder attachment condition for reflow solder processes.

Density Level C: For high component density product applications. Before adapting the minimum land pattern variations the user should perform qualification testing based on the conditions outlined in IPC Standard 7351 (IPC–7351).

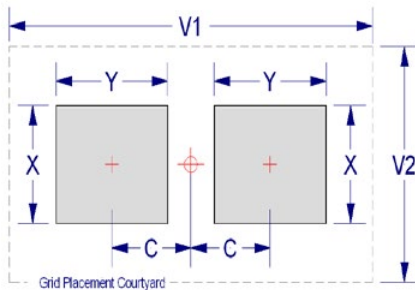

Soldering Process

Recommended Soldering Technique:

- Solder wave or solder reflow for EIA case sizes 0603, 0805, and 1206
- All other EIA case sizes are limited to solder reflow only

Recommended Soldering Profile:

- KEMET recommends following the guidelines outlined in IPC/JEDEC J–STD–020

Table 4 – Performance & Reliability: Test Methods and Conditions

Stress	Reference	Test or Inspection Method
Terminal Strength	JIS-C-6429	Appendix 1, Note: Force of 1.8 kg for 60 seconds.
Board Flex	JIS-C-6429	Appendix 2, Note: Standard termination system – 2.0 mm (minimum) for all except 3 mm for COG. Flexible termination system – 3.0 mm (minimum).
Solderability	J-STD-002	Magnification 50 X. Conditions:
		a) Method B, 4 hours @ 155°C, dry heat @ 235°C
		b) Method B @ 215°C category 3
		c) Method D, category 3 @ 260°C
Temperature Cycling	JESD22 Method JA-104	1,000 Cycles (-55°C to +125°C). Measurement at 24 hours +/- 2 hours after test conclusion.
Biased Humidity	MIL-STD-202 Method 103	Load Humidity: 1,000 hours 85°C/85% RH and rated voltage. Add 100 K ohm resistor. Measurement at 24 hours +/- 2 hours after test conclusion.
		Low Volt Humidity: 1,000 hours 85°C/85% RH and 1.5 V. Add 100 K ohm resistor. Measurement at 24 hours +/- 2 hours after test conclusion.
Moisture Resistance	MIL-STD-202 Method 106	t = 24 hours/cycle. Steps 7a and 7b not required. Unpowered. Measurement at 24 hours +/- 2 hours after test conclusion.
Thermal Shock	MIL-STD-202 Method 107	-55°C/+125°C. Note: Number of cycles required – 300, maximum transfer time – 20 seconds, dwell time – 15 minutes. Air – Air.
High Temperature Life	MIL-STD-202 Method 108 /EIA-198	1,000 hours at 125°C (85°C for X5R, Z5U and Y5V) with 2 X rated voltage applied.
Storage Life	MIL-STD-202 Method 108	150°C, 0 VDC for 1,000 hours.
Vibration	MIL-STD-202 Method 204	5 g's for 20 min., 12 cycles each of 3 orientations. Note: Use 8" X 5" PCB 0.031" thick 7 secure points on one long side and 2 secure points at corners of opposite sides. Parts mounted within 2" from any secure point. Test from 10 – 2,000 Hz
Mechanical Shock	MIL-STD-202 Method 213	Figure 1 of Method 213, Condition F.
Resistance to Solvents	MIL-STD-202 Method 215	Add aqueous wash chemical, OKEM Clean or equivalent.

Storage and Handling

Ceramic chip capacitors should be stored in normal working environments. While the chips themselves are quite robust in other environments, solderability will be degraded by exposure to high temperatures, high humidity, corrosive atmospheres, and long term storage. In addition, packaging materials will be degraded by high temperature– reels may soften or warp and tape peel force may increase. KEMET recommends that maximum storage temperature not exceed 40°C and maximum storage humidity not exceed 70% relative humidity. Temperature fluctuations should be minimized to avoid condensation on the parts and atmospheres should be free of chlorine and sulfur bearing compounds. For optimized solderability chip stock should be used promptly, preferably within 1.5 years of receipt.

Construction

Reference	Item		Material
A	Termination System	Finish	100% Matte Sn
B		Barrier Layer	Ni
C		Base Metal	Cu
D	Inner Electrode		Ni
E	Dielectric Material		CaZrO ₃

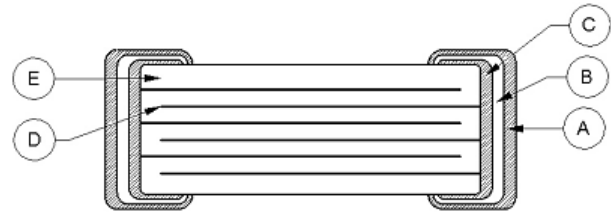

Note: Image is exaggerated in order to clearly identify all components of construction.

Capacitor Marking (Optional):

Laser marking option is not available on:

- COG, Ultra Stable X8R and Y5V dielectric devices
- EIA 0402 case size devices
- EIA 0603 case size devices with Flexible Termination option.
- KPS Commercial and Automotive grade stacked devices.

These capacitors are supplied unmarked only.

Commercial Off-the-Shelf (COTS) for Higher Reliability Applications, X7R Dielectric, 6.3 – 250 VDC

Overview

KEMET’s COTS program is an extension of KEMET knowledge of high reliability test regimes and requirements. KEMET regularly supplies “up-screened” products by working with customer drawings and imposing specified design and test requirements. The COTS program offers the same high quality and high reliability components as up-screened products, but at a lower cost to the customer. This is accomplished by eliminating the need for customer-specific drawings to achieve the reliability level required for customer applications. A series of tests and inspections have been selected to provide the accelerated conditioning and 100% screening necessary to eliminate infant mortal failures from the population.

KEMET’s X7R dielectric features a 125°C maximum operating temperature and is considered “temperature stable.” The Electronics Components, Assemblies & Materials Association (EIA) characterizes X7R dielectric as a Class II material. Components of this classification are fixed, ceramic dielectric capacitors suited for bypass and decoupling applications or for frequency discriminating circuits where Q and stability of capacitance characteristics are not critical. X7R exhibits a predictable change in capacitance with respect to time and voltage and boasts a minimal change in capacitance with reference to ambient temperature. Capacitance change is limited to ±15% from -55°C to +125°C.

All COTS testing includes voltage conditioning and post-electrical testing as per MIL-PRF-55681. For enhanced reliability, KEMET also provides the following test level options and conformance certifications:

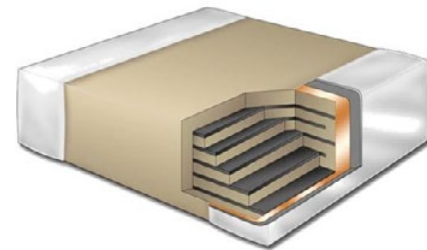
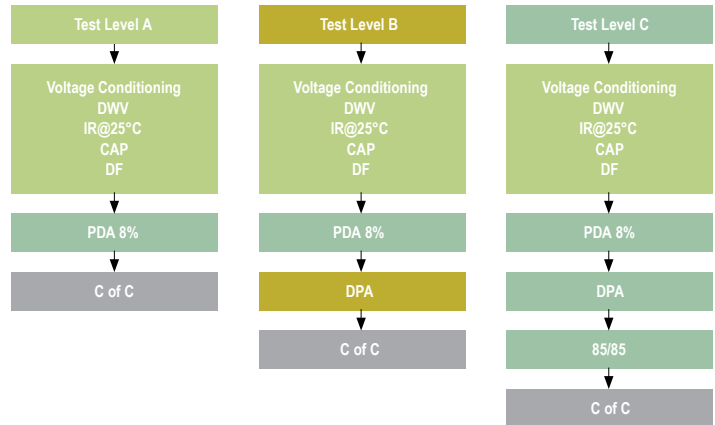

Ordering Information

C	1210	T	104	K	5	R	A	C	TU
Ceramic	Case Size (L" x W")	Specification/ Series	Capacitance Code (pF)	Capacitance Tolerance	Voltage	Dielectric	Failure Rate/Design	Termination Finish ¹	Packaging/Grade (C-Spec) ²
	0402 0603 0805 1206 1210 1812 2220	T = COTS	2 Significant Digits + Number of Zeros	J = ±5% K = ±10% M = ±20%	9 = 6.3 V 8 = 10 V 4 = 16 V 3 = 25 V 5 = 50 V 1 = 100 V 2 = 200 V A = 250 V	R = X7R	A = Testing per MIL-PRF-55681 PDA 8% B = Testing per MIL-PRF-55681 PDA 8%, DPA per EIA-469 C = Testing per MIL-PRF-55681 PDA 8%, DPA per EIA-469, Humidity per MIL-STD-202, Method 103, Condition A	C = 100% Matte Sn L = SnPb (5% minimum)	Blank = Bulk TU = 7" Reel Unmarked TM = 7" Reel Marked

¹ Additional termination finish options may be available. Contact KEMET for details.

² Additional reeling or packaging options may be available. Contact KEMET for details.

Dimensions – Millimeters (Inches)

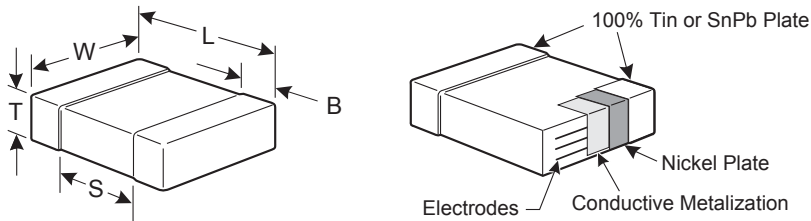

EIA Size Code	Metric Size Code	L Length	W Width	T Thickness	B Bandwidth	S Separation Minimum	Mounting Technique
0402	1005	1.00 (.040) ± 0.05 (.002)	0.50 (.020) ± 0.05 (.002)	See Table 2 for Thickness	0.30 (.012) ± 0.10 (.004)	0.30 (.012)	Solder Reflow Only
0603	1608	1.60 (.063) ± 0.15 (.006)	0.80 (.032) ± 0.15 (.006)		0.35 (.014) ± 0.15 (.006)	0.70 (.028)	Solder Wave or Solder Reflow
0805	2012	2.00 (.079) ± 0.20 (.008)	1.25 (.049) ± 0.20 (.008)		0.50 (0.02) ± 0.25 (.010)	0.75 (.030)	
1206	3216	3.20 (.126) ± 0.20 (.008)	1.60 (.063) ± 0.20 (.008)		0.50 (0.02) ± 0.25 (.010)	N/A	Solder Reflow Only
1210 ¹	3225	3.20 (.126) ± 0.20 (.008)	2.50 (.098) ± 0.20 (.008)		0.50 (0.02) ± 0.25 (.010)		
1812	4532	4.50 (.177) ± 0.30 (.012)	3.20 (.126) ± 0.30 (.012)		0.60 (.024) ± 0.35 (.014)		
2220	5650	5.70 (.224) ± 0.40 (.016)	5.00 (.197) ± 0.40 (.016)		0.60 (.024) ± 0.35 (.014)		

¹ For capacitance values ≥ 12 μF add 0.02 (0.001) to the width tolerance dimension

Benefits

- -55°C to +125°C operating temperature range
- Pb-Free and RoHS Compliant
- Voltage conditioning and post-electrical testing per MIL-PRF-55681
- Destructive Physical Analysis (DPA) per EIA-469
- Biased humidity testing (85/85) per MIL-STD-202
- Certificate of Compliance
- Temperature stable dielectric
- EIA 0402, 0603, 0805, 1206, 1210, 1812, and 2220 case sizes
- DC voltage ratings of 6.3 V, 10 V, 16 V, 25 V, 50 V, 100 V, 200 V, and 250 V
- Capacitance offerings ranging from 10 pF to 22 μF
- Available capacitance tolerances of ±5%, ±10%, and ±20%
- Non-polar device, minimizing installation concerns
- 100% pure matte tin-plated termination finish allowing for excellent solderability
- SnPb termination finish option available upon request (5% minimum)

Applications

Typical applications include military, space quality and high reliability electronics.

Qualification/Certification

Commercial Grade products are subject to internal qualification. Details regarding test methods and conditions are referenced in Table 4, Performance & Reliability.

Environmental Compliance

Pb-Free and RoHS Compliant (excluding SnPb termination finish option).



RoHS Compliant

Electrical Parameters/Characteristics

Item	Parameters/Characteristics
Operating Temperature Range	-55°C to +125°C
Capacitance Change with Reference to +25°C and 0 VDC Applied (TCC)	±15%
Aging Rate (Maximum % Capacitance Loss/Decade Hour)	3.0%
Dielectric Withstanding Voltage (DWV)	250% of rated voltage (5 ±1 seconds and charge/discharge not exceeding 50 mA)
Dissipation Factor (DF) Maximum Limit @ 25°C	5% (6.3 and 10 V), 3.5% (16 and 25 V) and 2.5% (50 V to 250 V)
Insulation Resistance (IR) Limit @ 25°C	See Insulation Resistance Limit Table (Rated voltage applied for 120 ±5 seconds @ 25°C)

Regarding aging rate: Capacitance measurements (including tolerance) are indexed to a referee time of 1,000 hours.

To obtain IR limit, divide $M\Omega\text{-}\mu F$ value by the capacitance and compare to $G\Omega$ limit. Select the lower of the two limits.

Capacitance and dissipation factor (DF) measured under the following conditions:

1 kHz ±50 Hz and 1.0 ±0.2 Vrms if capacitance ≤ 10 μF

120 Hz ±10 Hz and 0.5 ±0.1 Vrms if capacitance > 10 μF

Note: When measuring capacitance it is important to ensure the set voltage level is held constant. The HP4284 and Agilent E4980 have a feature known as Automatic Level Control (ALC). The ALC feature should be switched to "ON."

Post Environmental Limits

High Temperature Life, Biased Humidity, Moisture Resistance					
Dielectric	Rated DC Voltage	Capacitance Value	Dissipation Factor (Maximum %)	Capacitance Shift	Insulation Resistance
X7R	> 25	All	3.0	±20%	10% of Initial Limit
	16/25		5.0		
	< 16		7.5		

Insulation Resistance Limit Table

EIA Case Size	1,000 Megohm Microfarads or 100 GΩ	500 Megohm Microfarads or 10 GΩ
0201	N/A	ALL
0402	< 0.012 μF	≥ 0.012 μF
0603	< 0.047 μF	≥ 0.047 μF
0805	< 0.047 μF	≥ 0.047 μF
1206	< 0.22 μF	≥ 0.22 μF
1210	< 0.39 μF	≥ 0.39 μF
1808	ALL	N/A
1812	< 2.2 μF	≥ 2.2 μF
1825	ALL	N/A
2220	< 10 μF	≥ 10 μF
2225	ALL	N/A

Table 1A – Capacitance Range/Selection Waterfall (0402 – 1206 Case Sizes) cont'd

Capacitance	Cap Code	Case Size / Series	C0402C					C0603C					C0805C						C1206C													
		Voltage Code	9	8	4	3	5	9	8	4	3	5	1	2	9	8	4	3	5	1	2	A	9	8	4	3	5	1	2	A		
		Rated Voltage (VDC)	6.3	10	16	25	50	6.3	10	16	25	50	100	200	6.3	10	16	25	50	100	200	250	6.3	10	16	25	50	100	200	250		
		Capacitance Tolerance	Product Availability and Chip Thickness Codes See Table 2 for Chip Thickness Dimensions																													
5.6 µF	565	J	K	M																									EH	EH	EH	
6.8 µF	685	J	K	M																										EH	EH	EH
8.2 µF	825	J	K	M																										EH	EH	EH
10 µF	106	J	K	M																										EH	EH	EH
Capacitance	Cap Code	Rated Voltage (VDC)	6.3	10	16	25	50	6.3	10	16	25	50	100	200	6.3	10	16	25	50	100	200	250	6.3	10	16	25	50	100	200	250		
		Voltage Code	9	8	4	3	5	9	8	4	3	5	1	2	9	8	4	3	5	1	2	A	9	8	4	3	5	1	2	A		
		Series	C0402C					C0603C					C0805C						C1206C													

*Capacitance range Includes E24 decade values only. (i.e., 10, 11, 12, 13, 15, 16, 18, 20, 22, 24, 27, 30, 33, 36, 39, 43, 47, 51, 56, 62, 68, 75, 82 and 91)

**Capacitance range Includes E12 decade values only. (i.e., 10, 12, 15, 18, 22, 27, 33, 39, 47, 56, 68 and 82)

Table 1B – Capacitance Range/Selection Waterfall (1210 – 2220 Case Sizes)

Capacitance	Cap Code	Case Size / Series	C1210C								C1812C					C1825C				C2220C																										
		Voltage Code	9	8	4	3	5	1	2	A	3	5	1	2	A	5	1	2	A	3	5	1	2	A																						
		Rated Voltage (VDC)	6.3	10	16	25	50	100	200	250	25	50	100	200	250	50	100	200	250	25	50	100	200	250																						
		Capacitance Tolerance	Product Availability and Chip Thickness Codes See Table 2 for Chip Thickness Dimensions																																											
10 - 91 pF*	100 - 910*	J	K	M	FB	FB	FB	FB	FB	FB																																				
100 - 390 pF**	101 - 391**	J	K	M	FB	FB	FB	FB	FB	FB																																				
470 - 820 pF**	471 - 821**	J	K	M	FB	FB	FB	FB	FB	FB					GB	GB	GB	GB																												
560 pF	561	J	K	M	FB	FB	FB	FB	FB	FB					GB	GB	GB	GB																												
680 pF	681	J	K	M	FB	FB	FB	FB	FB	FB					GB	GB	GB	GB																												
820 pF	821	J	K	M	FB	FB	FB	FB	FB	FB					GB	GB	GB	GB																												
1,000 pF	102	J	K	M	FB	FB	FB	FB	FB	FB					GB	GB	GB	GB																												
1,200 pF	122	J	K	M	FB	FB	FB	FB	FB	FB					GB	GB	GB	GB																												
1,500 pF	152	J	K	M	FB	FB	FB	FB	FB	FB	FE				GB	GB	GB	GB																												
1,800 pF	182	J	K	M	FB	FB	FB	FB	FB	FB	FE				GB	GB	GB	GB																												
2,200 pF	222	J	K	M	FB	FB	FB	FB	FB	FB	FB				GB	GB	GB	GB																												
2,700 pF	272	J	K	M	FB	FB	FB	FB	FB	FB	FB				GB	GB	GB	GB																												
3,300 pF	332	J	K	M	FB	FB	FB	FB	FB	FB	FB				GB	GB	GB	GB																												
3,900 pF	392	J	K	M	FB	FB	FB	FB	FB	FB	FB				GB	GB	GB	GB																												
4,700 pF	472	J	K	M	FB	FB	FB	FB	FB	FB	FB				GB	GB	GB	GD																												
5,600 pF	562	J	K	M	FB	FB	FB	FB	FB	FB	FB				GB	GB	GB	GH																												
6,800 pF	682	J	K	M	FB	FB	FB	FB	FB	FB	FB				GB	GB	GB	GB	GB																											
8,200 pF	822	J	K	M	FB	FB	FB	FB	FB	FB	FB				GB	GB	GB	GB	GB																											
10,000 pF	103	J	K	M	FB	FB	FB	FB	FB	FB	FB				GB	GB	GB	GB	GB																											
Capacitance	Cap Code	Rated Voltage (VDC)	6.3	10	16	25	50	100	200	250	25	50	100	200	250	50	100	200	250	25	50	100	200	250																						
		Voltage Code	9	8	4	3	5	1	2	A	3	5	1	2	A	5	1	2	A	3	5	1	2	A																						
		Series	C1210C								C1812C					C1825C				C2220C																										

*Capacitance range Includes E24 decade values only. (i.e., 10, 11, 12, 13, 15, 16, 18, 20, 22, 24, 27, 30, 33, 36, 39, 43, 47, 51, 56, 62, 68, 75, 82 and 91)

**Capacitance range Includes E12 decade values only. (i.e., 10, 12, 15, 18, 22, 27, 33, 39, 47, 56, 68 and 82)

Table 1B – Capacitance Range/Selection Waterfall (1210 – 2220 Case Sizes) cont'd

Capacitance	Cap Code	Case Size / Series			C1210C									C1812C					C1825C				C2220C						
		Voltage Code			9	8	4	3	5	1	2	A	3	5	1	2	A	5	1	2	A	3	5	1	2	A			
		Rated Voltage (VDC)			6.3	10	16	25	50	100	200	250	25	50	100	200	250	50	100	200	250	25	50	100	200	250			
		Capacitance Tolerance			Product Availability and Chip Thickness Codes See Table 2 for Chip Thickness Dimensions																								
12,000 pF	123	J	K	M	FB	FB	FB	FB	FB	FB	FB	FB	FB	FB	GB	GB	GB	GB	GB					JE	JE	JE			
15,000 pF	153	J	K	M	FB	FB	FB	FB	FB	FB	FB	FB	FB	FB	GB	GB	GB	GB	GB					JE	JE	JE			
18,000 pF	183	J	K	M	FB	FB	FB	FB	FB	FB	FB	FB	FB	FB	GB	GB	GB	GB	GB					JE	JE	JE			
22,000 pF	223	J	K	M	FB	FB	FB	FB	FB	FB	FB	FB	FB	FB	GB	GB	GB	GB	GB	HB	HB	HB	HB	JE	JE	JE			
27,000 pF	273	J	K	M	FB	FB	FB	FB	FB	FB	FB	FB	FB	FB	GB	GB	GB	GB	GB	HB	HB	HB	HB	JE	JE	JE			
33,000 pF	333	J	K	M	FB	FB	FB	FB	FB	FB	FB	FB	FB	FB	GB	GB	GB	GB	GB	HB	HB	HB	HB	JB	JB	JB			
39,000 pF	393	J	K	M	FB	FB	FB	FB	FB	FB	FB	FB	FB	FB	GB	GB	GB	GB	GB	HB	HB	HB	HB	JB	JB	JB			
47,000 pF	473	J	K	M	FB	FB	FB	FB	FB	FB	FB	FB	FB	FB	GB	GB	GB	GB	GB	HB	HB	HB	HB	JB	JB	JB			
56,000 pF	563	J	K	M	FB	FB	FB	FB	FB	FB	FB	FC	FC	FC	GB	GB	GB	GB	GB	HB	HB	HB	HB	JB	JB	JB			
68,000 pF	683	J	K	M	FB	FB	FB	FB	FB	FB	FC	FC	FC	FC	GB	GB	GB	GB	GB	HB	HB	HB	HB	JB	JB	JB			
82,000 pF	823	J	K	M	FB	FB	FB	FB	FB	FC	FC	FC	FC	FC	GB	GB	GB	GB	GB	HB	HB	HB	HB	JB	JB	JC	JC	JC	
0.10 µF	104	J	K	M	FB	FB	FB	FB	FB	FD	FD	FD	FD	FD	GB	GB	GB	GB	GB	HB	HB	HB	HB	JB	JB	JC	JC	JC	
0.12 µF	124	J	K	M	FB	FB	FB	FB	FB	FD	FD	FD	FD	FD	GB	GB	GB	GB	GB	HB	HB	HB	HB	JB	JB	JC	JC	JC	
0.15 µF	154	J	K	M	FC	FC	FC	FC	FC	FD	FD	FD	FD	FD	GB	GB	GB	GE	GE	HB	HB	HB	HB	JB	JB	JC	JC	JC	
0.18 µF	184	J	K	M	FC	FC	FC	FC	FC	FD	FD	FD	FD	FD	GB	GB	GB	GG	GG	HB	HB	HB	HB	JB	JB	JC	JC	JC	
0.22 µF	224	J	K	M	FC	FC	FC	FC	FC	FD	FD	FD	FD	FD	GB	GB	GB	GG	GG	HB	HB	HB	HB	JB	JB	JC	JC	JC	
0.27 µF	274	J	K	M	FC	FC	FC	FC	FC	FD	FD	FD	FD	FD	GB	GB	GG	GG	GG	HB	HB	HB	HB	JC	JC	JC	JC	JC	
0.33 µF	334	J	K	M	FD	FD	FD	FD	FD	FD	FD	FD	FD	FD	GB	GB	GG	GG	GG	HB	HB	HB	HB	JC	JC	JC	JC	JC	
0.39 µF	394	J	K	M	FD	FD	FD	FD	FD	FD	FD	FD	FD	FD	GB	GB	GG	GG	GG	HD	HD	HD	HD	JC	JC	JC	JC	JC	
0.47 µF	474	J	K	M	FD	FD	FD	FD	FD	FD	FD	FD	FD	FD	GB	GB	GG	GJ	GJ	HD	HD	HD	HD	JC	JC	JC	JC	JC	
0.56 µF	564	J	K	M	FD	FD	FD	FD	FD	FF	FF	FF	FF	FF	GC	GC	GG			HD	HD	HD	HD	JC	JD	JD	JD	JD	
0.68 µF	684	J	K	M	FD	FD	FD	FD	FD	FG	FG	FG	FG	FG	GC	GC	GG			HD	HD	HD	HD	JC	JD	JD	JD	JD	
0.82 µF	824	J	K	M	FF	FF	FF	FF	FF	FL	FL	FL	FL	FL	GE	GE	GG			HF	HF	HF	HF	JC	JF	JF	JF	JF	
1.0 µF	105	J	K	M	FH	FH	FH	FH	FH	FM	FM	FM	FM	FM	GE	GE	GG			HF	HF	HF	HF	JC	JF	JF	JF	JF	
1.2 µF	125	J	K	M	FH	FH	FH	FH	FG														JC	JC					
1.5 µF	155	J	K	M	FH	FH	FH	FH	FG														JC	JC					
1.8 µF	185	J	K	M	FH	FH	FH	FH	FG														JC	JC					
2.2 µF	225	J	K	M	FJ	FJ	FJ	FJ	FG						GO	GO							JD	JD					
2.7 µF	275	J	K	M	FE	FE	FE	FG	FH														JF	JF					
3.3 µF	335	J	K	M	FF	FF	FF	FM	FM																				
3.9 µF	395	J	K	M	FG	FG	FG	FG	FK																				
4.7 µF	475	J	K	M	FC	FC	FC	FG	FS						GK	GK								JF	JF				
5.6 µF	565	J	K	M	FF	FF	FF	FH																					
6.8 µF	685	J	K	M	FG	FG	FG	FM																					
8.2 µF	825	J	K	M	FH	FH	FH	FK																					
10 µF	106	J	K	M	FH	FH	FH	FS							GK									JF	JO				
15 µF	156	J	K	M																				JO					
22 µF	226	J	K	M	FS	FS																		JO					
Capacitance	Cap Code	Rated Voltage (VDC)			6.3	10	16	25	50	100	200	250	25	50	100	200	250	50	100	200	250	25	50	100	200	250			
		Voltage Code			9	8	4	3	5	1	2	A	3	5	1	2	A	5	1	2	A	3	5	1	2	A			
		Series			C1210C									C1812C					C1825C				C2220C						

*Capacitance range Includes E24 decade values only. (i.e., 10, 11, 12, 13, 15, 16, 18, 20, 22, 24, 27, 30, 33, 36, 39, 43, 47, 51, 56, 62, 68, 75, 82 and 91)

**Capacitance range Includes E12 decade values only. (i.e., 10, 12, 15, 18, 22, 27, 33, 39, 47, 56, 68 and 82)

Table 2 – Chip Thickness/Packaging Quantities

Thickness Code	Case Size	Thickness ± Range (mm)	Paper Quantity		Plastic Quantity	
			7" Reel	13" Reel	7" Reel	13" Reel
BB	0402	0.50 ± 0.05	10,000	50,000	0	0
CB	0603	0.80 ± 0.07	4,000	10,000	0	0
CF	0603	0.80 ± 0.07*	4,000	15,000	0	0
DE	0805	0.70 ± 0.20	4,000	10,000	0	0
DC	0805	0.78 ± 0.10	4,000	10,000	0	0
DD	0805	0.90 ± 0.10	4,000	10,000	0	0
DG	0805	1.25 ± 0.15	0	0	2,500	10,000
DH	0805	1.25 ± 0.20	0	0	2,500	10,000
EB	1206	0.78 ± 0.10	4,000	10,000	4,000	10,000
EC	1206	0.90 ± 0.10	0	0	4,000	10,000
EN	1206	0.95 ± 0.10	0	0	4,000	10,000
ED	1206	1.00 ± 0.10	0	0	2,500	10,000
EE	1206	1.10 ± 0.10	0	0	2,500	10,000
EF	1206	1.20 ± 0.15	0	0	2,500	10,000
EM	1206	1.25 ± 0.15	0	0	2,500	10,000
EG	1206	1.60 ± 0.15	0	0	2,000	8,000
EH	1206	1.60 ± 0.20	0	0	2,000	8,000
FB	1210	0.78 ± 0.10	0	0	4,000	10,000
FC	1210	0.90 ± 0.10	0	0	4,000	10,000
FD	1210	0.95 ± 0.10	0	0	4,000	10,000
FE	1210	1.00 ± 0.10	0	0	2,500	10,000
FF	1210	1.10 ± 0.10	0	0	2,500	10,000
FG	1210	1.25 ± 0.15	0	0	2,500	10,000
FL	1210	1.40 ± 0.15	0	0	2,000	8,000
FH	1210	1.55 ± 0.15	0	0	2,000	8,000
FM	1210	1.70 ± 0.20	0	0	2,000	8,000
FJ	1210	1.85 ± 0.20	0	0	2,000	8,000
FK	1210	2.10 ± 0.20	0	0	2,000	8,000
FS	1210	2.50 ± 0.30	0	0	1,000	4,000
GB	1812	1.00 ± 0.10	0	0	1,000	4,000
GC	1812	1.10 ± 0.10	0	0	1,000	4,000
GD	1812	1.25 ± 0.15	0	0	1,000	4,000
GE	1812	1.30 ± 0.10	0	0	1,000	4,000
GH	1812	1.40 ± 0.15	0	0	1,000	4,000
GG	1812	1.55 ± 0.10	0	0	1,000	4,000
GK	1812	1.60 ± 0.20	0	0	1,000	4,000
GJ	1812	1.70 ± 0.15	0	0	1,000	4,000
GO	1812	2.50 ± 0.20	0	0	500	2,000
HB	1825	1.10 ± 0.15	0	0	1,000	4,000
HD	1825	1.30 ± 0.15	0	0	1,000	4,000
HF	1825	1.50 ± 0.15	0	0	1,000	4,000
JB	2220	1.00 ± 0.15	0	0	1,000	4,000
JC	2220	1.10 ± 0.15	0	0	1,000	4,000
JD	2220	1.30 ± 0.15	0	0	1,000	4,000
JE	2220	1.40 ± 0.15	0	0	1,000	4,000
JF	2220	1.50 ± 0.15	0	0	1,000	4,000
JO	2220	2.40 ± 0.15	0	0	500	2,000
Thickness Code	Case Size	Thickness ± Range (mm)	7" Reel	13" Reel	7" Reel	13" Reel
			Paper Quantity		Plastic Quantity	

Package quantity based on finished chip thickness specifications.

Table 3 – Chip Capacitor Land Pattern Design Recommendations per IPC–7351

EIA Size Code	Metric Size Code	Density Level A: Maximum (Most) Land Protrusion (mm)					Density Level B: Median (Nominal) Land Protrusion (mm)					Density Level C: Minimum (Least) Land Protrusion (mm)				
		C	Y	X	V1	V2	C	Y	X	V1	V2	C	Y	X	V1	V2
0402	1005	0.50	0.72	0.72	2.20	1.20	0.45	0.62	0.62	1.90	1.00	0.40	0.52	0.52	1.60	0.80
0603	1608	0.90	1.15	1.10	4.00	2.10	0.80	0.95	1.00	3.10	1.50	0.60	0.75	0.90	2.40	1.20
0805	2012	1.00	1.35	1.55	4.40	2.60	0.90	1.15	1.45	3.50	2.00	0.75	0.95	1.35	2.80	1.70
1206	3216	1.60	1.35	1.90	5.60	2.90	1.50	1.15	1.80	4.70	2.30	1.40	0.95	1.70	4.00	2.00
1210	3225	1.60	1.35	2.80	5.65	3.80	1.50	1.15	2.70	4.70	3.20	1.40	0.95	2.60	4.00	2.90
1210 ¹	3225	1.50	1.60	2.90	5.60	3.90	1.40	1.40	2.80	4.70	3.30	1.30	1.20	2.70	4.00	3.00
1812	4532	2.15	1.60	3.60	6.90	4.60	2.05	1.40	3.50	6.00	4.00	1.95	1.20	3.40	5.30	3.70
2220	5650	2.75	1.70	5.50	8.20	6.50	2.65	1.50	5.40	7.30	5.90	2.55	1.30	5.30	6.60	5.60

¹ Only for capacitance values $\geq 22 \mu\text{F}$

Density Level A: For low-density product applications. Recommended for wave solder applications and provides a wider process window for reflow solder processes. KEMET only recommends wave soldering of EIA 0603, 0805, and 1206 case sizes.

Density Level B: For products with a moderate level of component density. Provides a robust solder attachment condition for reflow solder processes.

Density Level C: For high component density product applications. Before adapting the minimum land pattern variations the user should perform qualification testing based on the conditions outlined in IPC Standard 7351 (IPC–7351).

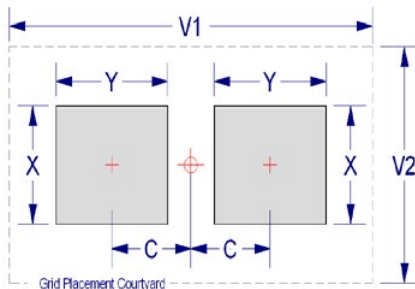

Soldering Process

Recommended Soldering Technique:

- Solder wave or solder reflow for EIA case sizes 0603, 0805 and 1206
- All other EIA case sizes are limited to solder reflow only

Recommended Reflow Soldering Profile:

KEMET's families of surface mount multilayer ceramic capacitors (SMD MLCCs) are compatible with wave (single or dual), convection, IR or vapor phase reflow techniques. Preheating of these components is recommended to avoid extreme thermal stress. KEMET's recommended profile conditions for convection and IR reflow reflect the profile conditions of the IPC/J-STD-020 standard for moisture sensitivity testing. These devices can safely withstand a maximum of three reflow passes at these conditions.

Profile Feature	Termination Finish	
	SnPb	100% Matte Sn
Preheat/Soak		
Temperature Minimum (T_{Smin})	100°C	150°C
Temperature Maximum (T_{Smax})	150°C	200°C
Time (t_s) from T_{Smin} to T_{Smax}	60 – 120 seconds	60 – 120 seconds
Ramp-Up Rate (T_L to T_p)	3°C/second maximum	3°C/second maximum
Liquidous Temperature (T_L)	183°C	217°C
Time Above Liquidous (t_L)	60 – 150 seconds	60 – 150 seconds
Peak Temperature (T_p)	235°C	260°C
Time Within 5°C of Maximum Peak Temperature (t_p)	20 seconds maximum	30 seconds maximum
Ramp-Down Rate (T_p to T_L)	6°C/second maximum	6°C/second maximum
Time 25°C to Peak Temperature	6 minutes maximum	8 minutes maximum

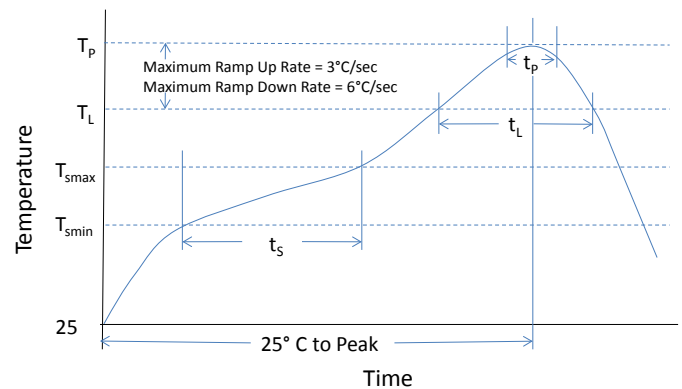

Note 1: All temperatures refer to the center of the package, measured on the capacitor body surface that is facing up during assembly reflow.

Table 4 – Performance & Reliability: Test Methods and Conditions

Stress	Reference	Test or Inspection Method
Terminal Strength	JIS-C-6429	Appendix 1, Note: Force of 1.8 kg for 60 seconds.
Board Flex	JIS-C-6429	Appendix 2, Note: Standard termination system – 2.0 mm (minimum) for all except 3 mm for COG. Flexible termination system – 3.0 mm (minimum).
Solderability	J-STD-002	Magnification 50 X. Conditions:
		a) Method B, 4 hours @ 155°C, dry heat @ 235°C
		b) Method B @ 215°C category 3
		c) Method D, category 3 @ 260°C
Temperature Cycling	JESD22 Method JA-104	1,000 Cycles (-55°C to +125°C). Measurement at 24 hours +/- 2 hours after test conclusion.
Biased Humidity	MIL-STD-202 Method 103	Load Humidity: 1,000 hours 85°C/85% RH and rated voltage. Add 100 K ohm resistor. Measurement at 24 hours +/- 2 hours after test conclusion.
		Low Volt Humidity: 1,000 hours 85°C/85% RH and 1.5 V. Add 100 K ohm resistor. Measurement at 24 hours +/- 2 hours after test conclusion.
Moisture Resistance	MIL-STD-202 Method 106	t = 24 hours/cycle. Steps 7a and 7b not required. Unpowered. Measurement at 24 hours +/- 2 hours after test conclusion.
Thermal Shock	MIL-STD-202 Method 107	-55°C/+125°C. Note: Number of cycles required – 300, maximum transfer time – 20 seconds, dwell time – 15 minutes. Air – Air.
High Temperature Life	MIL-STD-202 Method 108 /EIA-198	1,000 hours at 125°C (85°C for X5R, Z5U and Y5V) with 2 X rated voltage applied.
Storage Life	MIL-STD-202 Method 108	150°C, 0 VDC for 1,000 hours.
Vibration	MIL-STD-202 Method 204	5 g's for 20 min., 12 cycles each of 3 orientations. Note: Use 8" X 5" PCB 0.031" thick 7 secure points on one long side and 2 secure points at corners of opposite sides. Parts mounted within 2" from any secure point. Test from 10 – 2,000 Hz
Mechanical Shock	MIL-STD-202 Method 213	Figure 1 of Method 213, Condition F.
Resistance to Solvents	MIL-STD-202 Method 215	Add aqueous wash chemical, OKEM Clean or equivalent.

Storage & Handling

Ceramic chip capacitors should be stored in normal working environments. While the chips themselves are quite robust in other environments, solderability will be degraded by exposure to high temperatures, high humidity, corrosive atmospheres, and long term storage. In addition, packaging materials will be degraded by high temperature– reels may soften or warp and tape peel force may increase. KEMET recommends that maximum storage temperature not exceed 40°C and maximum storage humidity not exceed 70% relative humidity. Temperature fluctuations should be minimized to avoid condensation on the parts and atmospheres should be free of chlorine and sulfur bearing compounds. For optimized solderability chip stock should be used promptly, preferably within 1.5 years of receipt.

High Temperature 150°C, Ultra-Stable X8R Dielectric, 25 – 100 VDC (Commercial & Automotive Grade)

Overview

KEMET's Ultra-Stable X8R dielectric features a 150°C maximum operating temperature, offering the latest in high temperature dielectric technology and reliability for extreme temperature applications. It offers the same temperature capability as conventional X8R, but without the capacitance loss due to applied DC voltage. Ultra-Stable X8R exhibits no change in capacitance with respect to voltage and boasts a minimal change in capacitance with reference to ambient temperature. It is a suitable replacement for higher capacitance and larger footprint devices that fail to offer capacitance stability. Capacitance change with respect to temperature is limited to $\pm 15\%$ from -55°C to +150°C.

Driven by the demand for a more robust and reliable component, Ultra-Stable X8R dielectric capacitors were developed for critical applications where reliability and capacitance stability at higher operating temperatures are a concern. These capacitors are widely used in automotive circuits as well as general high temperature applications.

In addition to commercial grade, automotive grade devices are available and meet the demanding Automotive Electronics Council's AEC-Q200 qualification requirements.

Benefits

- -55°C to +150°C operating temperature range
- Pb-Free and RoHS Compliant
- EIA 0402, 0603, 0805, 1206, 1210, and 1812 case sizes
- DC voltage ratings of 25 V, 50 V, and 100 V
- Capacitance offerings ranging from 10 pF to 0.22 μ F
- Available capacitance tolerances of $\pm 1\%$, $\pm 2\%$, $\pm 5\%$, $\pm 10\%$, and $\pm 20\%$
- Extremely low ESR and ESL
- High thermal stability
- High ripple current capability
- No capacitance change with respect to applied rated DC voltage
- Non-polar device, minimizing installation concerns
- Offered in both commercial and automotive grades
- 100% pure matte tin-plated termination finish that allowing for excellent solderability.
- SnPb plated termination finish option available upon request (5% minimum)

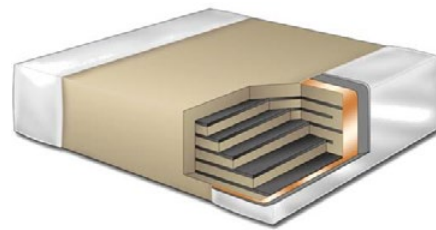

Ordering Information

C	1210	C	184	K	3	H	A	C	AUTO
Ceramic	Case Size (L" x W")	Specification/ Series ¹	Capacitance Code (pF)	Capacitance Tolerance	Voltage	Dielectric	Failure Rate/ Design	Termination Finish ²	Packaging/Grade (C-Spec) ²
	0402 0603 0805 1206 1210 1812	C = Standard	2 Significant Digits + Number of Zeros	F = $\pm 1\%$ G = $\pm 2\%$ J = $\pm 5\%$ K = $\pm 10\%$ M = $\pm 20\%$	3 = 25 V 5 = 50 V 1 = 100 V	H = Ultra Stable X8R	A = N/A	C = 100% Matte Sn L = SnPb (5% minimum)	Blank = Bulk TU = 7" Reel Unmarked AUTO = Automotive Grade 7" Reel Unmarked

¹ Flexible termination option is available. Please see FT-CAP product bulletin C1013_X8R_FT-CAP_SMD

² Additional termination finish options may be available. Contact KEMET for details.

^{2,3} SnPb termination finish option is not available on automotive grade product.

³ Additional reeling or packaging options may be available. Contact KEMET for details.

Dimensions – Millimeters (Inches)

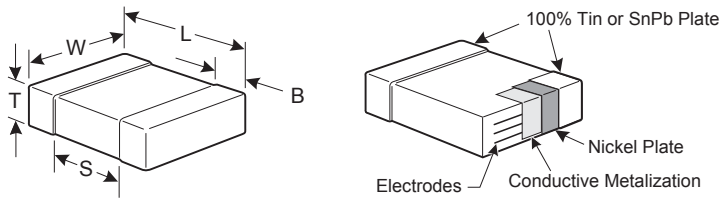

EIA Size Code	Metric Size Code	L Length	W Width	T Thickness	B Bandwidth	S Separation Minimum	Mounting Technique
0402	1005	1.00 (.040) ± 0.05 (.002)	0.50 (.020) ± 0.05 (.002)	See Table 2 for Thickness	0.30 (.012) ± 0.10 (.004)	0.30 (.012)	Solder Reflow Only
0603	1608	1.60 (.063) ± 0.15 (.006)	0.80 (.032) ± 0.15 (.006)		0.35 (.014) ± 0.15 (.006)	0.70 (.028)	Solder Wave or Solder Reflow
0805	2012	2.00 (.079) ± 0.20 (.008)	1.25 (.049) ± 0.20 (.008)		0.50 (0.02) ± 0.25 (.010)	0.75 (.030)	
1206	3216	3.20 (.126) ± 0.20 (.008)	1.60 (.063) ± 0.20 (.008)		0.50 (0.02) ± 0.25 (.010)	N/A	Solder Reflow Only
1210	3225	3.20 (.126) ± 0.20 (.008)	2.50 (.098) ± 0.20 (.008)		0.50 (0.02) ± 0.25 (.010)		
1812	4532	4.50 (.177) ± 0.30 (.012)	3.20 (.126) ± 0.30 (.012)		0.60 (.024) ± 0.35 (.014)		

Applications

Typical applications include decoupling, bypass and filtering in extreme environments such as down-hole oil exploration, under-hood automotive, military and aerospace.

Qualification/Certification

Commercial Grade products are subject to internal qualification. Details regarding test methods and conditions are referenced in Table 4, Performance & Reliability.

Automotive Grade products meet or exceed the requirements outlined by the Automotive Electronics Council. Details regarding test methods and conditions are referenced in document AEC-Q200, Stress Test Qualification for Passive Components. For additional information regarding the Automotive Electronics Council and AEC-Q200, please visit their website at www.aecouncil.com.

Environmental Compliance

Pb-Free and RoHS Compliant (excluding SnPb termination finish option).



RoHS Compliant

Electrical Parameters/Characteristics

Item	Parameters/Characteristics
Operating Temperature Range	-55°C to +150°C
Capacitance Change with Reference to +25°C and 0 VDC Applied (TCC)	±15%
Aging Rate (Maximum % Capacitance Loss/Decade Hour)	0%
Dielectric Withstanding Voltage (DWV)	250% of rated voltage (5 ±1 seconds and charge/discharge not exceeding 50 mA)
Dissipation Factor (DF) Maximum Limit @ 25°C	2.5%
Insulation Resistance (IR) Limit @ 25°C	1,000 megohm microfarads or 100 GΩ (Rated voltage applied for 120 ±5 seconds @ 25°C)

To obtain IR limit, divide $M\Omega\text{-}\mu F$ value by the capacitance and compare to $G\Omega$ limit. Select the lower of the two limits.

Capacitance and dissipation factor (DF) measured under the following conditions:

1 MHz ±100 kHz and 1.0 ±0.2 Vrms if capacitance ≤ 1,000 pF.

1 kHz ±50 Hz and 1.0 ±0.2 Vrms if capacitance > 1,000 pF

Note: When measuring capacitance it is important to ensure the set voltage level is held constant. The HP4284 and Agilent E4980 have a feature known as Automatic Level Control (ALC). The ALC feature should be switched to "ON."

Post Environmental Limits

High Temperature Life, Biased Humidity, Moisture Resistance					
Dielectric	Rated DC Voltage	Capacitance Value	Dissipation Factor (Maximum %)	Capacitance Shift	Insulation Resistance
Ultra-Stable X8R	All	All	2.5	0.3% or ±0.25 pf	10% of Initial Limit

Table 1 – Capacitance Range/Selection Waterfall (0402 – 1812 Case Sizes)

Capacitance	Cap Code	Case Size / Series					C0402C			C0603C			C0805C			C1206C			C1210C			C1812C		
		Voltage Code					3	5	1	3	5	1	3	5	1	3	5	1	3	5	1	5	1	
		Rated Voltage (VDC)					25	50	100	25	50	100	25	50	100	25	50	100	25	50	100	50	100	
		Capacitance Tolerance					Product Availability and Chip Thickness Codes See Table 2 for Chip Thickness Dimensions																	
100 pF	101	F	G	J	K	M	BB	BB	BB															
110 pF	111	F	G	J	K	M	BB	BB	BB															
120 pF	121	F	G	J	K	M	BB	BB	BB															
130 pF	131	F	G	J	K	M	BB	BB	BB															
150 pF	151	F	G	J	K	M	BB	BB	BB															
160 pF	161	F	G	J	K	M	BB	BB	BB															
180 pF	181	F	G	J	K	M	BB	BB	BB															
200 pF	201	F	G	J	K	M	BB	BB	BB															
220 pF	221	F	G	J	K	M	BB	BB	BB															
240 pF	241	F	G	J	K	M	BB	BB	BB															
270 pF	271	F	G	J	K	M	BB	BB	BB															
300 pF	301	F	G	J	K	M	BB	BB	BB															
330 pF	331	F	G	J	K	M	BB	BB	BB															
360 pF	361	F	G	J	K	M	BB	BB	BB															
390 pF	391	F	G	J	K	M	BB	BB	BB															
430 pF	431	F	G	J	K	M	BB	BB	BB	CB	CB	CB												
470 pF	471	F	G	J	K	M	BB	BB	BB	CB	CB	CB												
510 pF	511	F	G	J	K	M	BB	BB	BB	CB	CB	CB												
560 pF	561	F	G	J	K	M	BB	BB	BB	CB	CB	CB												
620 pF	621	F	G	J	K	M	BB	BB	BB	CB	CB	CB												
680 pF	681	F	G	J	K	M	BB	BB	BB	CB	CB	CB												
750 pF	751	F	G	J	K	M	BB	BB	BB	CB	CB	CB												
820 pF	821	F	G	J	K	M	BB	BB	BB	CB	CB	CB												
910 pF	911	F	G	J	K	M	BB	BB	BB	CB	CB	CB												
1,000 pF	102	F	G	J	K	M	BB	BB	BB	CB	CB	CB												
1,100 pF	112	F	G	J	K	M	BB	BB		CB	CB	CB												
1,200 pF	122	F	G	J	K	M	BB	BB		CB	CB	CB												
1,300 pF	132	F	G	J	K	M	BB	BB		CB	CB	CB												
1,500 pF	152	F	G	J	K	M	BB	BB		CB	CB	CB												
1,600 pF	162	F	G	J	K	M				CB	CB	CB												
1,800 pF	182	F	G	J	K	M				CB	CB	CB												
2,000 pF	202	F	G	J	K	M				CB	CB	CB	DC	DC	DC									
2,200 pF	222	F	G	J	K	M				CB	CB	CB	DC	DC	DC									
2,400 pF	242	F	G	J	K	M				CB	CB	CB	DC	DC	DC									
2,700 pF	272	F	G	J	K	M				CB	CB	CB	DC	DC	DC									
3,000 pF	302	F	G	J	K	M				CB	CB	CB	DC	DC	DC									
3,300 pF	332	F	G	J	K	M				CB	CB	CB	DC	DC	DC									
3,600 pF	362	F	G	J	K	M				CB	CB	CB	DC	DC	DC									
3,900 pF	392	F	G	J	K	M				CB	CB	CB	DC	DC	DC									
4,300 pF	432	F	G	J	K	M				CB	CB	CB	DC	DC	DC									
4,700 pF	472	F	G	J	K	M				CB	CB	CB	DC	DC	DC									
5,100 pF	512	F	G	J	K	M				CB	CB	CB	DC	DC	DC									
5,600 pF	562	F	G	J	K	M				CB	CB	CB	DC	DC	DC									
6,200 pF	622	F	G	J	K	M				CB	CB	CB	DC	DC	DC									
6,800 pF	682	F	G	J	K	M				CB	CB	CB	DC	DC	DC	EB	EB	EB						
7,500 pF	752	F	G	J	K	M				CB	CB	CB	DC	DC	DC	EB	EB	EB						
8,200 pF	822	F	G	J	K	M				CB	CB	CB	DC	DC	DC	EB	EB	EB						
9,100 pF	912	F	G	J	K	M				CB	CB	CB	DC	DC	DC	EB	EB	EB						
10,000 pF	103	F	G	J	K	M				CB	CB	CB	DC	DC	DD	EB	EB	EB						
12,000 pF	123	F	G	J	K	M							DC	DC	DE	EB	EB	EB	FB	FB	FB			
15,000 pF	153	F	G	J	K	M							DC	DD	DG	EB	EB	EB	EB	FB	FB	FB	GB	GB
18,000 pF	183	F	G	J	K	M							DC	DD		EB	EB	EB	FB	FB	FB	GB	GB	
22,000 pF	223	F	G	J	K	M							DD	DF		EB	EB	EC	FB	FB	FB	GB	GB	
27,000 pF	273	F	G	J	K	M							DF			EB	EB	EE	FB	FB	FB	GB	GB	
33,000 pF	333	F	G	J	K	M							DG			EB	EB	EE	FB	FB	FB	GB	GB	
Capacitance	Cap Code	Rated Voltage (VDC)					25	50	100	25	50	100	25	50	100	25	50	100	25	50	100	50	100	
		Voltage Code					3	5	1	3	5	1	3	5	1	3	5	1	3	5	1	5	1	
		Case Size / Series					C0402C			C0603C			C0805C			C1206C			C1210C			C1812C		

Table 1 – Capacitance Range/Selection Waterfall (0402 – 1812 Case Sizes) cont'd

Capacitance	Cap Code	Case Size / Series	C0402C			C0603C			C0805C			C1206C			C1210C			C1812C	
		Voltage Code	3	5	1	3	5	1	3	5	1	3	5	1	3	5	1	5	1
		Rated Voltage (VDC)	25	50	100	25	50	100	25	50	100	25	50	100	25	50	100	50	100
		Capacitance Tolerance	Product Availability and Chip Thickness Codes See Table 2 for Chip Thickness Dimensions																
47,000 pF	473	F G J K M										EC	EE	EH	FB	FB	FE	GB	GB
56,000 pF	563	F G J K M										ED	EF	EH	FB	FB	FF	GB	GB
68,000 pF	683	F G J K M										EF	EH		FB	FC	FG	GB	GB
82,000 pF	823	F G J K M										EH	EH		FC	FF	FH	GB	GB
100,000 pF	104	F G J K M										EH			FE	FG	FM	GB	GD
120,000 pF	124	F G J K M													FG	FH		GB	GH
150,000 pF	154	F G J K M													FH	FM		GD	GN
180,000 pF	184	F G J K M													FJ			GH	
220,000 pF	224	F G J K M																GK	
Capacitance	Cap Code	Rated Voltage (VDC)	25	50	100	25	50	100	25	50	100	25	50	100	25	50	100	50	100
		Voltage Code	3	5	1	3	5	1	3	5	1	3	5	1	3	5	1	5	1
		Case Size / Series	C0402C			C0603C			C0805C			C1206C			C1210C			C1812C	

Table 2 – Chip Thickness/Packaging Quantities

Thickness Code	Case Size	Thickness ± Range (mm)	Paper Quantity		Plastic Quantity	
			7" Reel	13" Reel	7" Reel	13" Reel
BB	0402	0.50 ± 0.05	10,000	50,000	0	0
CB	0603	0.80 ± 0.07	4,000	10,000	0	0
DC	0805	0.78 ± 0.10	4,000	10,000	0	0
DD	0805	0.90 ± 0.10	4,000	10,000	0	0
DE	0805	1.00 ± 0.10	0	0	2,500	10,000
DF	0805	1.10 ± 0.10	0	0	2,500	10,000
DG	0805	1.25 ± 0.15	0	0	2,500	10,000
EB	1206	0.78 ± 0.10	4,000	10,000	4,000	10,000
EC	1206	0.90 ± 0.10	0	0	4,000	10,000
ED	1206	1.00 ± 0.10	0	0	2,500	10,000
EE	1206	1.10 ± 0.10	0	0	2,500	10,000
EF	1206	1.20 ± 0.15	0	0	2,500	10,000
EH	1206	1.60 ± 0.20	0	0	2,000	8,000
FB	1210	0.78 ± 0.10	0	0	4,000	10,000
FC	1210	0.90 ± 0.10	0	0	4,000	10,000
FE	1210	1.00 ± 0.10	0	0	2,500	10,000
FF	1210	1.10 ± 0.10	0	0	2,500	10,000
FG	1210	1.25 ± 0.15	0	0	2,500	10,000
FH	1210	1.55 ± 0.15	0	0	2,000	8,000
FM	1210	1.70 ± 0.20	0	0	2,000	8,000
FJ	1210	1.85 ± 0.20	0	0	2,000	8,000
GB	1812	1.00 ± 0.10	0	0	1,000	4,000
GD	1812	1.25 ± 0.15	0	0	1,000	4,000
GH	1812	1.40 ± 0.15	0	0	1,000	4,000
GK	1812	1.60 ± 0.20	0	0	1,000	4,000
GN	1812	1.70 ± 0.20	0	0	1,000	4,000
Thickness Code	Case Size	Thickness ± Range (mm)	7" Reel	13" Reel	7" Reel	13" Reel
			Paper Quantity		Plastic Quantity	

Package quantity based on finished chip thickness specifications.

Table 3 – Chip Capacitor Land Pattern Design Recommendations per IPC–7351

EIA Size Code	Metric Size Code	Density Level A: Maximum (Most) Land Protrusion (mm)					Density Level B: Median (Nominal) Land Protrusion (mm)					Density Level C: Minimum (Least) Land Protrusion (mm)				
		C	Y	X	V1	V2	C	Y	X	V1	V2	C	Y	X	V1	V2
0402	1005	0.50	0.72	0.72	2.20	1.20	0.45	0.62	0.62	1.90	1.00	0.40	0.52	0.52	1.60	0.80
0603	1608	0.90	1.15	1.10	4.00	2.10	0.80	0.95	1.00	3.10	1.50	0.60	0.75	0.90	2.40	1.20
0805	2012	1.00	1.35	1.55	4.40	2.60	0.90	1.15	1.45	3.50	2.00	0.75	0.95	1.35	2.80	1.70
1206	3216	1.60	1.35	1.90	5.60	2.90	1.50	1.15	1.80	4.70	2.30	1.40	0.95	1.70	4.00	2.00
1210	3225	1.60	1.35	2.80	5.65	3.80	1.50	1.15	2.70	4.70	3.20	1.40	0.95	2.60	4.00	2.90
1210 ¹	3225	1.50	1.60	2.90	5.60	3.90	1.40	1.40	2.80	4.70	3.30	1.30	1.20	2.70	4.00	3.00
1812	4532	2.15	1.60	3.60	6.90	4.60	2.05	1.40	3.50	6.00	4.00	1.95	1.20	3.40	5.30	3.70

¹ Only for capacitance values $\geq 22 \mu\text{F}$

Density Level A: For low-density product applications. Recommended for wave solder applications and provides a wider process window for reflow solder processes. KEMET only recommends wave soldering of EIA 0603, 0805 and 1206 case sizes.

Density Level B: For products with a moderate level of component density. Provides a robust solder attachment condition for reflow solder processes.

Density Level C: For high component density product applications. Before adapting the minimum land pattern variations the user should perform qualification testing based on the conditions outlined in IPC Standard 7351 (IPC–7351).

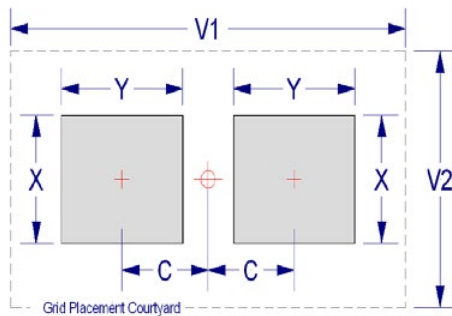

Soldering Process

Recommended Soldering Technique:

- Solder wave or solder reflow for EIA case sizes 0603, 0805 and 1206
- All other EIA case sizes are limited to solder reflow only

Recommended Soldering Profile:

- KEMET recommends following the guidelines outlined in IPC/JEDEC J–STD–020

Table 4 – Performance & Reliability: Test Methods and Conditions

Stress	Reference	Test or Inspection Method
Terminal Strength	JIS-C-6429	Appendix 1, Note: Force of 1.8 kg for 60 seconds.
Board Flex	JIS-C-6429	Appendix 2, Note: Standard termination system – 2.0 mm (minimum) for all except 3 mm for COG. Flexible termination system – 3.0 mm (minimum).
Solderability	J-STD-002	Magnification 50 X. Conditions:
		a) Method B, 4 hours @ 155°C, dry heat @ 235°C
		b) Method B @ 215°C category 3
		c) Method D, category 3 @ 260°C
Temperature Cycling	JESD22 Method JA-104	1,000 cycles (-55°C to +150°C). Measurement at 24 hours +/- 2 hours after test conclusion.
Biased Humidity	MIL-STD-202 Method 103	Load Humidity: 1,000 hours 85°C/85%RH and rated voltage. Add 100K ohm resistor. Measurement at 24 hours +/- 2 hours after test conclusion.
		Low Volt Humidity: 1,000 hours 85°C/85% RH and 1.5 V. Add 100 K ohm resistor. Measurement at 24 hours +/- 2 hours after test conclusion.
Moisture Resistance	MIL-STD-202 Method 106	t = 24 hours/cycle. Steps 7a and 7b not required. Unpowered. Measurement at 24 hours. +/- 2 hours after test conclusion.
Thermal Shock	MIL-STD-202 Method 107	-55°C/+150. Note: Number of cycles required – 300. Maximum transfer time – 20 seconds. Dwell time – 15 minutes. Air – Air.
High Temperature Life	MIL-STD-202 Method 108 /EIA-198	1,000 hours at 150°C with 2 X rated voltage applied.
Storage Life	MIL-STD-202 Method 108	150°C, 0 VDC for 1,000 hours.
Vibration	MIL-STD-202 Method 204	5 g's for 20 min., 12 cycles each of 3 orientations. Note: Use 8" X 5" PCB 0.031" thick 7 secure points on one long side and 2 secure points at corners of opposite sides. Parts mounted within 2" from any secure point. Test from 10 – 2,000 Hz
Mechanical Shock	MIL-STD-202 Method 213	Figure 1 of Method 213, Condition F.
Resistance to Solvents	MIL-STD-202 Method 215	Add aqueous wash chemical, OKEM Clean or equivalent.

Storage and Handling

Ceramic chip capacitors should be stored in normal working environments. While the chips themselves are quite robust in other environments, solderability will be degraded by exposure to high temperatures, high humidity, corrosive atmospheres, and long term storage. In addition, packaging materials will be degraded by high temperature– reels may soften or warp and tape peel force may increase. KEMET recommends that maximum storage temperature not exceed 40°C and maximum storage humidity not exceed 70% relative humidity. Temperature fluctuations should be minimized to avoid condensation on the parts and atmospheres should be free of chlorine and sulfur bearing compounds. For optimized solderability chip stock should be used promptly, preferably within 1.5 years of receipt.

Construction

Reference	Item		Material	
A	Termination System	Finish	100% Matte Sn	SnPb (5% min)
B		Barrier Layer	Ni	
C		Base Metal	Cu	
D	Inner Electrode		Ni	
E	Dielectric Material		CaZrO ₃	

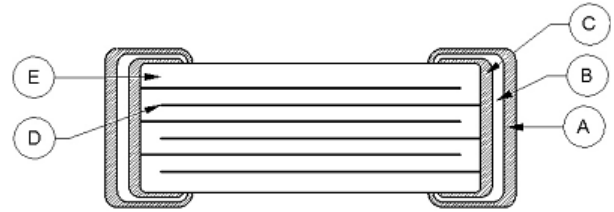

Note: Image is exaggerated in order to clearly identify all components of construction.

Capacitor Marking (Optional):

Laser marking option is not available on:

- COG, Ultra Stable X8R and Y5V dielectric devices
- EIA 0402 case size devices
- EIA 0603 case size devices with Flexible Termination option.
- KPS Commercial and Automotive grade stacked devices.

These capacitors are supplied unmarked only.

High Temperature 150°C, X8L Dielectric, 10 – 50 VDC (Commercial & Automotive Grade)

Overview

KEMET's X8L dielectric features a 150°C maximum operating temperature and is considered "general purpose high temperature." These components are fixed, ceramic dielectric capacitors suited for high temperature bypass and decoupling applications or frequency discriminating circuits where Q and stability of capacitance characteristics are not critical. X8L exhibits a predictable change in capacitance with respect to time and voltage and boasts a minimal change in capacitance with reference to ambient temperature up to 125°C. Beyond 125°C X8L displays a wider variation in capacitance. Capacitance change is limited to $\pm 15\%$ from -55°C to +125°C and +15, -40% from 125°C to 150°C.

Driven by the demand for a more robust and reliable component, X8L dielectric capacitors were developed for critical applications where reliability at higher operating temperatures are a concern. These capacitors are widely used in automotive

circuits as well as general high temperature applications. Concerned with flex cracks resulting from excessive tensile and shear stresses produced during board flexure and thermal cycling? These devices are available with KEMET's Flexible termination technology which inhibits the transfer of board stress to the rigid ceramic body, therefore mitigating flex cracks which can result in low IR or short circuit failures. Although flexible termination technology does not eliminate the potential for mechanical damage that may propagate during extreme environmental and handling conditions, it does provide superior flex performance over standard termination systems.

In addition to commercial grade, automotive grade devices are available and meet the demanding Automotive Electronics Council's AEC-Q200 qualification requirements.

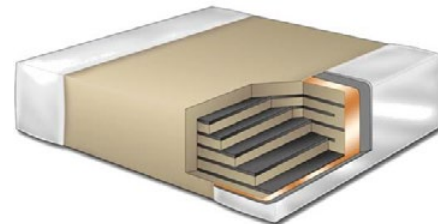

Ordering Information

C	1210	X	106	K	8	N	A	C	TU
Ceramic	Case Size (L" x W")	Specification/ Series ¹	Capacitance Code (pF)	Capacitance Tolerance	Voltage	Dielectric	Failure Rate/ Design	Termination Finish ²	Packaging/Grade (C-Spec) ³
	0402 0603 0805 1206 1210	C = Standard X = Flexible Termination	2 Significant Digits + Number of Zeros	J = $\pm 5\%$ K = $\pm 10\%$ M = $\pm 20\%$	8 = 10 V 3 = 25 V 5 = 50 V	N = X8L	A = N/A	C = 100% Matte Sn L = SnPb (5% minimum)	Blank = Bulk TU = 7" Reel Unmarked TM = 7" Reel Marked AUTO = Automotive Grade 7" Reel Unmarked

¹ The flexible termination option is not available on EIA 0402 case size product. "C" must be used in the 6th character position when ordering this case size.

² Additional termination finish options may be available. Contact KEMET for details.

³ SnPb termination finish option is not available on Automotive Grade product.

³ Additional reeling or packaging options may be available. Contact KEMET for details.

Dimensions – Standard Termination – Millimeters (Inches)

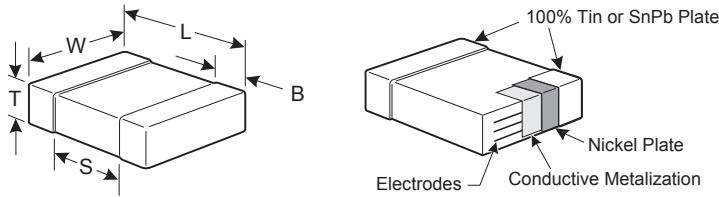

EIA Size Code	Metric Size Code	L Length	W Width	T Thickness	B Bandwidth	S Separation Minimum	Mounting Technique
0402	1005	1.00 (.040) ± 0.05 (.002)	0.50 (.020) ± 0.05 (.002)	See Table 2 for Thickness	0.30 (.012) ± 0.10 (.004)	0.30 (.012)	Solder Reflow Only
0603	1608	1.60 (.063) ± 0.15 (.006)	0.80 (.032) ± 0.15 (.006)		0.35 (.014) ± 0.15 (.006)	0.70 (.028)	Solder Wave or Solder Reflow
0805	2012	2.00 (.079) ± 0.20 (.008)	1.25 (.049) ± 0.20 (.008)		0.50 (0.02) ± 0.25 (.010)	0.75 (.030)	
1206	3216	3.20 (.126) ± 0.20 (.008)	1.60 (.063) ± 0.20 (.008)		0.50 (0.02) ± 0.25 (.010)	N/A	Solder Reflow Only
1210	3225	3.20 (.126) ± 0.20 (.008)	2.50 (.098) ± 0.20 (.008)		0.50 (0.02) ± 0.25 (.010)		

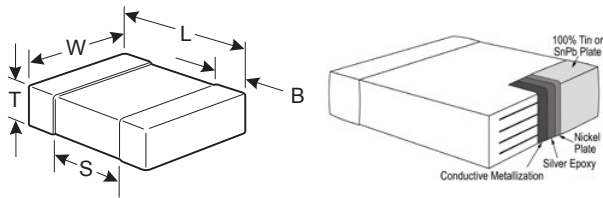

Dimensions – Flexible Termination – Millimeters (Inches)

EIA Size Code	Metric Size Code	L Length	W Width	T Thickness	B Bandwidth	S Separation Minimum	Mounting Technique
0603	1608	1.60 (.064) ± 0.17 (.007)	0.80 (.032) ± 0.15 (.006)	See Table 2 for Thickness	0.45 (.018) ± 0.15 (.006)	0.58 (.023)	Solder Wave or Solder Reflow
0805	2012	2.00 (.079) ± 0.20 (.008)	1.25 (.049) ± 0.20 (.008)		0.50 (0.02) ± 0.25 (.010)	0.75 (.030)	
1206	3216	3.30 (.130) ± 0.40 (.016)	1.60 (.063) ± 0.20 (.008)		0.60 (.024) ± 0.25 (.010)	N/A	Solder Reflow Only
1210	3225	3.30 (.130) ± 0.40 (.016)	2.50 (.098) ± 0.20 (.008)		0.60 (.024) ± 0.25 (.010)		

Benefits

- -55°C to +150°C operating temperature range
- Pb-Free and RoHS Compliant
- EIA 0402, 0603, 0805, 1206, and 1210 case sizes
- DC voltage ratings of 10 V, 25 V, and 50 V
- Capacitance offerings ranging from 0.012 µF to 10 µF
- Available capacitance tolerances of ±5%, ±10%, and ±20%
- Commercial & Automotive (AEC-Q200) grades available
- Non-polar device, minimizing installation concerns
- 100% pure matte tin-plated termination finish allowing for excellent solderability
- SnPb termination finish option available upon request (5% minimum)
- Flexible termination option available upon request

Applications

Typical applications include use in extreme environments such as down-hole oil exploration, under-hood automotive, military and aerospace.

Qualification/Certification

Commercial Grade products are subject to internal qualification. Details regarding test methods and conditions are referenced in Table 4, Performance & Reliability.

Automotive Grade products meet or exceed the requirements outlined by the Automotive Electronics Council. Details regarding test methods and conditions are referenced in document AEC-Q200, Stress Test Qualification for Passive Components. For additional information regarding the Automotive Electronics Council and AEC-Q200, please visit their website at www.aecouncil.com.

Environmental Compliance

Pb-Free and RoHS compliant (excluding SnPb termination finish option).



RoHS Compliant

Electrical Parameters/Characteristics

Item	Parameters/Characteristics
Operating Temperature Range	-55°C to +150°C
Capacitance Change with Reference to +25°C and 0 VDC Applied (TCC)	±15% (-55°C – 125°C) +15, -40% (125°C – 150°C)
Aging Rate (Maximum % Capacitance Loss/Decade Hour)	3.0%
Dielectric Withstanding Voltage (DWV)	250% of rated voltage (5 ±1 seconds and charge/discharge not exceeding 50 mA)
Dissipation Factor (DF) Maximum Limit @ 25°C	3.5% (10 V) and 2.5% (25 V and 50 V)
Insulation Resistance (IR) Limit @ 25°C	500 megohm microfarads or 10 GΩ (Rated voltage applied for 120 ±5 seconds @ 25°C)

Regarding aging rate: Capacitance measurements (including tolerance) are indexed to a referee time of 1,000 hours.

To obtain IR limit, divide $M\Omega\text{-}\mu F$ value by the capacitance and compare to $G\Omega$ limit. Select the lower of the two limits.

Capacitance and dissipation factor (DF) measured under the following conditions:

1 kHz ±50 Hz and 1.0 ±0.2 Vrms.

Note: When measuring capacitance it is important to ensure the set voltage level is held constant. The HP4284 and Agilent E4980 have a feature known as Automatic Level Control (ALC). The ALC feature should be switched to "ON."

Post Environmental Limits

High Temperature Life, Biased Humidity, Moisture Resistance					
Dielectric	Rated DC Voltage	Capacitance Value	Dissipation Factor (Maximum %)	Capacitance Shift	Insulation Resistance
X8L	> 25	All	3.0	±20%	10% of Initial Limit
	25		5.0		
	10		7.5		

Insulation Resistance Limit Table (X8L Dielectric)

EIA Case Size	1,000 Megohm Microfarads or 100 GΩ	500 Megohm Microfarads or 10 GΩ
0201	N/A	ALL
0402	< .012 μF	≥ .012 μF
0603	< .047 μF	≥ .047 μF
0805	< .047 μF	≥ .047 μF
1206	< 0.22 μF	≥ 0.22 μF
1210	< 0.39 μF	≥ 0.39 μF
1808	ALL	N/A
1812	< 2.2 μF	≥ 2.2 μF
1825	ALL	N/A
2220	< 10 μF	≥ 10 μF
2225	ALL	N/A

Table 1 – Capacitance Range/Selection Waterfall (0402 – 1210 Case Sizes)

Capacitance	Cap Code	Case Size / Series			C0402C		C0603C			C0805C			C1206C			C1210C		
		Voltage Code			8	3	8	3	5	8	3	5	8	3	5	8	3	5
		Rated Voltage (VDC)			10	25	10	25	50	10	25	50	10	25	50	10	25	50
		Capacitance Tolerance			Product Availability and Chip Thickness Codes See Table 2 for Chip Thickness Dimensions													
12,000 pF	123	J	K	M	BB	BB												
15,000 pF	153	J	K	M	BB	BB												
18,000 pF	183	J	K	M	BB	BB												
22,000 pF	223	J	K	M	BB	BB												
27,000 pF	273	J	K	M	BB	BB												
33,000 pF	333	J	K	M	BB													
39,000 pF	393	J	K	M	BB													
47,000 pF	473	J	K	M	BB		CB	CB	CB									
0.12 µF	124	J	K	M			CB	CB		DG	DG	DG						
0.15 µF	154	J	K	M			CB	CB		CB	CB							
0.18 µF	184	J	K	M			CB			DG	DG	DG						
0.22 µF	224	J	K	M			CB			DD	DD	DG						
0.27 µF	274	J	K	M						DD	DD							
0.33 µF	334	J	K	M						DD	DD							
0.39 µF	394	J	K	M						DE	DE					FD	FD	FD
0.47 µF	474	J	K	M						DE	DE		EG	EG	EG	FD	FD	FD
0.56 µF	564	J	K	M						DG	DH					FF	FF	FF
0.68 µF	684	J	K	M						DG	DH					FG	FG	FG
0.82 µF	824	J	K	M						DG						FL	FL	FL
1.0 µF	105	J	K	M						DG			ED	ED		FM	FM	FM
1.2 µF	125	J	K	M									EH	EH		FG	FG	
1.5 µF	155	J	K	M									EH	EH		FG	FG	
1.8 µF	185	J	K	M									EF	EH		FG	FG	
2.2 µF	225	J	K	M									EF	EH		FG	FG	
2.7 µF	275	J	K	M									EH			FG	FH	
3.3 µF	335	J	K	M									EH			FM	FM	
3.9 µF	395	J	K	M									EH			FG	FK	
4.7 µF	475	J	K	M									EH			FG	FS	
5.6 µF	565	J	K	M												FH		
6.8 µF	685	J	K	M												FM		
8.2 µF	825	J	K	M												FK		
10 µF	106	J	K	M												FS		
Capacitance	Cap Code	Rated Voltage (VDC)			10	25	10	25	50	10	25	50	10	25	50	10	25	50
		Voltage Code			8	3	8	3	5	8	3	5	8	3	5	8	3	5
		Case Size / Series			C0402C			C0603C			C0805C			C1206C			C1210C	

Table 2 – Chip Thickness/Packaging Quantities

Thickness Code	Case Size	Thickness ± Range (mm)	Paper Quantity		Plastic Quantity	
			7" Reel	13" Reel	7" Reel	13" Reel
BB	0402	0.50 ± 0.05	10,000	50,000	0	0
CB	0603	0.80 ± 0.07	4,000	10,000	0	0
DD	0805	0.90 ± 0.10	4,000	10,000	0	0
DE	0805	1.00 ± 0.10	0	0	2,500	10,000
DG	0805	1.25 ± 0.15	0	0	2,500	10,000
DH	0805	1.25 ± 0.20	0	0	2,500	10,000
ED	1206	1.00 ± 0.10	0	0	2,500	10,000
EF	1206	1.20 ± 0.15	0	0	2,500	10,000
EG	1206	1.60 ± 0.15	0	0	2,000	8,000
EH	1206	1.60 ± 0.20	0	0	2,000	8,000
FD	1210	0.95 ± 0.10	0	0	4,000	10,000
FF	1210	1.10 ± 0.10	0	0	2,500	10,000
FG	1210	1.25 ± 0.15	0	0	2,500	10,000
FL	1210	1.40 ± 0.15	0	0	2,000	8,000
FH	1210	1.55 ± 0.15	0	0	2,000	8,000
FM	1210	1.70 ± 0.20	0	0	2,000	8,000
FK	1210	2.10 ± 0.20	0	0	2,000	8,000
FS	1210	2.50 ± 0.30	0	0	1,000	4,000
Thickness Code	Case Size	Thickness ± Range (mm)	7" Reel	13" Reel	7" Reel	13" Reel
			Paper Quantity		Plastic Quantity	

Package quantity based on finished chip thickness specifications.

Table 3A – Land Pattern Design Recommendations per IPC-7351 – Standard Termination

EIA Size Code	Metric Size Code	Density Level A: Maximum (Most) Land Protrusion (mm)					Density Level B: Median (Nominal) Land Protrusion (mm)					Density Level C: Minimum (Least) Land Protrusion (mm)				
		C	Y	X	V1	V2	C	Y	X	V1	V2	C	Y	X	V1	V2
0402	1005	0.50	0.72	0.72	2.20	1.20	0.45	0.62	0.62	1.90	1.00	0.40	0.52	0.52	1.60	0.80
0603	1608	0.90	1.15	1.10	4.00	2.10	0.80	0.95	1.00	3.10	1.50	0.60	0.75	0.90	2.40	1.20
0805	2012	1.00	1.35	1.55	4.40	2.60	0.90	1.15	1.45	3.50	2.00	0.75	0.95	1.35	2.80	1.70
1206	3216	1.60	1.35	1.90	5.60	2.90	1.50	1.15	1.80	4.70	2.30	1.40	0.95	1.70	4.00	2.00
1210	3225	1.60	1.35	2.80	5.65	3.80	1.50	1.15	2.70	4.70	3.20	1.40	0.95	2.60	4.00	2.90
1210 ¹	3225	1.50	1.60	2.90	5.60	3.90	1.40	1.40	2.80	4.70	3.30	1.30	1.20	2.70	4.00	3.00

¹ Only for capacitance values ≥ 22 µF

Density Level A: For low-density product applications. Recommended for wave solder applications and provides a wider process window for reflow solder processes. KEMET only recommends wave soldering of EIA 0603, 0805 and 1206 case sizes.

Density Level B: For products with a moderate level of component density. Provides a robust solder attachment condition for reflow solder processes.

Density Level C: For high component density product applications. Before adapting the minimum land pattern variations the user should perform qualification testing based on the conditions outlined in IPC Standard 7351 (IPC-7351).

Table 3B – Land Pattern Design Recommendations per IPC–7351 – Flexible Termination

EIA Size Code	Metric Size Code	Density Level A: Maximum (Most) Land Protrusion (mm)					Density Level B: Median (Nominal) Land Protrusion (mm)					Density Level C: Minimum (Least) Land Protrusion (mm)				
		C	Y	X	V1	V2	C	Y	X	V1	V2	C	Y	X	V1	V2
0603	1608	0.85	1.25	1.10	4.00	2.10	0.75	1.05	1.00	3.10	1.50	0.65	0.85	0.90	2.40	1.20
0805	2012	1.00	1.35	1.55	4.40	2.60	0.90	1.15	1.45	3.50	2.00	0.80	0.95	1.35	2.80	1.70
1206	3216	1.60	1.65	1.90	5.90	2.90	1.50	1.45	1.80	5.00	2.30	1.40	1.25	1.70	4.30	2.00
1210	3225	1.60	1.65	2.80	5.90	3.80	1.50	1.45	2.70	5.00	3.20	1.40	1.25	2.60	4.30	2.90

Density Level A: For low-density product applications. Recommended for wave solder applications and provides a wider process window for reflow solder processes. KEMET only recommends wave soldering of EIA 0603, 0805 and 1206 case sizes.

Density Level B: For products with a moderate level of component density. Provides a robust solder attachment condition for reflow solder processes.

Density Level C: For high component density product applications. Before adapting the minimum land pattern variations the user should perform qualification testing based on the conditions outlined in IPC Standard 7351 (IPC–7351).

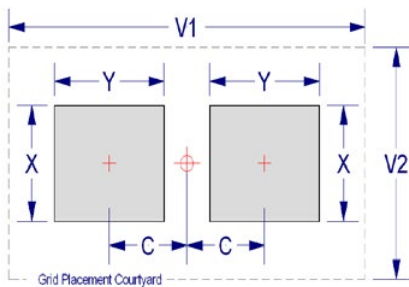

Soldering Process

Recommended Soldering Technique:

- Solder wave or solder reflow for EIA case sizes 0603, 0805 and 1206
- All other EIA case sizes are limited to solder reflow only

Recommended Soldering Profile:

- KEMET recommends following the guidelines outlined in IPC/JEDEC J–STD–020

Table 4 – Performance & Reliability: Test Methods and Conditions

Stress	Reference	Test or Inspection Method
Terminal Strength	JIS-C-6429	Appendix 1, Note: Force of 1.8 kg for 60 seconds.
Board Flex	JIS-C-6429	Appendix 2, Note: Standard termination system – 2.0 mm (minimum) for all except 3 mm for COG. Flexible termination system – 3.0 mm (minimum).
Solderability	J-STD-002	Magnification 50 X. Conditions:
		a) Method B, 4 hours @ 155°C, dry heat @ 235°C
		b) Method B @ 215°C category 3
		c) Method D, category 3 @ 260°C
Temperature Cycling	JESD22 Method JA-104	1,000 cycles (-55°C to +150°C). Measurement at 24 hours +/- 2 hours after test conclusion.
Biased Humidity	MIL-STD-202 Method 103	Load Humidity: 1,000 hours 85°C/85%RH and rated voltage. Add 100K ohm resistor. Measurement at 24 hours +/- 2 hours after test conclusion.
		Low Volt Humidity: 1,000 hours 85°C/85% RH and 1.5 V. Add 100 K ohm resistor. Measurement at 24 hours +/- 2 hours after test conclusion.
Moisture Resistance	MIL-STD-202 Method 106	t = 24 hours/cycle. Steps 7a and 7b not required. Unpowered. Measurement at 24 hours. +/- 2 hours after test conclusion.
Thermal Shock	MIL-STD-202 Method 107	-55°C/+150. Note: Number of cycles required – 300. Maximum transfer time – 20 seconds. Dwell time – 15 minutes. Air – Air.
High Temperature Life	MIL-STD-202 Method 108 /EIA-198	1,000 hours at 150°C with 2 X rated voltage applied.
Storage Life	MIL-STD-202 Method 108	150°C, 0 VDC for 1,000 hours.
Vibration	MIL-STD-202 Method 204	5 g's for 20 min., 12 cycles each of 3 orientations. Note: Use 8" X 5" PCB 0.031" thick 7 secure points on one long side and 2 secure points at corners of opposite sides. Parts mounted within 2" from any secure point. Test from 10 – 2,000 Hz
Mechanical Shock	MIL-STD-202 Method 213	Figure 1 of Method 213, Condition F.
Resistance to Solvents	MIL-STD-202 Method 215	Add aqueous wash chemical, OKEM Clean or equivalent.

Storage and Handling

Ceramic chip capacitors should be stored in normal working environments. While the chips themselves are quite robust in other environments, solderability will be degraded by exposure to high temperatures, high humidity, corrosive atmospheres, and long term storage. In addition, packaging materials will be degraded by high temperature– reels may soften or warp and tape peel force may increase. KEMET recommends that maximum storage temperature not exceed 40°C and maximum storage humidity not exceed 70% relative humidity. Temperature fluctuations should be minimized to avoid condensation on the parts and atmospheres should be free of chlorine and sulfur bearing compounds. For optimized solderability chip stock should be used promptly, preferably within 1.5 years of receipt.

Construction – Standard Termination

Reference	Item		Material	
A	Termination System	Finish	100% Matte Sn	SnPb (5% min)
B		Barrier Layer	Ni	
D		Base Metal	Cu	
E	Inner Electrode		Ni	
F	Dielectric Material		BaTiO ₃	

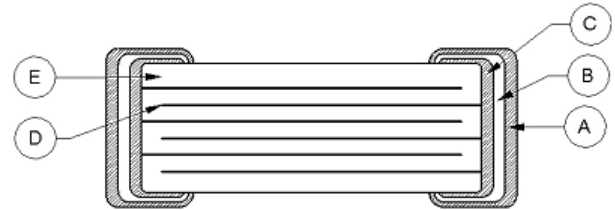

Note: Image is exaggerated in order to clearly identify all components of construction.

Construction – Flexible Termination

Reference	Item		Material	
A	Termination System	Finish	100% Matte Sn	SnPb (5% min)
B		Barrier Layer	Ni	
C		Epoxy Layer	Ag	
D	Base Metal		Cu	
E	Inner Electrode		Ni	
F	Dielectric Material		BaTiO ₃	

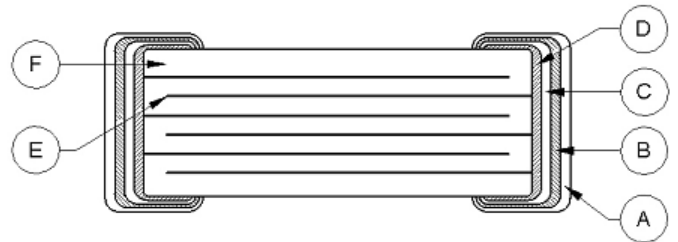

Note: Image is exaggerated in order to clearly identify all components of construction.

Telecom “Tip and Ring” X7R Dielectric, 250 VDC (Commercial Grade)

Overview

KEMET’s 250 V DC Tip and Ring MLCCs in X7R dielectric are designed and rated for telecommunication ringer circuits where the capacitor is used to block -48 V to -52 V DC of line voltage and pass a 16 – 25 Hz AC signal pulse of 70 VRMs to 90 VRMs. Serving as an excellent replacement for high voltage leaded film devices, these smaller surface mount technology footprints save valuable board space which is critical when creating new designs.

KEMET Tip and Ring capacitors feature a 125°C maximum operating temperature and are considered “temperature stable.” The Electronics Components, Assemblies & Materials Association (EIA) characterizes X7R dielectric as a Class II

material. Components of this classification are fixed, ceramic dielectric capacitors suited for bypass and decoupling applications or for frequency discriminating circuits where Q and stability of capacitance characteristics are not critical. X7R dielectric exhibits a predictable change in capacitance with respect to time and voltage and boasts a minimal change in capacitance with reference to ambient temperature. Capacitance change is limited to $\pm 15\%$ from -55°C to +125°C.

These devices are able to withstand today’s higher lead-free reflow processing temperatures and offer superior high frequency filtering characteristics and low ESR.

Benefits

- -55°C to +125°C operating temperature range
- Pb-Free and RoHS Compliant
- EIA 0805, 1206, 1210, 1812, 1825, 2220, and 2225 case sizes
- DC voltage rating of 250 V
- Capacitance offerings ranging from 1,000 pF to 6.8 μ F
- Available capacitance tolerances of $\pm 10\%$ and $\pm 20\%$
- Non-polar device, minimizing installation concerns
- 100% pure matte tin-plated termination finish that allows for excellent solderability
- SnPb termination finish option available upon request (5% minimum)
- Flexible termination option available upon request

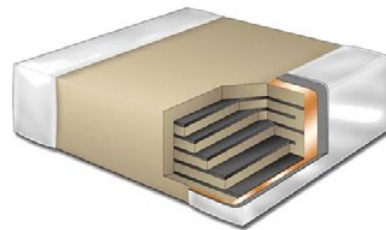

Ordering Information

C	1825	C	105	K	A	R	A	C	TU
Ceramic	Case Size (L" x W")	Specification/ Series	Capacitance Code (pF)	Capacitance Tolerance	Voltage	Dielectric	Failure Rate/ Design	Termination Finish ¹	Packaging/Grade (C-Spec) ²
	0805 1206 1210 1812 1825 2220 2225	C = Standard X = Flexible Termination	2 Significant Digits + Number of Zeros	J = $\pm 5\%$ K = $\pm 10\%$ M = $\pm 20\%$	A = 250 V	R = X7R	A = N/A	C = 100% Matte Sn L = SnPb (5% minimum)	Blank = Bulk TU = 7" Reel Unmarked TM = 7" Reel Marked

¹ Additional termination finish options may be available. Contact KEMET for details.

² Additional reeling or packaging options may be available. Contact KEMET for details.

Dimensions – Millimeters (Inches) – Standard Termination

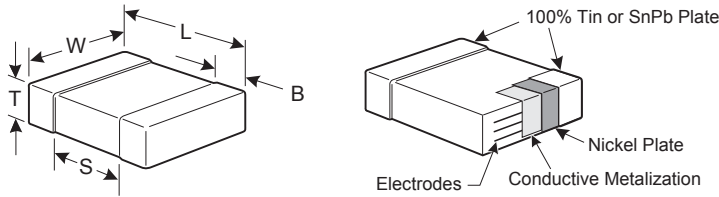

EIA Size Code	Metric Size Code	L Length	W Width	T Thickness	B Bandwidth	S Separation Minimum	Mounting Technique
0805	2012	2.00 (.079) ± 0.20 (.008)	1.25 (.049) ± 0.20 (.008)	See Table 2 for Thickness	0.50 (0.02) ± 0.25 (.010)	0.75 (.030)	Solder Wave or Solder Reflow
1206	3216	3.20 (.126) ± 0.20 (.008)	1.60 (.063) ± 0.20 (.008)		0.50 (0.02) ± 0.25 (.010)	N/A	
1210	3225	3.20 (.126) ± 0.20 (.008)	2.50 (.098) ± 0.20 (.008)		0.50 (0.02) ± 0.25 (.010)		
1812	4532	4.50 (.177) ± 0.30 (.012)	3.20 (.126) ± 0.30 (.012)		0.60 (.024) ± 0.35 (.014)		
1825	4564	4.50 (.177) ± 0.30 (.012)	6.40 (.252) ± 0.40 (.016)		0.60 (.024) ± 0.35 (.014)		
2220	5650	5.70 (.224) ± 0.40 (.016)	5.00 (.197) ± 0.40 (.016)		0.60 (.024) ± 0.35 (.014)		
2225	5664	5.60 (.220) ± 0.40 (.016)	6.40 (.248) ± 0.40 (.016)		0.60 (.024) ± 0.35 (.014)		

Dimensions – Millimeters (Inches) – Flexible Termination

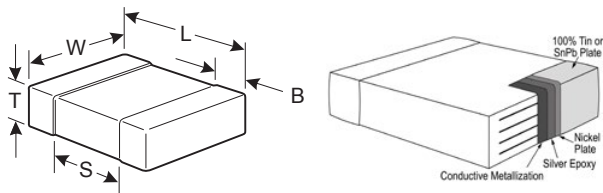

EIA Size Code	Metric Size Code	L Length	W Width	T Thickness	B Bandwidth	S Separation Minimum	Mounting Technique
0805	2012	2.00 (.079) ± 0.20 (.008)	1.25 (.049) ± 0.20 (.008)	See Table 2 for Thickness	0.50 (0.02) ± 0.25 (.010)	0.75 (.030)	Solder Wave or Solder Reflow
1206	3216	3.30 (.130) ± 0.40 (.016)	1.60 (.063) ± 0.20 (.008)		0.60 (.024) ± 0.25 (.010)	N/A	
1210	3225	3.30 (.130) ± 0.40 (.016)	2.50 (.098) ± 0.20 (.008)		0.60 (.024) ± 0.25 (.010)		
1812	4532	4.50 (.178) ± 0.40 (.016)	3.20 (.126) ± 0.30 (.012)		0.70 (.028) ± 0.35 (.014)		
1825	4564	4.60 (.181) ± 0.40 (.016)	6.40 (.252) ± 0.40 (.016)		0.70 (.028) ± 0.35 (.014)		
2220	5650	5.90 (.232) ± 0.75 (.030)	5.00 (.197) ± 0.40 (.016)		0.70 (.028) ± 0.35 (.014)		
2225	5664	5.90 (.232) ± 0.75 (.030)	6.40 (.248) ± 0.40 (.016)		0.70 (.028) ± 0.35 (.014)		

Applications

Typical applications include telecommunication ringing circuits, switch mode power supply snubber circuits, high voltage DC blocking and high voltage coupling. Markets include telephone lines, analog and digital modems, facsimile machines, wireless base stations, cable and digital video recording set-top boxes, satellite dishes, high voltage power supply, DC/DC converters, and Ethernet, POS and ATM hardware.

Qualification/Certification

Commercial Grade products are subject to internal qualification. Details regarding test methods and conditions are referenced in Table 4, Performance & Reliability.

Environmental Compliance

Pb-Free and RoHS Compliant (excluding SnPb termination finish option).



RoHS Compliant

Electrical Parameters/Characteristics

Item	Parameters/Characteristics
Operating Temperature Range	-55°C to +125°C
Capacitance Change with Reference to +25°C and 0 VDC Applied (TCC)	±15%
Aging Rate (Maximum % Capacitance Loss/Decade Hour)	3.0%
Dielectric Withstanding Voltage (DWV)	250% of rated voltage (5 ±1 seconds and charge/discharge not exceeding 50 mA)
Dissipation Factor (DF) Maximum Limit @ 25°C	5% (6.3 and 10 V), 3.5% (16 and 25 V) and 2.5% (50 to 250 V)
Insulation Resistance (IR) Limit @ 25°C	See Insulation Resistance Limit Table (Rated voltage applied for 120 ±5 seconds @ 25°C)

Regarding aging rate: Capacitance measurements (including tolerance) are indexed to a referee time of 1,000 hours.

To obtain IR limit, divide $M\Omega \cdot \mu F$ value by the capacitance and compare to $G\Omega$ limit. Select the lower of the two limits.

Capacitance and dissipation factor (DF) measured under the following conditions:

1 kHz ±50 Hz and 1.0 ±0.2 Vrms if capacitance ≤ 10 μF

120 Hz ±10 Hz and 0.5 ±0.1 Vrms if capacitance > 10 μF

Note: When measuring capacitance it is important to ensure the set voltage level is held constant. The HP4284 and Agilent E4980 have a feature known as Automatic Level Control (ALC). The ALC feature should be switched to "ON."

Table 1 – Capacitance Range/Selection Waterfall (0805 – 2225 Case Sizes)

Capacitance	Capacitance Code	Case Size / Series			C0805C	C1206C	C1210C	C1812C	C1825C	C2220C	C2225C
		Voltage Code			A	A	A	A	A	A	A
		Rated Voltage (VDC)			250	250	250	250	250	250	250
		Capacitance Tolerance			Product Availability and Chip Thickness Codes See Table 2 for Chip Thickness Dimensions						
180 pF	181	J	K	M	DC						
220 pF	221	J	K	M	DC						
270 pF	271	J	K	M	DC						
330 pF	331	J	K	M	DC						
390 pF	391	J	K	M	DC						
470 pF	471	J	K	M	DC						
560 pF	561	J	K	M	DC						
680 pF	681	J	K	M	DC						
820 pF	821	J	K	M	DC						
1000 pF	102	J	K	M	DC	EB					
1200 pF	122	J	K	M	DC	EB					
1500 pF	152	J	K	M	DC	EB					
1800 pF	182	J	K	M	DC	EB					
2200 pF	222	J	K	M	DC	EB	FB				
2700 pF	272	J	K	M	DC	EB	FB				
3300 pF	332	J	K	M	DC	EB	FB				
3900 pF	392	J	K	M	DC	EB	FB				
4700 pF	472	J	K	M	DC	EB	FB				
5600 pF	562	J	K	M	DC	EB	FB				
6800 pF	682	J	K	M	DC	EB	FB	GB			
8200 pF	822	J	K	M	DC	EB	FB	GB			
10000 pF	103	J	K	M	DC	EB	FB	GB			
12000 pF	123	J	K	M	DC	EB	FB	GB			
15000 pF	153	J	K	M	DC	EB	FB	GB			
18000 pF	183	J	K	M	DC	EB	FB	GB			
22000 pF	223	J	K	M	DC	EB	FB	GB	HB		
27000 pF	273	J	K	M		EB	FB	GB	HB		
33000 pF	333	J	K	M		EB	FB	GB	HB		
39000 pF	393	J	K	M		EB	FB	GB	HB		
47000 pF	473	J	K	M		ED	FC	GB	HB		
56000 pF	563	J	K	M		ED	FC	GB	HB		
68000 pF	683	J	K	M		ED	FC	GB	HB		
82000 pF	823	J	K	M		ED	FF	GB	HB	JC	
0.1 µF	104	J	K	M		EM	FG	GB	HB	JC	KC
0.12 µF	124	J	K	M				GB	HB	JC	KC
0.15 µF	154	J	K	M				GE	HB	JC	KC
0.18 µF	184	J	K	M				GG	HB	JC	KC
0.22 µF	224	J	K	M				GG	HB	JC	KC
0.27 µF	274	J	K	M				GG	HB	JC	KC
0.33 µF	334	J	K	M				GG	HB	JC	KC
0.39 µF	394	J	K	M				GG	HD	JC	KC
0.47 µF	474	J	K	M				GJ	HD	JC	KD
0.56 µF	564	J	K	M					HD	JD	KD
0.68 µF	684	J	K	M					HD	JD	KD
0.82 µF	824	J	K	M					HF	JF	KE
1 µF	105	J	K	M					HF	JF	KE
1.2 µF	125	J	K	M							KE
Capacitance	Capacitance Code	Rated Voltage (VDC)			250	250	250	250	250	250	250
		Voltage Code			A	A	A	A	A	A	A
		Case Size / Series			C0805C	C1206C	C1210C	C1812C	C1825C	C2220C	C2225C

**Capacitance range Includes E12 decade values only. (i.e., 10, 12, 15, 18, 22, 27, 33, 39, 47, 56, 68 and 82)

Table 2 – Chip Thickness/Packaging Quantities

Thickness Code	Case Size	Thickness ± Range (mm)	Paper Quantity		Plastic Quantity	
			7" Reel	13" Reel	7" Reel	13" Reel
DC	0805	0.78 ± 0.10	4,000	10,000	0	0
EB	1206	0.78 ± 0.10	4,000	10,000	4,000	10,000
ED	1206	1.00 ± 0.10	0	0	2,500	10,000
EM	1206	1.25 ± 0.15	0	0	2,500	10,000
FB	1210	0.78 ± 0.10	0	0	4,000	10,000
FC	1210	0.90 ± 0.10	0	0	4,000	10,000
FF	1210	1.10 ± 0.10	0	0	2,500	10,000
FG	1210	1.25 ± 0.15	0	0	2,500	10,000
GB	1812	1.00 ± 0.10	0	0	1,000	4,000
GE	1812	1.30 ± 0.10	0	0	1,000	4,000
GG	1812	1.55 ± 0.10	0	0	1,000	4,000
GJ	1812	1.70 ± 0.15	0	0	1,000	4,000
HB	1825	1.10 ± 0.15	0	0	1,000	4,000
HD	1825	1.30 ± 0.15	0	0	1,000	4,000
HF	1825	1.50 ± 0.15	0	0	1,000	4,000
JC	2220	1.10 ± 0.15	0	0	1,000	4,000
JD	2220	1.30 ± 0.15	0	0	1,000	4,000
JF	2220	1.50 ± 0.15	0	0	1,000	4,000
KC	2225	1.10 ± 0.15	0	0	1,000	4,000
KD	2225	1.30 ± 0.15	0	0	1,000	4,000
KE	2225	1.40 ± 0.15	0	0	1,000	4,000
Thickness Code	Case Size	Thickness ± Range (mm)	7" Reel	13" Reel	7" Reel	13" Reel
			Paper Quantity		Plastic Quantity	

Package quantity based on finished chip thickness specifications.

Table 3A – Land Pattern Design Recommendations per IPC-7351 – Standard Termination

EIA Size Code	Metric Size Code	Density Level A: Maximum (Most) Land Protrusion (mm)					Density Level B: Median (Nominal) Land Protrusion (mm)					Density Level C: Minimum (Least) Land Protrusion (mm)				
		C	Y	X	V1	V2	C	Y	X	V1	V2	C	Y	X	V1	V2
0805	2012	1.00	1.35	1.55	4.40	2.60	0.90	1.15	1.45	3.50	2.00	0.75	0.95	1.35	2.80	1.70
1206	3216	1.60	1.35	1.90	5.60	2.90	1.50	1.15	1.80	4.70	2.30	1.40	0.95	1.70	4.00	2.00
1210	3225	1.60	1.35	2.80	5.65	3.80	1.50	1.15	2.70	4.70	3.20	1.40	0.95	2.60	4.00	2.90
1210 ¹	3225	1.50	1.60	2.90	5.60	3.90	1.40	1.40	2.80	4.70	3.30	1.30	1.20	2.70	4.00	3.00
1812	4532	2.15	1.60	3.60	6.90	4.60	2.05	1.40	3.50	6.00	4.00	1.95	1.20	3.40	5.30	3.70
1825	4564	2.15	1.60	6.90	6.90	7.90	2.05	1.40	6.80	6.00	7.30	1.95	1.20	6.70	5.30	7.00
2220	5650	2.75	1.70	5.50	8.20	6.50	2.65	1.50	5.40	7.30	5.90	2.55	1.30	5.30	6.60	5.60
2225	5664	2.70	1.70	6.90	8.10	7.90	2.60	1.50	6.80	7.20	7.30	2.50	1.30	6.70	6.50	7.00

¹ Only for capacitance values ≥ 22 μF

Table 3B – Land Pattern Design Recommendations per IPC–7351 – Flexible Termination

EIA Size Code	Metric Size Code	Density Level A: Maximum (Most) Land Protrusion (mm)					Density Level B: Median (Nominal) Land Protrusion (mm)					Density Level C: Minimum (Least) Land Protrusion (mm)				
		C	Y	X	V1	V2	C	Y	X	V1	V2	C	Y	X	V1	V2
0805	2012	1.00	1.35	1.55	4.40	2.60	0.90	1.15	1.45	3.50	2.00	0.80	0.95	1.35	2.80	1.70
1206	3216	1.60	1.65	1.90	5.90	2.90	1.50	1.45	1.80	5.00	2.30	1.40	1.25	1.70	4.30	2.00
1210	3225	1.60	1.65	2.80	5.90	3.80	1.50	1.45	2.70	5.00	3.20	1.40	1.25	2.60	4.30	2.90
1812	4532	2.10	1.80	3.60	7.00	4.60	2.00	1.60	3.50	6.10	4.00	1.90	1.40	3.40	5.40	3.70
1825	4564	2.15	1.80	6.90	7.10	7.90	2.05	1.60	6.80	6.20	7.30	1.95	1.40	6.70	5.50	7.00
2220	5650	2.85	2.10	5.50	8.80	6.50	2.75	1.90	5.40	7.90	5.90	2.65	1.70	5.30	7.20	5.60
2225	5664	2.85	2.10	6.90	8.80	7.90	2.75	1.90	6.80	7.90	7.30	2.65	1.70	6.70	7.20	7.00

Density Level A: For low-density product applications. Recommended for wave solder applications and provides a wider process window for reflow solder processes. KEMET only recommends wave soldering of EIA 0603, 0805 and 1206 case sizes.

Density Level B: For products with a moderate level of component density. Provides a robust solder attachment condition for reflow solder processes.

Density Level C: For high component density product applications. Before adapting the minimum land pattern variations the user should perform qualification testing based on the conditions outlined in IPC Standard 7351 (IPC–7351).

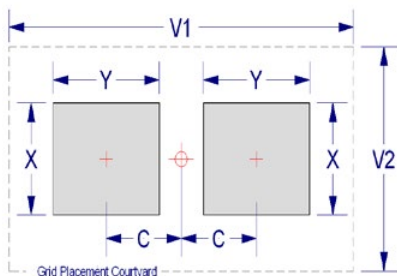

Soldering Process

Recommended Soldering Technique:

- Solder wave or solder reflow for EIA case sizes 0603, 0805 and 1206
- All other EIA case sizes are limited to solder reflow only

Recommended Soldering Profile:

- KEMET recommends following the guidelines outlined in IPC/JEDEC J–STD–020

Table 4 – Performance & Reliability: Test Methods and Conditions

Stress	Reference	Test or Inspection Method
Terminal Strength	JIS-C-6429	Appendix 1, Note: Force of 1.8 kg for 60 seconds.
Board Flex	JIS-C-6429	Appendix 2, Note: Standard termination system – 2.0 mm (minimum) for all except 3 mm for COG. Flexible termination system – 3.0 mm (minimum).
Solderability	J-STD-002	Magnification 50 X. Conditions:
		a) Method B, 4 hours @ 155°C, dry heat @ 235°C
		b) Method B @ 215°C category 3
		c) Method D, category 3 @ 260°C
Temperature Cycling	JESD22 Method JA-104	1,000 Cycles (-55°C to +125°C). Measurement at 24 hours +/- 2 hours after test conclusion.
Biased Humidity	MIL-STD-202 Method 103	Load Humidity: 1,000 hours 85°C/85% RH and rated voltage. Add 100 K ohm resistor. Measurement at 24 hours +/- 2 hours after test conclusion.
		Low Volt Humidity: 1,000 hours 85°C/85% RH and 1.5 V. Add 100 K ohm resistor. Measurement at 24 hours +/- 2 hours after test conclusion.
Moisture Resistance	MIL-STD-202 Method 106	t = 24 hours/cycle. Steps 7a and 7b not required. Unpowered. Measurement at 24 hours +/- 2 hours after test conclusion.
Thermal Shock	MIL-STD-202 Method 107	-55°C/+125°C. Note: Number of cycles required – 300, maximum transfer time – 20 seconds, dwell time – 15 minutes. Air – Air.
High Temperature Life	MIL-STD-202 Method 108 /EIA-198	1,000 hours at 125°C (85°C for X5R, Z5U and Y5V) with 2 X rated voltage applied.
Storage Life	MIL-STD-202 Method 108	150°C, 0 VDC for 1,000 hours.
Vibration	MIL-STD-202 Method 204	5 g's for 20 min., 12 cycles each of 3 orientations. Note: Use 8" X 5" PCB 0.031" thick 7 secure points on one long side and 2 secure points at corners of opposite sides. Parts mounted within 2" from any secure point. Test from 10 – 2,000 Hz
Mechanical Shock	MIL-STD-202 Method 213	Figure 1 of Method 213, Condition F.
Resistance to Solvents	MIL-STD-202 Method 215	Add aqueous wash chemical, OKEM Clean or equivalent.

Storage and Handling

Ceramic chip capacitors should be stored in normal working environments. While the chips themselves are quite robust in other environments, solderability will be degraded by exposure to high temperatures, high humidity, corrosive atmospheres, and long term storage. In addition, packaging materials will be degraded by high temperature– reels may soften or warp and tape peel force may increase. KEMET recommends that maximum storage temperature not exceed 40°C and maximum storage humidity not exceed 70% relative humidity. Temperature fluctuations should be minimized to avoid condensation on the parts and atmospheres should be free of chlorine and sulfur bearing compounds. For optimized solderability chip stock should be used promptly, preferably within 1.5 years of receipt.

Construction – Standard Termination

Reference	Item		Material	
A	Termination System	Finish	100% Matte Sn	SnPb (5% min)
B		Barrier Layer	Ni	
C		Base Metal	Cu	
D	Inner Electrode		Ni	
E	Dielectric Material		BaTiO ₃	

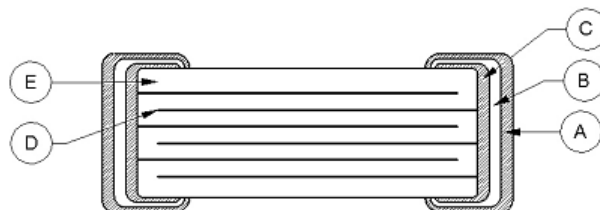

Note: Image is exaggerated in order to clearly identify all components of construction.

Construction – Flexible Termination

Reference	Item		Material	
A	Termination System	Finish	100% Matte Sn	SnPb (5% min)
B		Barrier Layer	Ni	
C		Epoxy Layer	Ag	
D	Base Metal		Cu	
E	Inner Electrode		Ni	
F	Dielectric Material		BaTiO ₃	

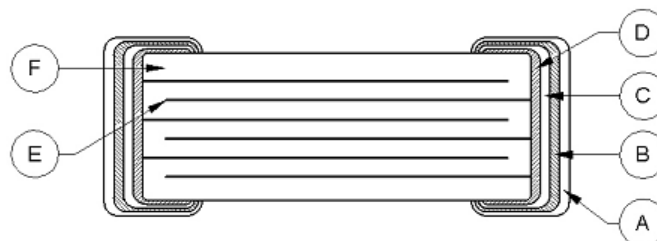

Note: Image is exaggerated in order to clearly identify all components of construction.

Open Mode Design (FO-CAP), X7R Dielectric, 16 – 200 VDC (Commercial & Automotive Grade)

Overview

KEMET's Ceramic Open Mode capacitor in X7R dielectric is designed to significantly minimize the probability of a low IR or short circuit condition when forced to failure in a board stress flex situation, thus reducing the potential for catastrophic failure. The Open Mode capacitor may experience a drop in capacitance; however, a short is unlikely because a crack will not typically propagate across counter electrodes within the device's "active area." Since there will not be any current leakage associated with a typical Open Mode flex crack, there is no localized heating and therefore little chance for a catastrophic and potentially costly failure event.

Driven by the demand for a more robust and reliable component, the Open Mode capacitor was designed for critical applications where higher operating temperatures and mechanical stress are a concern. These capacitors are widely used in automotive circuits as well as power supplies (input and output filters) and general electronic applications.

Concerned with flex cracks resulting from excessive tensile and shear stresses produced during board flexure and thermal cycling? These devices are available with KEMET's Flexible termination technology which inhibits the transfer of board stress to the rigid ceramic body, therefore mitigating flex cracks which can result in low IR or short circuit failures. Although flexible termination technology does not eliminate the potential for mechanical damage that may propagate during extreme environmental and handling conditions, it does provide superior flex performance over standard termination systems. When combined with flexible termination technology these devices offer the ultimate level of protection against a low IR or short circuit condition. Open Mode devices compliment KEMET's Floating Electrode (FE-CAP) and Floating Electrode with Flexible Termination (FF-CAP) product lines by providing a fail-safe design optimized for mid to high range capacitance values. These devices exhibit a predictable change in capacitance with respect to time and voltage and boast a minimal change in capacitance with reference to ambient temperature. Capacitance change is limited to $\pm 15\%$ from -55°C to $+125^{\circ}\text{C}$.

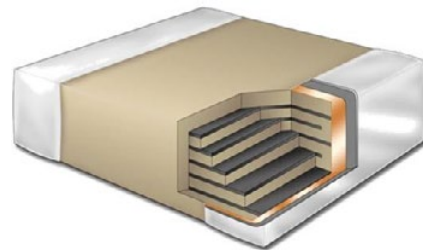

Ordering Information

C	1210	J	685	K	3	R	A	C	TU
Ceramic	Case Size (L" x W")	Specification/ Series	Capacitance Code (pF)	Capacitance Tolerance	Voltage	Dielectric	Failure Rate/ Design	Termination Finish ¹	Packaging/Grade (C-Spec) ²
	0805 1206 1210 1812	F = Open Mode J = Open Mode with Flexible Termination	2 Significant Digits + Number of Zeros	K = $\pm 10\%$ M = $\pm 20\%$	4 = 16 V 3 = 25 V 5 = 50 V 1 = 100 V 2 = 200 V	R = X7R	A = N/A	C = 100% Matte Sn L = SnPb (5% minimum)	Blank = Bulk TU = 7" Reel Unmarked TM = 7" Reel Marked AUTO = Automotive Grade

¹ Additional termination finish options may be available. Contact KEMET for details.

^{1,2} SnPb termination finish option is not available on automotive grade product.

² Additional reeling or packaging options may be available. Contact KEMET for details.

Dimensions – Millimeters (Inches) – Standard Termination

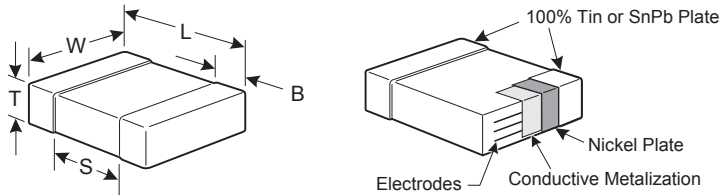

EIA Size Code	Metric Size Code	L Length	W Width	T Thickness	B Bandwidth	S Separation Minimum	Mounting Technique
0805	2012	2.00 (.079) ± 0.20 (.008)	1.25 (.049) ± 0.20 (.008)	See Table 2 for Thickness	0.50 (0.02) ± 0.25 (.010)	0.75 (.030)	Solder Wave or Solder Reflow
1206	3216	3.20 (.126) ± 0.20 (.008)	1.60 (.063) ± 0.20 (.008)		0.50 (0.02) ± 0.25 (.010)	N/A	
1210	3225	3.20 (.126) ± 0.20 (.008)	2.50 (.098) ± 0.20 (.008)		0.50 (0.02) ± 0.25 (.010)		Solder Reflow Only
1812	4532	4.50 (.177) ± 0.30 (.012)	3.20 (.126) ± 0.30 (.012)		0.60 (.024) ± 0.35 (.014)		

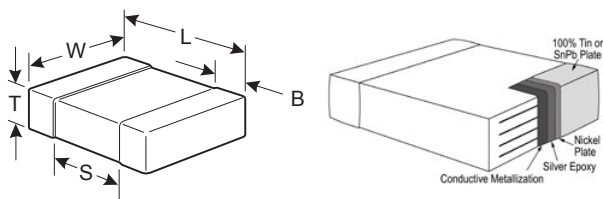

Dimensions – Millimeters (Inches) – Flexible Termination

EIA Size Code	Metric Size Code	L Length	W Width	T Thickness	B Bandwidth	S Separation Minimum	Mounting Technique
0805	2012	2.00 (.079) ± 0.20 (.008)	1.25 (.049) ± 0.20 (.008)	See Table 2 for Thickness	0.50 (0.02) ± 0.25 (.010)	0.75 (.030)	Solder Wave or Solder Reflow
1206	3216	3.30 (.130) ± 0.40 (.016)	1.60 (.063) ± 0.20 (.008)		0.60 (.024) ± 0.25 (.010)	N/A	
1210	3225	3.30 (.130) ± 0.40 (.016)	2.50 (.098) ± 0.20 (.008)		0.60 (.024) ± 0.25 (.010)		Solder Reflow Only
1812	4532	4.50 (.178) ± 0.40 (.016)	3.20 (.126) ± 0.30 (.012)		0.70 (.028) ± 0.35 (.014)		

Benefits

- -55°C to +125°C operating temperature range
- Open Mode/fail open design
- Mid to high capacitance flex mitigation
- Pb-Free and RoHS Compliant
- EIA 0805, 1206, 1210, and 1812 case sizes
- DC voltage ratings of 16 V, 25 V, 50 V, 100 V, and 200 V
- Capacitance offerings ranging from 1,000 pF to 6.8 µF
- Available capacitance tolerances of ±5%, ±10%, and ±20%
- Non-polar device, minimizing installation concerns
- 100% pure matte tin-plated termination finish allowing for excellent solderability
- Commercial and Automotive (AEC-Q200) grades available
- SnPb termination finish option available upon request (5% minimum)
- Flexible termination option available upon request

Applications

Typical applications include input side filtering (power plane/bus), high current (battery line) and circuits that cannot be fused to open when short circuits occur due to flex cracks. Markets include automotive applications that are directly connected to the battery and/or involve conversion to a 42 V system and raw power input side filtering in power conversion.

Qualification/Certification

Commercial Grade products are subject to internal qualification. Details regarding test methods and conditions are referenced in Table 4, Performance and Reliability.

Automotive Grade products meet or exceed the requirements outlined by the Automotive Electronics Council. Details regarding test methods and conditions are referenced in document AEC-Q200, Stress Test Qualification for Passive Components. For additional information regarding the Automotive Electronics Council and AEC-Q200, please visit their website at www.aecouncil.com.

Environmental Compliance

Pb-Free and RoHS Compliant (excluding SnPb termination finish option).



RoHS Compliant

Electrical Parameters/Characteristics

Item	Parameters/Characteristics
Operating Temperature Range	-55°C to +125°C
Capacitance Change with Reference to +25°C and 0 VDC Applied (TCC)	±15%
Aging Rate (Maximum % Capacitance Loss/Decade Hour)	3.0%
Dielectric Withstanding Voltage (DWV)	250% of rated voltage (5 ±1 seconds and charge/discharge not exceeding 50 mA)
Dissipation Factor (DF) Maximum Limit @ 25°C	5% (6.3 and 10 V), 3.5% (16 and 25 V) and 2.5% (50 to 250 V)
Insulation Resistance (IR) Limit @ 25°C	See Insulation Resistance Limit Table (Rated voltage applied for 120 ±5 seconds @ 25°C)

Regarding aging rate: Capacitance measurements (including tolerance) are indexed to a referee time of 1,000 hours.

To obtain IR limit, divide $M\Omega \cdot \mu F$ value by the capacitance and compare to $G\Omega$ limit. Select the lower of the two limits.

Capacitance and dissipation factor (DF) measured under the following conditions:

1 kHz ±50 Hz and 1.0 ±0.2 Vrms if capacitance ≤ 10 μF

120 Hz ±10Hz and 0.5 ±0.1 Vrms if capacitance > 10 μF

Note: When measuring capacitance it is important to ensure the set voltage level is held constant. The HP4284 and Agilent E4980 have a feature known as Automatic Level Control (ALC). The ALC feature should be switched to "ON."

Post Environmental Limits

High Temperature Life, Biased Humidity, Moisture Resistance					
Dielectric	Rated DC Voltage	Capacitance Value	Dissipation Factor (Maximum %)	Capacitance Shift	Insulation Resistance
X7R	> 25	All	3.0	±20%	10% of Initial Limit
	16/25		5.0		
	< 16		7.5		

Insulation Resistance Limit Table (X7R Dielectric)

EIA Case Size	1,000 Megohm Microfarads or 100 GΩ	500 Megohm Microfarads or 10 GΩ
0201	N/A	ALL
0402	< 0.012 μF	≥ 0.012 μF
0603	< 0.047 μF	≥ 0.047 μF
0805	< 0.047 μF	≥ 0.047 μF
1206	< 0.22 μF	≥ 0.22 μF
1210	< 0.39 μF	≥ 0.39 μF
1808	ALL	N/A
1812	< 2.2 μF	≥ 2.2 μF
1825	ALL	N/A
2220	< 10 μF	≥ 10 μF
2225	ALL	N/A

Table 2 – Chip Thickness/Packaging Quantities

Thickness Code	Case Size	Thickness ± Range (mm)	Paper Quantity		Plastic Quantity	
			7" Reel	13" Reel	7" Reel	13" Reel
DD	0805	0.90 ± 0.10	4,000	10,000	0	0
DE	0805	1.00 ± 0.10	0	0	2,500	10,000
DG	0805	1.25 ± 0.15	0	0	2,500	10,000
EC	1206	0.90 ± 0.10	0	0	4,000	10,000
ED	1206	1.00 ± 0.10	0	0	2,500	10,000
EG	1206	1.60 ± 0.15	0	0	2,000	8,000
EH	1206	1.60 ± 0.20	0	0	2,000	8,000
FD	1210	0.95 ± 0.10	0	0	4,000	10,000
FG	1210	1.25 ± 0.15	0	0	2,500	10,000
FH	1210	1.55 ± 0.15	0	0	2,000	8,000
FM	1210	1.70 ± 0.20	0	0	2,000	8,000
FJ	1210	1.85 ± 0.20	0	0	2,000	8,000
FR	1210	2.25 ± 0.20	0	0	2,000	8,000
FS	1210	2.50 ± 0.30	0	0	1,000	4,000
GB	1812	1.00 ± 0.10	0	0	1,000	4,000
GC	1812	1.10 ± 0.10	0	0	1,000	4,000
GD	1812	1.25 ± 0.15	0	0	1,000	4,000
GF	1812	1.50 ± 0.10	0	0	1,000	4,000
GK	1812	1.60 ± 0.20	0	0	1,000	4,000
GN	1812	1.70 ± 0.20	0	0	1,000	4,000
GL	1812	1.90 ± 0.20	0	0	500	2,000
GM	1812	2.00 ± 0.20	0	0	500	2,000
Thickness Code	Case Size	Thickness ± Range (mm)	7" Reel	13" Reel	7" Reel	13" Reel
			Paper Quantity		Plastic Quantity	

Package quantity based on finished chip thickness specifications.

Table 3A – Land Pattern Design Recommendations per IPC–7351 – Standard Termination

EIA Size Code	Metric Size Code	Density Level A: Maximum (Most) Land Protrusion (mm)					Density Level B: Median (Nominal) Land Protrusion (mm)					Density Level C: Minimum (Least) Land Protrusion (mm)				
		C	Y	X	V1	V2	C	Y	X	V1	V2	C	Y	X	V1	V2
0805	2012	1.00	1.35	1.55	4.40	2.60	0.90	1.15	1.45	3.50	2.00	0.75	0.95	1.35	2.80	1.70
1206	3216	1.60	1.35	1.90	5.60	2.90	1.50	1.15	1.80	4.70	2.30	1.40	0.95	1.70	4.00	2.00
1210	3225	1.60	1.35	2.80	5.65	3.80	1.50	1.15	2.70	4.70	3.20	1.40	0.95	2.60	4.00	2.90
1210 ¹	3225	1.50	1.60	2.90	5.60	3.90	1.40	1.40	2.80	4.70	3.30	1.30	1.20	2.70	4.00	3.00
1812	4532	2.15	1.60	3.60	6.90	4.60	2.05	1.40	3.50	6.00	4.00	1.95	1.20	3.40	5.30	3.70

¹ Only for capacitance values ≥ 22 μF

Density Level A: For low-density product applications. Recommended for wave solder applications and provides a wider process window for reflow solder processes. KEMET only recommends wave soldering of EIA 0603, 0805 and 1206 case sizes.

Density Level B: For products with a moderate level of component density. Provides a robust solder attachment condition for reflow solder processes.

Density Level C: For high component density product applications. Before adapting the minimum land pattern variations the user should perform qualification testing based on the conditions outlined in IPC Standard 7351 (IPC–7351).

Table 3B – Land Pattern Design Recommendations per IPC–7351 – Flexible Termination

EIA Size Code	Metric Size Code	Density Level A: Maximum (Most) Land Protrusion (mm)					Density Level B: Median (Nominal) Land Protrusion (mm)					Density Level C: Minimum (Least) Land Protrusion (mm)				
		C	Y	X	V1	V2	C	Y	X	V1	V2	C	Y	X	V1	V2
0805	2012	1.00	1.35	1.55	4.40	2.60	0.90	1.15	1.45	3.50	2.00	0.80	0.95	1.35	2.80	1.70
1206	3216	1.60	1.65	1.90	5.90	2.90	1.50	1.45	1.80	5.00	2.30	1.40	1.25	1.70	4.30	2.00
1210	3225	1.60	1.65	2.80	5.90	3.80	1.50	1.45	2.70	5.00	3.20	1.40	1.25	2.60	4.30	2.90
1812	4532	2.10	1.80	3.60	7.00	4.60	2.00	1.60	3.50	6.10	4.00	1.90	1.40	3.40	5.40	3.70

Density Level A: For low-density product applications. Recommended for wave solder applications and provides a wider process window for reflow solder processes. KEMET only recommends wave soldering of EIA 0603, 0805 and 1206 case sizes.

Density Level B: For products with a moderate level of component density. Provides a robust solder attachment condition for reflow solder processes.

Density Level C: For high component density product applications. Before adapting the minimum land pattern variations the user should perform qualification testing based on the conditions outlined in IPC Standard 7351 (IPC–7351).

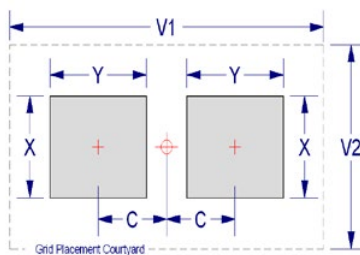

Soldering Process

Recommended Soldering Technique:

- Solder wave or solder reflow for EIA case sizes 0603, 0805 and 1206
- All other EIA case sizes are limited to solder reflow only

Recommended Soldering Profile:

- KEMET recommends following the guidelines outlined in IPC/JEDEC J–STD–020

Table 4 – Performance & Reliability: Test Methods and Conditions

Stress	Reference	Test or Inspection Method
Terminal Strength	JIS-C-6429	Appendix 1, Note: Force of 1.8 kg for 60 seconds.
Board Flex	JIS-C-6429	Appendix 2, Note: Standard termination system – 2.0 mm (minimum) for all except 3 mm for COG. Flexible termination system – 3.0 mm (minimum).
Solderability	J-STD-002	Magnification 50 X. Conditions:
		a) Method B, 4 hours @ 155°C, dry heat @ 235°C
		b) Method B @ 215°C category 3
		c) Method D, category 3 @ 260°C
Temperature Cycling	JESD22 Method JA-104	1,000 Cycles (-55°C to +125°C). Measurement at 24 hours +/- 2 hours after test conclusion.
Biased Humidity	MIL-STD-202 Method 103	Load Humidity: 1,000 hours 85°C/85% RH and rated voltage. Add 100 K ohm resistor. Measurement at 24 hours +/- 2 hours after test conclusion.
		Low Volt Humidity: 1,000 hours 85°C/85% RH and 1.5 V. Add 100 K ohm resistor. Measurement at 24 hours +/- 2 hours after test conclusion.
Moisture Resistance	MIL-STD-202 Method 106	t = 24 hours/cycle. Steps 7a and 7b not required. Unpowered. Measurement at 24 hours +/- 2 hours after test conclusion.
Thermal Shock	MIL-STD-202 Method 107	-55°C/+125°C. Note: Number of cycles required – 300, maximum transfer time – 20 seconds, dwell time – 15 minutes. Air – Air.
High Temperature Life	MIL-STD-202 Method 108 /EIA-198	1,000 hours at 125°C (85°C for X5R, Z5U and Y5V) with 2 X rated voltage applied.
Storage Life	MIL-STD-202 Method 108	150°C, 0 VDC for 1,000 hours.
Vibration	MIL-STD-202 Method 204	5 g's for 20 min., 12 cycles each of 3 orientations. Note: Use 8" X 5" PCB 0.031" thick 7 secure points on one long side and 2 secure points at corners of opposite sides. Parts mounted within 2" from any secure point. Test from 10 – 2,000 Hz
Mechanical Shock	MIL-STD-202 Method 213	Figure 1 of Method 213, Condition F.
Resistance to Solvents	MIL-STD-202 Method 215	Add aqueous wash chemical, OKEM Clean or equivalent.

Storage and Handling

Ceramic chip capacitors should be stored in normal working environments. While the chips themselves are quite robust in other environments, solderability will be degraded by exposure to high temperatures, high humidity, corrosive atmospheres, and long term storage. In addition, packaging materials will be degraded by high temperature– reels may soften or warp and tape peel force may increase. KEMET recommends that maximum storage temperature not exceed 40°C and maximum storage humidity not exceed 70% relative humidity. Temperature fluctuations should be minimized to avoid condensation on the parts and atmospheres should be free of chlorine and sulfur bearing compounds. For optimized solderability chip stock should be used promptly, preferably within 1.5 years of receipt.

Construction – Standard Termination

Reference	Item		Material	
A	Termination System	Finish	100% Matte Sn	SnPb (5% min)
B		Barrier Layer	Ni	
C		Base Metal	Cu	
D	Inner Electrode		Ni	
E	Dielectric Material		BaTiO ₃	

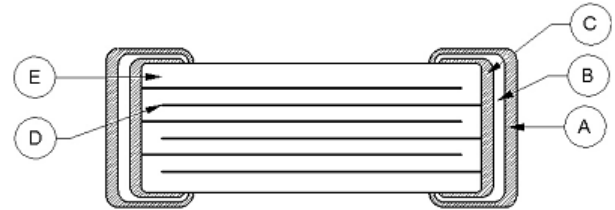

Note: Image is exaggerated in order to clearly identify all components of construction.

Construction – Flexible Termination

Reference	Item		Material	
A	Termination System	Finish	100% Matte Sn	SnPb (5% min)
B		Barrier Layer	Ni	
C		Epoxy Layer	Ag	
D		Base Metal	Cu	
E	Inner Electrode		Ni	
F	Dielectric Material		BaTiO ₃	

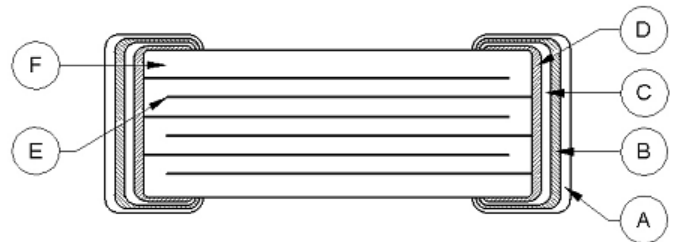

Note: Image is exaggerated in order to clearly identify all components of construction.

Floating Electrode Design (FE-CAP), X7R Dielectric, 6.3 – 250 VDC (Commercial & Automotive Grade)

Overview

KEMET's Floating Electrode (FE-CAP) multilayer ceramic capacitor in X7R dielectric utilizes a cascading internal electrode design configured to form multiple capacitors in series within a single monolithic structure. This unique configuration results in enhanced voltage and ESD performance over standard capacitor designs while allowing for a fail-open condition if mechanically damaged (cracked). If damaged, the device may experience a drop in capacitance but a short is unlikely. The FE-CAP is designed to reduce the likelihood of a low IR or short circuit condition and the chance for a catastrophic and potentially costly failure event.

Driven by the demand for a more robust and reliable component, the FE-CAP was designed for critical applications where higher operating temperatures and mechanical stress are a concern. These capacitors are manufactured in state of the

art ISO/TS 16949:2009 certified facilities and are widely used in power supplies (input and output filters) and general electronic applications.

Combined with the stability of an X7R dielectric, the FE-CAP complements KEMET's "Open Mode" devices by providing a fail-safe design optimized for low to mid range capacitance values. These devices exhibit a predictable change in capacitance with respect to time and voltage and boast a minimal change in capacitance with reference to ambient temperature. Capacitance change is limited to $\pm 15\%$ from -55°C to $+125^{\circ}\text{C}$.

In addition to Commercial Grade, Automotive Grade devices are available which meet the demanding Automotive Electronics Council's AEC-Q200 qualification requirements.

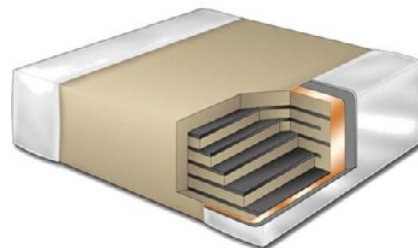

Ordering Information

C	0805	S	104	K	5	R	A	C	TU
Ceramic	Case Size (L" x W")	Specification/ Series	Capacitance Code (pF)	Capacitance Tolerance	Voltage	Dielectric	Failure Rate/ Design	Termination Finish ¹	Packaging/Grade (C-Spec) ²
	0402 0603 0805 1206 1210 1812	S = Floating Electrode	2 Significant Digits + Number of Zeros	J = $\pm 5\%$ K = $\pm 10\%$ M = $\pm 20\%$	9 = 6.3 V 8 = 10 V 4 = 16 V 3 = 25 V 5 = 50 V 1 = 100 V 2 = 200 V A = 250 V	R = X7R	A = N/A	C = 100% Matte Sn L = SnPb (5% minimum)	Blank = Bulk TU = 7" Reel Unmarked TM = 7" Reel Marked

¹ Additional termination finish options may be available. Contact KEMET for details.

^{1,2} SnPb termination finish option is not available on automotive grade product.

² Additional reeling or packaging options may be available. Contact KEMET for details.

Dimensions – Millimeters (Inches)

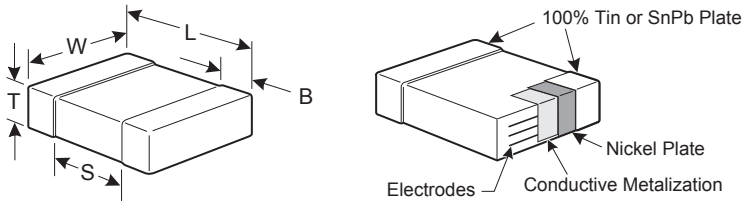

EIA Size Code	Metric Size Code	L Length	W Width	T Thickness	B Bandwidth	S Separation Minimum	Mounting Technique
0402	1005	1.00 (.040) ± 0.05 (.002)	0.50 (.020) ± 0.05 (.002)	See Table 2 for Thickness	0.30 (.012) ± 0.10 (.004)	0.30 (.012)	Solder Reflow Only
0603	1608	1.60 (.063) ± 0.15 (.006)	0.80 (.032) ± 0.15 (.006)		0.35 (.014) ± 0.15 (.006)	0.70 (.028)	Solder Wave or Solder Reflow
0805	2012	2.00 (.079) ± 0.20 (.008)	1.25 (.049) ± 0.20 (.008)		0.50 (0.02) ± 0.25 (.010)	0.75 (.030)	
1206	3216	3.20 (.126) ± 0.20 (.008)	1.60 (.063) ± 0.20 (.008)		0.50 (0.02) ± 0.25 (.010)	N/A	Solder Reflow Only
1210	3225	3.20 (.126) ± 0.20 (.008)	2.50 (.098) ± 0.20 (.008)		0.50 (0.02) ± 0.25 (.010)		
1812	4532	4.50 (.177) ± 0.30 (.012)	3.20 (.126) ± 0.30 (.012)		0.60 (.024) ± 0.35 (.014)		

Benefits

- -55°C to +125°C operating temperature range
- Floating Electrode/fail open design
- Low to mid capacitance flex mitigation
- Pb-Free and RoHS Compliant
- EIA 0402, 0603, 0805, 1206, 1210, and 1812 case sizes
- DC voltage ratings of 6.3 V, 10 V, 16 V, 25 V, 50 V, 100 V, 200 V, and 250 V
- Capacitance offerings ranging from 150 pF to 0.22 µF
- Available capacitance tolerances of ±5%, ±10%, and ±20%
- Commercial and Automotive (AEC-Q200) grades available
- Non-polar device, minimizing installation concerns
- 100% pure matte tin-plated termination finish allowing for excellent solderability
- SnPb termination finish option available upon request (5% minimum)

Applications

Typical applications include circuits with a direct battery or power source connection, critical and safety relevant circuits without (integrated) current limitation and any application that is subject to high levels of board flexure or temperature cycling. Examples include raw power input side filtering (power plane/bus), high current applications (automobile battery line) and circuits that cannot be fused to open. Markets include consumer, medical, industrial (power supply), automotive, aerospace and telecom.

Qualification/Certification

Commercial Grade products are subject to internal qualification. Details regarding test methods and conditions are referenced in Table 4 , Performance and Reliability.

Automotive Grade products meet or exceed the requirements outlined by the Automotive Electronics Council. Details regarding test methods and conditions are referenced in document AEC–Q200, Stress Test Qualification for Passive Components. For additional information regarding the Automotive Electronics Council and AEC–Q200, please visit their website at www.aecouncil.com.

Environmental Compliance

Pb-Free and RoHS Compliant (excluding SnPb termination finish option).



RoHS Compliant

Electrical Parameters/Characteristics

Item	Parameters/Characteristics
Operating Temperature Range	-55°C to +125°C
Capacitance Change with Reference to +25°C and 0 VDC Applied (TCC)	±15%
Aging Rate (Maximum % Capacitance Loss/Decade Hour)	3.0%
Dielectric Withstanding Voltage (DWV)	250% of rated voltage (5 ±1 seconds and charge/discharge not exceeding 50 mA)
Dissipation Factor (DF) Maximum Limit @ 25°C	5% (6.3 and 10 V), 3.5% (16 and 25 V) and 2.5% (50 to 250 V)
Insulation Resistance (IR) Limit @ 25°C	See Insulation Resistance Limit Table (Rated voltage applied for 120 ±5 seconds @ 25°C)

Regarding aging rate: Capacitance measurements (including tolerance) are indexed to a referee time of 1,000 hours.

To obtain IR limit, divide $M\Omega\text{-}\mu F$ value by the capacitance and compare to $G\Omega$ limit. Select the lower of the two limits.

Capacitance and dissipation factor (DF) measured under the following conditions:

1 kHz ±50 Hz and 1.0 ±0.2 Vrms if capacitance ≤ 10 μF

120 Hz ±10 Hz and 0.5 ±0.1 Vrms if capacitance > 10 μF

Note: When measuring capacitance it is important to ensure the set voltage level is held constant. The HP4284 and Agilent E4980 have a feature known as Automatic Level Control (ALC). The ALC feature should be switched to "ON."

Post Environmental Limits

High Temperature Life, Biased Humidity, Moisture Resistance					
Dielectric	Rated DC Voltage	Capacitance Value	Dissipation Factor (Maximum %)	Capacitance Shift	Insulation Resistance
X7R	> 25	All	3.0	±20%	10% of Initial Limit
	16/25		5.0		
	< 16		7.5		

Insulation Resistance Limit Table (X7R Dielectric)

EIA Case Size	1,000 Megohm Microfarads or 100 GΩ	500 Megohm Microfarads or 10 GΩ
0201	N/A	ALL
0402	< 0.012 μF	≥ 0.012 μF
0603	< 0.047 μF	≥ 0.047 μF
0805	< 0.047 μF	≥ 0.047 μF
1206	< 0.22 μF	≥ 0.22 μF
1210	< 0.39 μF	≥ 0.39 μF
1808	ALL	N/A
1812	< 2.2 μF	≥ 2.2 μF
1825	ALL	N/A
2220	< 10 μF	≥ 10 μF
2225	ALL	N/A

Table 1A – Capacitance Range/Selection Waterfall (0402 – 0805 Case Sizes)

Capacitance	Cap Code	Case Size / Series	C0402S					C0603S						C0805S											
		Voltage Code	9	8	4	3	5	9	8	4	3	5	1	2	9	8	4	3	5	1	2	A			
		Rated Voltage (VDC)	6.3	10	16	25	50	6.3	10	16	25	50	100	200	6.3	10	16	25	50	100	200	250			
		Capacitance Tolerance	Product Availability and Chip Thickness Codes See Table 2 for Chip Thickness Dimensions																						
150 pF	151	J	K	M	BB	BB	BB	BB	BB	CB	CB	CB	CB	CB	CB	CB	DC	DC	DC	DC	DC	DC	DC	DC	DC
180 pF	181	J	K	M	BB	BB	BB	BB	BB	CB	CB	CB	CB	CB	CB	CB	DC	DC	DC	DC	DC	DC	DC	DC	DC
220 pF	221	J	K	M	BB	BB	BB	BB	BB	CB	CB	CB	CB	CB	CB	CB	DC	DC	DC	DC	DC	DC	DC	DC	DC
270 pF	271	J	K	M	BB	BB	BB	BB	BB	CB	CB	CB	CB	CB	CB	CB	DC	DC	DC	DC	DC	DC	DC	DC	DC
330 pF	331	J	K	M	BB	BB	BB	BB	BB	CB	CB	CB	CB	CB	CB	CB	DC	DC	DC	DC	DC	DC	DC	DC	DC
390 pF	391	J	K	M	BB	BB	BB	BB	BB	CB	CB	CB	CB	CB	CB	CB	DC	DC	DC	DC	DC	DC	DC	DC	DC
470 pF	471	J	K	M	BB	BB	BB	BB	BB	CB	CB	CB	CB	CB	CB	CB	DC	DC	DC	DC	DC	DC	DC	DC	DC
560 pF	561	J	K	M	BB	BB	BB	BB	BB	CB	CB	CB	CB	CB	CB	CB	DC	DC	DC	DC	DC	DC	DC	DC	DC
680 pF	681	J	K	M	BB	BB	BB	BB	BB	CB	CB	CB	CB	CB	CB	CB	DC	DC	DC	DC	DC	DC	DC	DC	DC
820 pF	821	J	K	M	BB	BB	BB	BB	BB	CB	CB	CB	CB	CB	CB	CB	DC	DC	DC	DC	DC	DC	DC	DC	DC
1,000 pF	102	J	K	M	BB	BB	BB	BB	BB	CB	CB	CB	CB	CB	CB	CB	DC	DC	DC	DC	DC	DC	DC	DC	DC
1,200 pF	122	J	K	M						CB	CB	CB	CB	CB	CB	CB	DC	DC	DC	DC	DC	DC	DC	DC	DC
1,500 pF	152	J	K	M						CB	CB	CB	CB	CB	CB	CB	DC	DC	DC	DC	DC	DC	DC	DC	DC
1,800 pF	182	J	K	M						CB	CB	CB	CB	CB	CB	CB	DC	DC	DC	DC	DC	DC	DC	DC	DC
2,200 pF	222	J	K	M						CB	CB	CB	CB	CB	CB	CB	DC	DC	DC	DC	DC	DC	DC	DC	DC
2,700 pF	272	J	K	M						CB	CB	CB	CB	CB	CB	CB	DC	DC	DC	DC	DC	DC	DC	DC	DC
3,300 pF	332	J	K	M						CB	CB	CB	CB	CB	CB	CB	DC	DC	DC	DC	DC	DC	DC	DC	DC
3,900 pF	392	J	K	M						CB	CB	CB	CB	CB	CB	CB	DC	DC	DC	DC	DC	DC	DC	DC	DC
4,700 pF	472	J	K	M						CB	CB	CB	CB	CB	CB	CB	DC	DC	DC	DC	DC	DC	DC	DC	DC
5,600 pF	562	J	K	M						CB	CB	CB	CB	CB	CB	CB	DC	DC	DC	DC	DC	DC	DC	DC	DC
6,800 pF	682	J	K	M						CB	CB	CB	CB	CB	CB	CB	DC	DC	DC	DC	DC	DC	DC	DC	DC
8,200 pF	822	J	K	M						CB	CB	CB	CB	CB	CB	CB	DC	DC	DC	DC	DC	DC	DC	DC	DC
10,000 pF	103	J	K	M						CB	CB	CB	CB	CB	CB	CB	DC	DC	DC	DC	DC	DC	DC	DC	DC
12,000 pF	123	J	K	M						CB	CB	CB	CB	CB	CB	CB	DC	DC	DC	DC	DC	DC	DC	DC	DC
15,000 pF	153	J	K	M						CB	CB	CB	CB	CB	CB	CB	DC	DC	DC	DC	DC	DC	DD	DD	DD
18,000 pF	183	J	K	M						CB	CB	CB	CB	CB	CB	CB	DC	DC	DC	DC	DC	DC	DD	DD	DD
22,000 pF	223	J	K	M						CB	CB	CB	CB	CB	CB	CB	DC	DC	DC	DC	DC	DC	DD	DD	DD
27,000 pF	273	J	K	M													DC	DC	DC	DC	DC	DC			
33,000 pF	333	J	K	M													DC	DC	DC	DC	DC	DC			
39,000 pF	393	J	K	M													DC	DC	DC	DC	DC	DC			
47,000 pF	473	J	K	M													DC	DC	DC	DC	DC	DC			
56,000 pF	563	J	K	M													DD	DD	DD	DD	DD	DD			
68,000 pF	683	J	K	M													DD	DD	DD	DD	DD	DD			
82,000 pF	823	J	K	M													DG	DG	DG	DG	DG	DG			
0.10 µF	104	J	K	M													DG	DG	DG	DG	DG	DG			
Capacitance	Cap Code	Rated Voltage (VDC)	6.3	10	16	25	50	6.3	10	16	25	50	100	200	6.3	10	16	25	50	100	200	250			
		Voltage Code	9	8	4	3	5	9	8	4	3	5	1	2	9	8	4	3	5	1	2	A			
		Case Size / Series	C0402S					C0603S						C0805S											

Table 2 – Chip Thickness/Packaging Quantities

Thickness Code	Case Size	Thickness ± Range (mm)	Paper Quantity		Plastic Quantity	
			7" Reel	13" Reel	7" Reel	13" Reel
BB	0402	0.50 ± 0.05	10,000	50,000	0	0
CB	0603	0.80 ± 0.07	4,000	10,000	0	0
CF	0603	0.80 ± 0.07	4,000	15,000	0	0
DC	0805	0.78 ± 0.10	4,000	10,000	0	0
DD	0805	0.90 ± 0.10	4,000	10,000	0	0
DG	0805	1.25 ± 0.15	0	0	2,500	10,000
EB	1206	0.78 ± 0.10	4,000	10,000	4,000	10,000
EC	1206	0.90 ± 0.10	0	0	4,000	10,000
FB	1210	0.78 ± 0.10	0	0	4,000	10,000
FC	1210	0.90 ± 0.10	0	0	4,000	10,000
FD	1210	0.95 ± 0.10	0	0	4,000	10,000
GB	1812	1.00 ± 0.10	0	0	1,000	4,000
Thickness Code	Case Size	Thickness ± Range (mm)	7" Reel	13" Reel	7" Reel	13" Reel
			Paper Quantity		Plastic Quantity	

Package quantity based on finished chip thickness specifications.

Table 3 – Chip Capacitor Land Pattern Design Recommendations per IPC–7351

EIA Size Code	Metric Size Code	Density Level A: Maximum (Most) Land Protrusion (mm)					Density Level B: Median (Nominal) Land Protrusion (mm)					Density Level C: Minimum (Least) Land Protrusion (mm)				
		C	Y	X	V1	V2	C	Y	X	V1	V2	C	Y	X	V1	V2
0402	1005	0.50	0.72	0.72	2.20	1.20	0.45	0.62	0.62	1.90	1.00	0.40	0.52	0.52	1.60	0.80
0603	1608	0.90	1.15	1.10	4.00	2.10	0.80	0.95	1.00	3.10	1.50	0.60	0.75	0.90	2.40	1.20
0805	2012	1.00	1.35	1.55	4.40	2.60	0.90	1.15	1.45	3.50	2.00	0.75	0.95	1.35	2.80	1.70
1206	3216	1.60	1.35	1.90	5.60	2.90	1.50	1.15	1.80	4.70	2.30	1.40	0.95	1.70	4.00	2.00
1210	3225	1.60	1.35	2.80	5.65	3.80	1.50	1.15	2.70	4.70	3.20	1.40	0.95	2.60	4.00	2.90
1210 ¹	3225	1.50	1.60	2.90	5.60	3.90	1.40	1.40	2.80	4.70	3.30	1.30	1.20	2.70	4.00	3.00
1812	4532	2.15	1.60	3.60	6.90	4.60	2.05	1.40	3.50	6.00	4.00	1.95	1.20	3.40	5.30	3.70

¹ Only for capacitance values ≥ 22 μF

Density Level A: For low-density product applications. Recommended for wave solder applications and provides a wider process window for reflow solder processes. KEMET only recommends wave soldering of EIA 0603, 0805 and 1206 case sizes.

Density Level B: For products with a moderate level of component density. Provides a robust solder attachment condition for reflow solder processes.

Density Level C: For high component density product applications. Before adapting the minimum land pattern variations the user should perform qualification testing based on the conditions outlined in IPC Standard 7351 (IPC–7351).

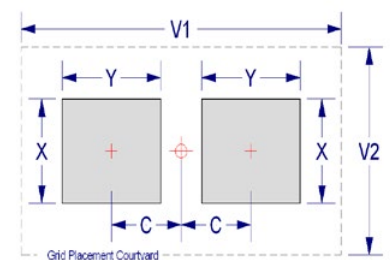

Soldering Process

Recommended Soldering Technique:

- Solder wave or solder reflow for EIA case sizes 0603, 0805 and 1206
- All other EIA case sizes are limited to solder reflow only

Recommended Soldering Profile:

- KEMET recommends following the guidelines outlined in IPC/JEDEC J–STD–020

Table 4 – Performance & Reliability: Test Methods and Conditions

Stress	Reference	Test or Inspection Method
Terminal Strength	JIS–C–6429	Appendix 1, Note: Force of 1.8 kg for 60 seconds.
Board Flex	JIS–C–6429	Appendix 2, Note: Standard termination system – 2.0 mm (minimum) for all except 3 mm for COG. Flexible termination system – 3.0 mm (minimum).
Solderability	J–STD–002	Magnification 50 X. Conditions:
		a) Method B, 4 hours @ 155°C, dry heat @ 235°C
		b) Method B @ 215°C category 3
		c) Method D, category 3 @ 260°C
Temperature Cycling	JESD22 Method JA–104	1,000 Cycles (-55°C to +125°C). Measurement at 24 hours +/- 2 hours after test conclusion.
Biased Humidity	MIL–STD–202 Method 103	Load Humidity: 1,000 hours 85°C/85% RH and rated voltage. Add 100 K ohm resistor. Measurement at 24 hours +/- 2 hours after test conclusion.
		Low Volt Humidity: 1,000 hours 85°C/85% RH and 1.5 V. Add 100 K ohm resistor. Measurement at 24 hours +/- 2 hours after test conclusion.
Moisture Resistance	MIL–STD–202 Method 106	t = 24 hours/cycle. Steps 7a and 7b not required. Unpowered. Measurement at 24 hours +/- 2 hours after test conclusion.
Thermal Shock	MIL–STD–202 Method 107	-55°C/+125°C. Note: Number of cycles required – 300, maximum transfer time – 20 seconds, dwell time – 15 minutes. Air – Air.
High Temperature Life	MIL–STD–202 Method 108 /EIA–198	1,000 hours at 125°C (85°C for X5R, Z5U and Y5V) with 2 X rated voltage applied.
Storage Life	MIL–STD–202 Method 108	150°C, 0 VDC for 1,000 hours.
Vibration	MIL–STD–202 Method 204	5 g's for 20 min., 12 cycles each of 3 orientations. Note: Use 8" X 5" PCB 0.031" thick 7 secure points on one long side and 2 secure points at corners of opposite sides. Parts mounted within 2" from any secure point. Test from 10 – 2,000 Hz
Mechanical Shock	MIL–STD–202 Method 213	Figure 1 of Method 213, Condition F.
Resistance to Solvents	MIL–STD–202 Method 215	Add aqueous wash chemical, OKEM Clean or equivalent.

Storage and Handling

Ceramic chip capacitors should be stored in normal working environments. While the chips themselves are quite robust in other environments, solderability will be degraded by exposure to high temperatures, high humidity, corrosive atmospheres, and long term storage. In addition, packaging materials will be degraded by high temperature– reels may soften or warp and tape peel force may increase. KEMET recommends that maximum storage temperature not exceed 40°C and maximum storage humidity not exceed 70% relative humidity. Temperature fluctuations should be minimized to avoid condensation on the parts and atmospheres should be free of chlorine and sulfur bearing compounds. For optimized solderability chip stock should be used promptly, preferably within 1.5 years of receipt.

Construction

Reference	Item		Material	
A	Termination System	Finish	100% Matte Sn	SnPb (5% min)
B		Barrier Layer	Ni	
C		Base Metal	Cu	
D	Inner Electrode		Ni	
E	Dielectric Material		BaTiO ₃	

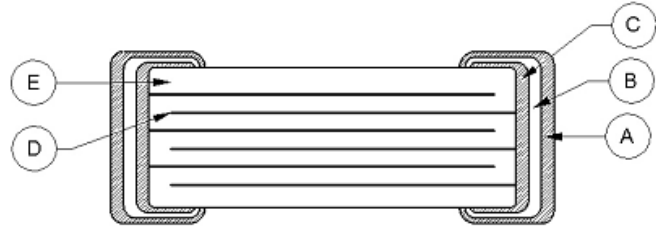

Note: Image is exaggerated in order to clearly identify all components of construction.

Flexible Termination System (FT-CAP) X7R Dielectric, 6.3 – 250 VDC (Commercial & Automotive Grade)

Overview

KEMET's Flexible Termination (FT-CAP) multilayer ceramic capacitor in X7R dielectric incorporates a unique, flexible termination system that is integrated with KEMET's standard termination materials. A conductive silver epoxy is utilized between the base metal and nickel barrier layers of KEMET's standard termination system in order to establish pliability while maintaining terminal strength, solderability and electrical performance. This technology was developed in order to address the primary failure mode of MLCCs— flex cracks, which are typically the result of excessive tensile and shear stresses produced during board flexure and thermal cycling. Flexible termination technology inhibits the transfer of board stress to the rigid ceramic body, therefore mitigating flex cracks which can result in low IR or short circuit failures.

Although this technology does not eliminate the potential for mechanical damage that may propagate during extreme

environmental and handling conditions, it does provide superior flex performance over standard termination systems. FT-CAP complements KEMET's Open Mode, Floating Electrode (FE-CAP), Floating Electrode with Flexible Termination (FF-CAP) and KEMET Power Solutions (KPS) product lines by providing a complete portfolio of flex mitigation solutions.

Combined with the stability of an X7R dielectric and designed to accommodate all capacitance requirements, these flex-robust devices are RoHS-compliant, offer up to 5mm of flex-bend capability and exhibit a predictable change in capacitance with respect to time and voltage. Capacitance change with reference to ambient temperature is limited to $\pm 15\%$ from -55°C to $+125^{\circ}\text{C}$.

In addition to commercial grade, automotive grade devices are available which meet the demanding Automotive Electronics Council's AEC-Q200 qualification requirements.

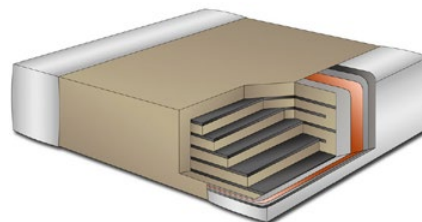

Ordering Information

C	1206	X	106	K	4	R	A	C	AUTO
Ceramic	Case Size (L" x W")	Specification/ Series	Capacitance Code (pF)	Capacitance Tolerance	Voltage	Dielectric	Failure Rate/ Design	Termination Finish ¹	Packaging/Grade (C-Spec) ²
	0603 0805 1206 1210 1808 1812 1825 2220 2225	X = Flexible Termination	2 significant digits + number of zeros	J = $\pm 5\%$ K = $\pm 10\%$ M = $\pm 20\%$	9 = 6.3 V 8 = 10 V 4 = 16 V 3 = 25 V 5 = 50 V 1 = 100 V 2 = 200 V A = 250 V	R = X7R	A = N/A	C = 100% Matte Sn L = SnPb (5% minimum)	Blank = Bulk TU = 7" Reel Unmarked TM = 7" Reel Marked AUTO = Automotive Grade 7" Reel Unmarked

¹ Additional termination finish options may be available. Contact KEMET for details.

^{1,2} SnPb termination finish option is not available on Automotive Grade product.

² Additional reeling or packaging options may be available. Contact KEMET for details.

Dimensions – Millimeters (Inches)

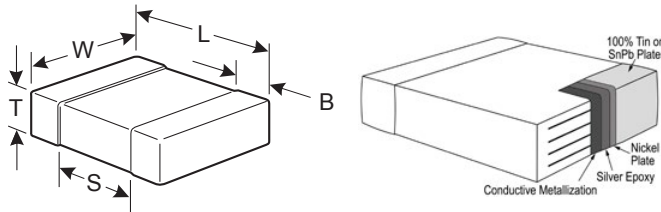

EIA Size Code	Metric Size Code	L Length	W Width	T Thickness	B Bandwidth	S Separation Minimum	Mounting Technique
0603	1608	1.60 (.064) ± 0.17 (.007)	0.80 (.032) ± 0.15 (.006)	See Table 2 for Thickness	0.45 (.018) ± 0.15 (.006)	0.58 (.023)	Solder Wave or Solder Reflow
0805	2012	2.00 (.079) ± 0.20 (.008)	1.25 (.049) ± 0.20 (.008)		0.50 (0.02) ± 0.25 (.010)	0.75 (.030)	
1206	3216	3.30 (.130) ± 0.40 (.016)	1.60 (.063) ± 0.20 (.008)		0.60 (.024) ± 0.25 (.010)	N/A	Solder Reflow Only
1210 ¹	3225	3.30 (.130) ± 0.40 (.016)	2.50 (.098) ± 0.20 (.008)		0.60 (.024) ± 0.25 (.010)		
1808	4520	4.70 (.185) ± 0.50 (.020)	2.00 (.079) ± 0.20 (.008)		0.70 (.028) ± 0.35 (.014)		
1812	4532	4.50 (.178) ± 0.40 (.016)	3.20 (.126) ± 0.30 (.012)		0.70 (.028) ± 0.35 (.014)		
1825	4564	4.60 (.181) ± 0.40 (.016)	6.40 (.252) ± 0.40 (.016)		0.70 (.028) ± 0.35 (.014)		
2220	5650	5.90 (.232) ± 0.75 (.030)	5.00 (.197) ± 0.40 (.016)		0.70 (.028) ± 0.35 (.014)		
2225	5664	5.90 (.232) ± 0.75 (.030)	6.40 (.248) ± 0.40 (.016)		0.70 (.028) ± 0.35 (.014)		

¹ For capacitance values ≥ 12 μF add 0.02 (0.001) to the width tolerance dimension

Benefits

- -55°C to +125°C operating temperature range
- Superior flex performance (up to 5 mm)
- High capacitance flex mitigation
- Pb-Free and RoHS Compliant
- EIA 0603, 0805, 1206, 1210, 1808, 1812, 1825, 2220, and 2225 case sizes
- DC voltage ratings of 6.3 V, 10 V, 16 V, 25 V, 50 V, 100 V, 200 V, and 250 V
- Capacitance offerings ranging from 180 pF to 22 μF
- Available capacitance tolerances of ±5%, ±10%, and ±20%
- Non-polar device, minimizing installation concerns
- 100% pure matte tin-plated termination finish allowing for excellent solderability
- SnPb termination finish option available upon request (5% min)
- Commercial and Automotive (AEC-Q200) grades available

Applications

Typical applications include circuits with a direct battery or power source connection, critical and safety relevant circuits without (integrated) current limitation and any application that is subject to high levels of board flexure or temperature cycling. Examples include raw power input side filtering (power plane/bus), high current applications (automobile battery line) and circuits that cannot be fused to open. Markets include consumer, medical, industrial (power supply), automotive, aerospace and telecom.

Qualification/Certification

Commercial Grade products are subject to internal qualification. Details regarding test methods and conditions are referenced in Table 4, Performance & Reliability.

Automotive Grade products meet or exceed the requirements outlined by the Automotive Electronics Council. Details regarding test methods and conditions are referenced in document AEC-Q200, Stress Test Qualification for Passive Components. For additional information regarding the Automotive Electronics Council and AEC-Q200, please visit their website at www.aecouncil.com.

Environmental Compliance

Pb-Free and RoHS Compliant (excluding SnPb termination finish option).



RoHS Compliant

Electrical Parameters/Characteristics

Item	Parameters/Characteristics
Operating Temperature Range	-55°C to +125°C
Capacitance Change with Reference to +25°C and 0 VDC Applied (TCC)	±15%
Aging Rate (Maximum % Capacitance Loss/Decade Hour)	3.0%
Dielectric Withstanding Voltage (DWV)	250% of rated voltage (5 ±1 seconds and charge/discharge not exceeding 50 mA)
Dissipation Factor (DF) Maximum Limit @ 25°C	5% (6.3 and 10 V), 3.5% (16 and 25 V) and 2.5% (50 to 250 V)
Insulation Resistance (IR) Limit @ 25°C	See Insulation Resistance Limit Table (Rated voltage applied for 120 ±5 seconds @ 25°C)

Regarding aging rate: Capacitance measurements (including tolerance) are indexed to a referee time of 1,000 hours.

To obtain IR limit, divide $M\Omega\text{-}\mu F$ value by the capacitance and compare to $G\Omega$ limit. Select the lower of the two limits.

Capacitance and dissipation factor (DF) measured under the following conditions:

1 kHz ±50 Hz and 1.0 ±0.2 Vrms if capacitance ≤ 10 μF

120 Hz ±10 Hz and 0.5 ±0.1 Vrms if capacitance > 10 μF

Note: When measuring capacitance it is important to ensure the set voltage level is held constant. The HP4284 and Agilent E4980 have a feature known as Automatic Level Control (ALC). The ALC feature should be switched to "ON."

Post Environmental Limits

High Temperature Life, Biased Humidity, Moisture Resistance					
Dielectric	Rated DC Voltage	Capacitance Value	Dissipation Factor (Maximum %)	Capacitance Shift	Insulation Resistance
X7R	> 25	All	3.0	±20%	10% of Initial Limit
	16/25		5.0		
	< 16		7.5		

Insulation Resistance Limit Table (X7R Dielectric)

EIA Case Size	1,000 Megohm Microfarads or 100 GΩ	500 Megohm Microfarads or 10 GΩ
0201	N/A	ALL
0402	< 0.012 μF	≥ 0.012 μF
0603	< 0.047 μF	≥ 0.047 μF
0805	< 0.047 μF	≥ 0.047 μF
1206	< 0.22 μF	≥ 0.22 μF
1210	< 0.39 μF	≥ 0.39 μF
1808	ALL	N/A
1812	< 2.2 μF	≥ 2.2 μF
1825	ALL	N/A
2220	< 10 μF	≥ 10 μF
2225	ALL	N/A

Table 1A – Capacitance Range/Selection Waterfall (0603 – 1210 Case Sizes)

Cap	Cap Code	Case Size / Series				C0603X								C0805X								C1206X								C1210X							
		Voltage Code				9	8	4	3	5	1	2	9	8	4	3	5	1	2	A	9	8	4	3	5	1	2	A	9	8	4	3	5	1	2	A	
		Rated Voltage (VDC)				6.3	10	16	25	50	100	200	6.3	10	16	25	50	100	200	250	6.3	10	16	25	50	100	200	250	6.3	10	16	25	50	100	200	250	
		Cap Tolerance				Product Availability and Chip Thickness Codes – See Table 2 for Chip Thickness Dimensions																															
180 pF	181	J	K	M	CB	CB	CB	CB	CB	CB	CB	DC	DC	DC	DC	DC	DC	DC	EB	EB	EB	EB	EB														
220 pF	221	J	K	M	CB	CB	CB	CB	CB	CB	CB	DC	DC	DC	DC	DC	DC	DC																			
270 pF	271	J	K	M	CB	CB	CB	CB	CB	CB	CB	DC	DC	DC	DC	DC	DC	DC																			
330 pF	331	J	K	M	CB	CB	CB	CB	CB	CB	CB	DC	DC	DC	DC	DC	DC	DC																			
390 pF	391	J	K	M	CB	CB	CB	CB	CB	CB	CB	DC	DC	DC	DC	DC	DC	DC																			
470 pF	471	J	K	M	CB	CB	CB	CB	CB	CB	CB	DC	DC	DC	DC	DC	DC	DC	EB	EB	EB	EB	EB														
560 pF	561	J	K	M	CB	CB	CB	CB	CB	CB	CB	DC	DC	DC	DC	DC	DC	DC																			
680 pF	681	J	K	M	CB	CB	CB	CB	CB	CB	CB	DC	DC	DC	DC	DC	DC	DC																			
820 pF	821	J	K	M	CB	CB	CB	CB	CB	CB	CB	DC	DC	DC	DC	DC	DC	DC																			
1,000 pF	102	J	K	M	CB	CB	CB	CB	CB	CB	CF	DC	DC	DC	DC	DC	DC	DC	EB	EB	EB	EB	EB	EB	EB	EB											
1,200 pF	122	J	K	M	CB	CB	CB	CB	CB	CB	CB	DC	DC	DC	DC	DC	DC	DC	EB	EB	EB	EB	EB	EB	EB	EB											
1,500 pF	152	J	K	M	CB	CB	CB	CB	CB	CB	CB	DC	DC	DC	DC	DC	DC	DC	EB	EB	EB	EB	EB	EB	EB	EB											
1,800 pF	182	J	K	M	CB	CB	CB	CB	CB	CB	CB	DC	DC	DC	DC	DC	DC	DC	EB	EB	EB	EB	EB	EB	EB	EB											
2,200 pF	222	J	K	M	CB	CB	CB	CB	CB	CB	CF	DC	DC	DC	DC	DC	DC	DC	EB	EB	EB	EB	EB	EB	EB	EB	EB	EB	EB	EB	EB						
2,700 pF	272	J	K	M	CB	CB	CB	CB	CB	CB	CF	DC	DC	DC	DC	DC	DC	DC	EB	EB	EB	EB	EB	EB	EB	EB	EB	EB	EB	EB	EB						
3,300 pF	332	J	K	M	CB	CB	CB	CB	CB	CB	CB	DC	DC	DC	DC	DC	DC	DC	EB	EB	EB	EB	EB	EB	EB	EB	EB	EB	EB	EB	EB						
3,900 pF	392	J	K	M	CB	CB	CB	CB	CB	CB	CB	DC	DC	DC	DC	DC	DC	DC	EB	EB	EB	EB	EB	EB	EB	EB	EB	EB	EB	EB	EB						
4,700 pF	472	J	K	M	CB	CB	CB	CB	CB	CB	CB	DC	DC	DC	DC	DC	DC	DC	EB	EB	EB	EB	EB	EB	EB	EB	EB	EB	EB	EB	EB						
5,600 pF	562	J	K	M	CB	CB	CB	CB	CB	CB	CB	DC	DC	DC	DC	DC	DC	DC	EB	EB	EB	EB	EB	EB	EB	EB	EB	EB	EB	EB	EB						
6,800 pF	682	J	K	M	CB	CB	CB	CB	CB	CB	CB	DC	DC	DC	DC	DC	DC	DC	EB	EB	EB	EB	EB	EB	EB	EB	EB	EB	EB	EB	EB						
8,200 pF	822	J	K	M	CB	CB	CB	CB	CB	CB	CB	DC	DC	DC	DC	DC	DC	DC	EB	EB	EB	EB	EB	EB	EB	EB	EB	EB	EB	EB	EB						
10,000 pF	103	J	K	M	CB	CB	CB	CB	CB	CF	CF	DC	DC	DC	DC	DC	DC	DC	EB	EB	EB	EB	EB	EB	EB	EB	EB	EB	EB	EB	EB						
12,000 pF	123	J	K	M	CB	CB	CB	CB	CB	CB		DC	DC	DC	DC	DC	DC	DC	EB	EB	EB	EB	EB	EB	EB	EB	EB	EB	EB	EB	EB						
15,000 pF	153	J	K	M	CB	CB	CB	CB	CB	CB		DC	DC	DC	DC	DC	DC	DC	EB	EB	EB	EB	EB	EB	EB	EB	EB	EB	EB	EB	EB						
18,000 pF	183	J	K	M	CB	CB	CB	CB	CB	CB		DC	DC	DC	DC	DC	DC	DC	EB	EB	EB	EB	EB	EB	EB	EB	EB	EB	EB	EB	EB						
22,000 pF	223	J	K	M	CB	CB	CB	CB	CF	CF		DC	DC	DC	DC	DC	DC	DC	EB	EB	EB	EB	EB	EB	EB	EB	EB	EB	EB	EB	EB						
27,000 pF	273	J	K	M	CB	CB	CB	CB	CB	CB		DC	DC	DC	DC	DC	DC	DC	EB	EB	EB	EB	EB	EB	EB	EB	EB	EB	EB	EB	EB						
33,000 pF	333	J	K	M	CB	CB	CB	CF	CB	CB		DC	DC	DC	DC	DC	DC	DC	EB	EB	EB	EB	EB	EB	EB	EB	EB	EB	EB	EB	EB						
39,000 pF	393	J	K	M	CB	CB	CB	CB	CB	CB		DC	DC	DC	DC	DC	DC	DC	EB	EB	EB	EB	EB	EB	EB	EB	EB	EB	EB	EB	EB						
47,000 pF	473	J	K	M	CB	CB	CB	CB	CF	CB		DC	DC	DC	DC	DC	DC	DC	EB	EB	EB	EB	EB	EB	EB	EB	EB	EB	EB	EB	EB						
56,000 pF	563	J	K	M	CB	CB	CB	CB	CB			DD	DD	DD	DD	DD	DD	DD	EB	EB	EB	EB	EB	EB	EB	EB	EB	EB	EB	EB	EB						
68,000 pF	683	J	K	M	CB	CB	CB	CB	CF			DD	DD	DD	DD	DD	DD	DD	EB	EB	EB	EB	EB	EB	EB	EB	EB	EB	EB	EB	EB						
82,000 pF	823	J	K	M	CB	CB	CB	CB	CB			DD	DD	DD	DD	DD	DD	DD	EB	EB	EB	EB	EB	EB	EB	EB	EB	EB	EB	EB	EB						
0.10 μF	104	J	K	M	CB	CB	CF	CF	CF			DC	DC	DC	DC	DC	DC	DC	EB	EB	EB	EB	EB	EB	EB	EM	EM	EB	EB	EB							
0.12 μF	124	J	K	M	CB	CB	CB	CB	CB			DC	DC	DC	DC	DC	DC	DC	EC	EC	EC	EC	EC	EC	EC	EG	EB	EB	EB	EB							
0.15 μF	154	J	K	M	CB	CB	CB	CB	CD			DC	DC	DC	DC	DC	DC	DC	EC	EC	EC	EC	EC	EC	EC	EG	FC	FC	FC	FC							
0.18 μF	184	J	K	M	CB	CB	CB	CB	CB			DC	DC	DC	DC	DC	DC	DC	EC	EC	EC	EC	EC	EC	EC	EG	FC	FC	FC	FC							
0.22 μF	224	J	K	M	CB	CB	CB	CD				DC	DC	DC	DC	DC	DC	DC	EC	EC	EC	EC	EC	EC	EG	FC	FC	FC	FC	FC							
0.27 μF	274	J	K	M	CB	CB	CB					DD	DD	DD	DD	DD	DD	DD	EB	EB	EB	EB	EB	EB	EM	FC	FC	FC	FC	FC							
0.33 μF	334	J	K	M	CB	CB	CB					DG	DG	DG	DG	DD	DD	DD	EB	EB	EB	EB	EB	EB	EG	FD	FD	FD	FD	FD							
0.39 μF	394	J	K	M	CB	CB	CB					DG	DG	DG	DG	DE	DE	DE	EB	EB	EB	EB	EB	EB	EG	FD	FD	FD	FD	FD							
0.47 μF	474	J	K	M	CB	CB	CB					DG	DG	DG	DG	DE	DE	DE	EC	EC	EC	EC	EC	EG	FD	FD	FD	FD	FD	FD							
0.56 μF	564	J	K	M								DD	DD	DD	DG	DH	DH	DH	ED	ED	ED	ED	ED	ED	EG	FD	FD	FD	FD	FD							
0.68 μF	684	J	K	M								DD	DD	DD	DG	DH	DH	DH	EE	EE	EE	EE	EE	ED	EG	FD	FD	FD	FD	FD							
0.82 μF	824	J	K	M								DD	DD	DD	DG	DH	DH	DH	EE	EE	EE	EE	ED	EG	FF	FD	FD	FD	FD	FD							
1.0 μF	105	J	K	M								DD	DD	DD	DG				EF	EF	EF	EG	ED			FH	FH	FH	FH	FM							
1.2 μF	125	J	K	M								DE	DE	DE					ED	ED	ED	EG	EH			FH	FH	FH	FH	FG							
1.5 μF	155	J	K	M								DG	DG	DG					EF	EF	EF	EG	EH			FH	FH	FH	FH	FG							
1.8 μF	185	J	K	M								DG	DG	DG					ED	ED	ED	EF	EH			FH	FH	FH	FH	FG							
2.2 μF	225	J	K	M								DG	DG	DG					ED	ED	ED	EF	EH			FJ	FJ	FJ	FJ	FG							
2.7 μF	275	J	K	M															EN	EN	EN	EH				FE	FE	FE	FG	FH							
3.3 μF	335	J	K	M															ED	ED	ED	EH				FF	FF	FF	FM	FM							
3.9 μF	395	J	K	M															EF	EF	EF	EH				FG	FG	FG	FG	FK							
4.7 μF	475	J	K	M															EF	EF	EF	EH				FC	FC	FC	FG	FS							
5.6 μF	565	J	K	M															EH	EH	EH					FF	FF	FF	FH								
6.8 μF	685	J	K	M															EH	EH	EH					FG	FG	FG	FM								
8.2 μF	825	J	K	M															EH	EH	EH					FH	FH	FH	FK								

Table 2 – Chip Thickness/Packaging Quantities

Thickness Code	Case Size	Thickness ± Range (mm)	Paper Quantity		Plastic Quantity	
			7" Reel	13" Reel	7" Reel	13" Reel
CB	0603	0.80 ± 0.07	4,000	10,000	0	0
CF	0603	0.80 ± 0.07*	4,000	15,000	0	0
CD	0603	0.80 ± 0.15	4,000	10,000	0	0
DC	0805	0.78 ± 0.10	0	0	4,000	10,000
DD	0805	0.90 ± 0.10	0	0	4,000	10,000
DE	0805	1.00 ± 0.10	0	0	2,500	10,000
DG	0805	1.25 ± 0.15	0	0	2,500	10,000
DH	0805	1.25 ± 0.20	0	0	2,500	10,000
EB	1206	0.78 ± 0.10	4,000	10,000	4,000	10,000
EC	1206	0.90 ± 0.10	0	0	4,000	10,000
EN	1206	0.95 ± 0.10	0	0	4,000	10,000
ED	1206	1.00 ± 0.10	0	0	2,500	10,000
EE	1206	1.10 ± 0.10	0	0	2,500	10,000
EF	1206	1.20 ± 0.15	0	0	2,500	10,000
EM	1206	1.25 ± 0.15	0	0	2,500	10,000
EG	1206	1.60 ± 0.15	0	0	2,000	8,000
EH	1206	1.60 ± 0.20	0	0	2,000	8,000
FB	1210	0.78 ± 0.10	0	0	4,000	10,000
FC	1210	0.90 ± 0.10	0	0	4,000	10,000
FD	1210	0.95 ± 0.10	0	0	4,000	10,000
FE	1210	1.00 ± 0.10	0	0	2,500	10,000
FF	1210	1.10 ± 0.10	0	0	2,500	10,000
FG	1210	1.25 ± 0.15	0	0	2,500	10,000
FL	1210	1.40 ± 0.15	0	0	2,000	8,000
FH	1210	1.55 ± 0.15	0	0	2,000	8,000
FM	1210	1.70 ± 0.20	0	0	2,000	8,000
FJ	1210	1.85 ± 0.20	0	0	2,000	8,000
FK	1210	2.10 ± 0.20	0	0	2,000	8,000
FS	1210	2.50 ± 0.30	0	0	1,000	4,000
LD	1808	0.90 ± 0.10	0	0	2,500	10,000
GB	1812	1.00 ± 0.10	0	0	1,000	4,000
GC	1812	1.10 ± 0.10	0	0	1,000	4,000
GE	1812	1.30 ± 0.10	0	0	1,000	4,000
GF	1812	1.50 ± 0.10	0	0	1,000	4,000
GG	1812	1.55 ± 0.10	0	0	1,000	4,000
GK	1812	1.60 ± 0.20	0	0	1,000	4,000
GJ	1812	1.70 ± 0.15	0	0	1,000	4,000
HB	1825	1.10 ± 0.15	0	0	1,000	4,000
HC	1825	1.15 ± 0.15	0	0	1,000	4,000
HD	1825	1.30 ± 0.15	0	0	1,000	4,000
HF	1825	1.50 ± 0.15	0	0	1,000	4,000
JC	2220	1.10 ± 0.15	0	0	1,000	4,000
JD	2220	1.30 ± 0.15	0	0	1,000	4,000
JF	2220	1.50 ± 0.15	0	0	1,000	4,000
JO	2220	2.40 ± 0.15	0	0	500	2,000
KB	2225	1.00 ± 0.15	0	0	1,000	4,000
KC	2225	1.10 ± 0.15	0	0	1,000	4,000
KD	2225	1.30 ± 0.15	0	0	1,000	4,000
KE	2225	1.40 ± 0.15	0	0	1,000	4,000
Thickness Code	Case Size	Thickness ± Range (mm)	7" Reel	13" Reel	7" Reel	13" Reel
			Paper Quantity		Plastic Quantity	

Package quantity based on finished chip thickness specifications.

Table 3 – Chip Capacitor Land Pattern Design Recommendations per IPC–7351

EIA Size Code	Metric Size Code	Density Level A: Maximum (Most) Land Protrusion (mm)					Density Level B: Median (Nominal) Land Protrusion (mm)					Density Level C: Minimum (Least) Land Protrusion (mm)				
		C	Y	X	V1	V2	C	Y	X	V1	V2	C	Y	X	V1	V2
0603	1608	0.85	1.25	1.10	4.00	2.10	0.75	1.05	1.00	3.10	1.50	0.65	0.85	0.90	2.40	1.20
0805	2012	1.00	1.35	1.55	4.40	2.60	0.90	1.15	1.45	3.50	2.00	0.80	0.95	1.35	2.80	1.70
1206	3216	1.60	1.65	1.90	5.90	2.90	1.50	1.45	1.80	5.00	2.30	1.40	1.25	1.70	4.30	2.00
1210	3225	1.60	1.65	2.80	5.90	3.80	1.50	1.45	2.70	5.00	3.20	1.40	1.25	2.60	4.30	2.90
1808	4520	2.25	1.85	2.30	7.40	3.30	2.15	1.65	2.20	6.50	2.70	2.05	1.45	2.10	5.80	2.40
1812	4532	2.10	1.80	3.60	7.00	4.60	2.00	1.60	3.50	6.10	4.00	1.90	1.40	3.40	5.40	3.70
1825	4564	2.15	1.80	6.90	7.10	7.90	2.05	1.60	6.80	6.20	7.30	1.95	1.40	6.70	5.50	7.00
2220	5650	2.85	2.10	5.50	8.80	6.50	2.75	1.90	5.40	7.90	5.90	2.65	1.70	5.30	7.20	5.60
2225	5664	2.85	2.10	6.90	8.80	7.90	2.75	1.90	6.80	7.90	7.30	2.65	1.70	6.70	7.20	7.00

Density Level A: For low-density product applications. Recommended for wave solder applications and provides a wider process window for reflow solder processes. KEMET only recommends wave soldering of EIA 0603, 0805, and 1206 case sizes.

Density Level B: For products with a moderate level of component density. Provides a robust solder attachment condition for reflow solder processes.

Density Level C: For high component density product applications. Before adapting the minimum land pattern variations the user should perform qualification testing based on the conditions outlined in IPC Standard 7351 (IPC–7351).

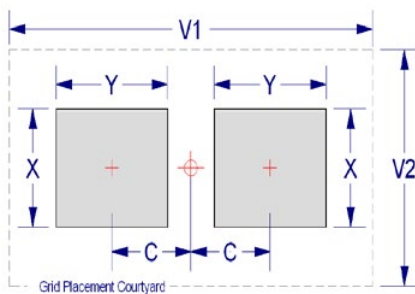

Soldering Process

Recommended Soldering Technique:

- Solder wave or solder reflow for EIA case sizes 0603, 0805, and 1206
- All other EIA case sizes are limited to solder reflow only

Recommended Soldering Profile:

- KEMET recommends following the guidelines outlined in IPC/JEDEC J–STD–020

Table 4 – Performance & Reliability: Test Methods and Conditions

Stress	Reference	Test or Inspection Method
Terminal Strength	JIS-C-6429	Appendix 1, Note: Force of 1.8 kg for 60 seconds.
Board Flex	JIS-C-6429	Appendix 2, Note: Standard termination system – 2.0 mm (minimum) for all except 3 mm for COG. Flexible termination system – 3.0 mm (minimum).
Solderability	J-STD-002	Magnification 50 X. Conditions:
		a) Method B, 4 hours @ 155°C, dry heat @ 235°C
		b) Method B @ 215°C category 3
		c) Method D, category 3 @ 260°C
Temperature Cycling	JESD22 Method JA-104	1,000 Cycles (-55°C to +125°C). Measurement at 24 hours +/- 2 hours after test conclusion.
Biased Humidity	MIL-STD-202 Method 103	Load Humidity: 1,000 hours 85°C/85% RH and rated voltage. Add 100 K ohm resistor. Measurement at 24 hours +/- 2 hours after test conclusion.
		Low Volt Humidity: 1,000 hours 85°C/85% RH and 1.5 V. Add 100 K ohm resistor. Measurement at 24 hours +/- 2 hours after test conclusion.
Moisture Resistance	MIL-STD-202 Method 106	t = 24 hours/cycle. Steps 7a and 7b not required. Unpowered. Measurement at 24 hours +/- 2 hours after test conclusion.
Thermal Shock	MIL-STD-202 Method 107	-55°C/+125°C. Note: Number of cycles required – 300, maximum transfer time – 20 seconds, dwell time – 15 minutes. Air – Air.
High Temperature Life	MIL-STD-202 Method 108 /EIA-198	1,000 hours at 125°C (85°C for X5R, Z5U and Y5V) with 2 X rated voltage applied.
Storage Life	MIL-STD-202 Method 108	150°C, 0 VDC for 1,000 hours.
Vibration	MIL-STD-202 Method 204	5 g's for 20 min., 12 cycles each of 3 orientations. Note: Use 8" X 5" PCB 0.031" thick 7 secure points on one long side and 2 secure points at corners of opposite sides. Parts mounted within 2" from any secure point. Test from 10 – 2,000 Hz
Mechanical Shock	MIL-STD-202 Method 213	Figure 1 of Method 213, Condition F.
Resistance to Solvents	MIL-STD-202 Method 215	Add aqueous wash chemical, OKEM Clean or equivalent.

Storage and Handling

Ceramic chip capacitors should be stored in normal working environments. While the chips themselves are quite robust in other environments, solderability will be degraded by exposure to high temperatures, high humidity, corrosive atmospheres, and long term storage. In addition, packaging materials will be degraded by high temperature– reels may soften or warp and tape peel force may increase. KEMET recommends that maximum storage temperature not exceed 40°C and maximum storage humidity not exceed 70% relative humidity. Temperature fluctuations should be minimized to avoid condensation on the parts and atmospheres should be free of chlorine and sulfur bearing compounds. For optimized solderability chip stock should be used promptly, preferably within 1.5 years of receipt.

Construction

Reference	Item	Material
A	Termination System	Finish
B		Barrier Layer
C		Epoxy Layer
D		Base Metal
E	Inner Electrode	Ni
F	Dielectric Material	BaTiO ₃

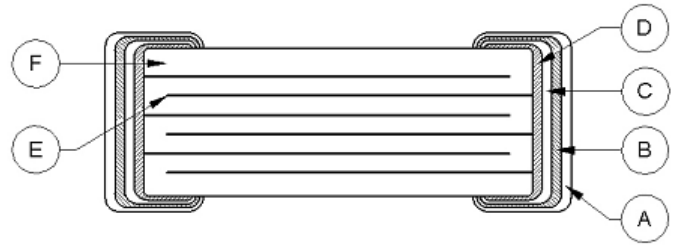

Note: Image is exaggerated in order to clearly identify all components of construction.

Floating Electrode Design with Flexible Termination System (FF-CAP), X7R Dielectric, 6.3 – 250 VDC (Commercial & Automotive Grade)

Overview

KEMET's Floating Electrode with Flexible Termination capacitor (FF-CAP) combines two existing KEMET technologies— Floating Electrode and Flexible Termination. The floating electrode component utilizes a cascading internal electrode design configured to form multiple capacitors in series within a single monolithic structure. This unique configuration results in enhanced voltage and ESD performance over standard capacitor designs while allowing for a fail-open condition if mechanically damaged (cracked). The flexible termination component utilizes a conductive silver epoxy between the base metal and nickel barrier layers of KEMET's standard termination system in order to establish pliability while maintaining terminal strength, solderability and electrical performance. Both technologies address the primary failure mode of MLCCs— flex cracks, which are typically the result of excessive tensile and shear stresses produced during board flexure and thermal cycling.

Although neither technology can eliminate the potential for mechanical damage that may propagate during extreme environmental and/or handling conditions, the combination of these two technologies provide the ultimate level of protection against a low IR or short circuit condition. The FF-CAP complements KEMET's Open Mode, Floating Electrode (FE-CAP), Flexible Termination (FT-CAP) and KEMET Power Solutions (KPS) product lines by providing an ultimate fail-safe design optimized for low to mid range capacitance values. These devices exhibit a predictable change in capacitance with respect to time and voltage and boast a minimal change in capacitance with reference to ambient temperature. Capacitance change is limited to $\pm 15\%$ from -55°C to $+125^{\circ}\text{C}$.

In addition to Commercial Grade, Automotive Grade devices are available which meet the demanding Automotive Electronics Council's AEC-Q200 qualification requirements.

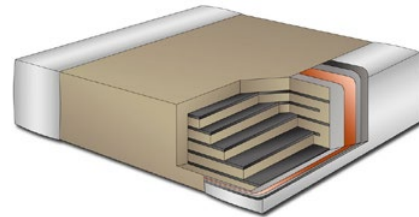

Ordering Information

C	0805	Y	104	K	5	R	A	C	TU
Ceramic	Case Size (L" x W")	Specification/ Series	Capacitance Code (pF)	Capacitance Tolerance	Voltage	Dielectric	Failure Rate/ Design	Termination Finish ¹	Packaging/Grade (C-Spec) ²
	0603 0805 1206 1210 1812	Y = Floating Electrode with Flexible Termination	2 Significant Digits + Number of Zeros	J = $\pm 5\%$ K = $\pm 10\%$ M = $\pm 20\%$	9 = 6.3 V 8 = 10 V 4 = 16 V 3 = 25 V 5 = 50 V 1 = 100 V 2 = 200 V A = 250 V	R = X7R	A = N/A	C = 100% Matte Sn L = SnPb (5% minimum)	Blank = Bulk TU = 7" Reel Unmarked TM = 7" Reel Marked

¹ Additional termination finish options may be available. Contact KEMET for details.

^{1,2} SnPb termination finish option is not available on automotive grade product.

² Additional reeling or packaging options may be available. Contact KEMET for details.

Dimensions – Millimeters (Inches)

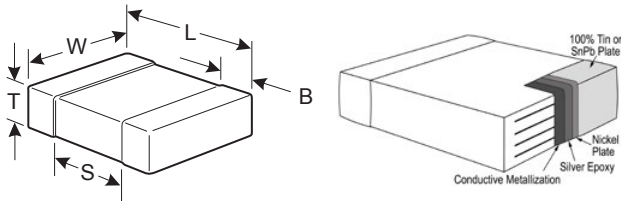

EIA Size Code	Metric Size Code	L Length	W Width	T Thickness	B Bandwidth	S Separation Minimum	Mounting Technique
0603	1608	1.60 (.064) ± 0.17 (.007)	0.80 (.032) ± 0.15 (.006)	See Table 2 for Thickness	0.45 (.018) ± 0.15 (.006)	0.58 (.023)	Solder Wave or Solder Reflow
0805	2012	2.00 (.079) ± 0.20 (.008)	1.25 (.049) ± 0.20 (.008)		0.50 (0.02) ± 0.25 (.010)	0.75 (.030)	
1206	3216	3.30 (.130) ± 0.40 (.016)	1.60 (.063) ± 0.20 (.008)		0.60 (.024) ± 0.25 (.010)	N/A	Solder Reflow Only
1210	3225	3.30 (.130) ± 0.40 (.016)	2.50 (.098) ± 0.20 (.008)		0.60 (.024) ± 0.25 (.010)		
1812	4532	4.50 (.178) ± 0.40 (.016)	3.20 (.126) ± 0.30 (.012)		0.70 (.028) ± 0.35 (.014)		

Benefits

- -55°C to +125°C operating temperature range
- Superior flex performance (up to 5 mm)
- Floating Electrode/fail open design
- Low to mid capacitance flex mitigation
- Pb-Free and RoHS Compliant
- EIA 0603, 0805, 1206, 1210, and 1812 case sizes
- DC voltage ratings of 6.3 V, 10 V, 16 V, 25 V, 50 V, 100 V, 200 V, and 250 V
- Capacitance offerings ranging from 180 pF to 0.22 μF
- Available capacitance tolerances of ±5%, ±10%, and ±20%
- Commercial & Automotive (AEC-Q200) grades available
- Non-polar device, minimizing installation concerns
- 100% pure matte tin-plated termination finish allowing for excellent solderability
- SnPb termination finish option available upon request (5% minimum)

Applications

Typical applications include circuits with a direct battery or power source connection, critical and safety relevant circuits without (integrated) current limitation and any application that is subject to high levels of board flexure or temperature cycling. Examples include raw power input side filtering (power plane/bus), high current applications (automobile battery line) and circuits that cannot be fused to open. Markets include consumer, medical, industrial (power supply), automotive, aerospace and telecom.

Qualification/Certification

Commercial Grade products are subject to internal qualification. Details regarding test methods and conditions are referenced in Table 4, Performance & Reliability.

Automotive Grade products meet or exceed the requirements outlined by the Automotive Electronics Council. Details regarding test methods and conditions are referenced in document AEC-Q200, Stress Test Qualification for Passive Components. For additional information regarding the Automotive Electronics Council and AEC-Q200, please visit their website at www.aecouncil.com.

Environmental Compliance

Pb-Free and RoHS Compliant (excluding SnPb termination finish option).



RoHS Compliant

Electrical Parameters/Characteristics

Item	Parameters/Characteristics
Operating Temperature Range	-55°C to +125°C
Capacitance Change with Reference to +25°C and 0 VDC Applied (TCC)	±15%
Aging Rate (Maximum % Capacitance Loss/Decade Hour)	3.0%
Dielectric Withstanding Voltage	250% of rated voltage (5 ±1 seconds and charge/discharge not exceeding 50 mA)
Dissipation Factor (DF) Maximum Limit @ 25°C	5% (6.3 and 10 V), 3.5% (16 and 25 V) and 2.5% (50 to 250 V)
Insulation Resistance (IR) Limit @ 25°C	See Insulation Resistance Limit Table (Rated voltage applied for 120 ±5 seconds @ 25°C)

Regarding aging rate: Capacitance measurements (including tolerance) are indexed to a referee time of 1,000 hours.

To obtain IR limit, divide $M\Omega \cdot \mu F$ value by the capacitance and compare to $G\Omega$ limit. Select the lower of the two limits.

Capacitance and dissipation factor (DF) measured under the following conditions:

1 kHz ±50 Hz and 1.0 ±0.2 Vrms if capacitance ≤ 10 μF

120 Hz ±10 Hz and 0.5 ±0.1 Vrms if capacitance > 10 μF

Note: When measuring capacitance it is important to ensure the set voltage level is held constant. The HP4284 and Agilent E4980 have a feature known as Automatic Level Control (ALC). The ALC feature should be switched to "ON."

Post Environmental Limits

High Temperature Life, Biased Humidity, Moisture Resistance					
Dielectric	Rated DC Voltage	Capacitance Value	Dissipation Factor (Maximum %)	Capacitance Shift	Insulation Resistance
X7R	> 25	All	3.0	±20%	10% of Initial Limit
	16/25		5.0		
	< 16		7.5		

Insulation Resistance Limit Table (X7R Dielectric)

EIA Case Size	1,000 Megohm Microfarads or 100 GΩ	500 Megohm Microfarads or 10 GΩ
0201	N/A	ALL
0402	< 0.012 μF	≥ 0.012 μF
0603	< 0.047 μF	≥ 0.047 μF
0805	< 0.047 μF	≥ 0.047 μF
1206	< 0.22 μF	≥ 0.22 μF
1210	< 0.39 μF	≥ 0.39 μF
1808	ALL	N/A
1812	< 2.2 μF	≥ 2.2 μF
1825	ALL	N/A
2220	< 10 μF	≥ 10 μF
2225	ALL	N/A

Table 1A – Capacitance Range/Selection Waterfall (0603 – 0805 Case Sizes)

Capacitance	Cap Code	Case Size / Series			C0603Y								C0805Y							
		Voltage Code			9	8	4	3	5	1	2	9	8	4	3	5	1	2	A	
		Rated Voltage (VDC)			6.3	10	16	25	50	100	200	6.3	10	16	25	50	100	200	250	
		Capacitance Tolerance			Product Availability and Chip Thickness Codes See Table 2 for Chip Thickness Dimensions															
180 pF	181	J	K	M	CB	CB	CB	CB	CB	CB	CB	DC	DC	DC	DC	DC	DC	DC	DC	
220 pF	221	J	K	M	CB	CB	CB	CB	CB	CB	CB	DC	DC	DC	DC	DC	DC	DC	DC	
270 pF	271	J	K	M	CB	CB	CB	CB	CB	CB	CB	DC	DC	DC	DC	DC	DC	DC	DC	
330 pF	331	J	K	M	CB	CB	CB	CB	CB	CB	CB	DC	DC	DC	DC	DC	DC	DC	DC	
390 pF	391	J	K	M	CB	CB	CB	CB	CB	CB	CB	DC	DC	DC	DC	DC	DC	DC	DC	
470 pF	471	J	K	M	CB	CB	CB	CB	CB	CB	CB	DC	DC	DC	DC	DC	DC	DC	DC	
560 pF	561	J	K	M	CB	CB	CB	CB	CB	CB	CB	DC	DC	DC	DC	DC	DC	DC	DC	
680 pF	681	J	K	M	CB	CB	CB	CB	CB	CB	CB	DC	DC	DC	DC	DC	DC	DC	DC	
820 pF	821	J	K	M	CB	CB	CB	CB	CB	CB	CB	DC	DC	DC	DC	DC	DC	DC	DC	
1,000 pF	102	J	K	M	CB	CB	CB	CB	CB	CF	CB	DC	DC	DC	DC	DC	DC	DC	DC	
1,200 pF	122	J	K	M	CB	CB	CB	CB	CB	CB	CB	DC	DC	DC	DC	DC	DC	DC	DC	
1,500 pF	152	J	K	M	CB	CB	CB	CB	CB	CB	CB	DC	DC	DC	DC	DC	DC	DC	DC	
1,800 pF	182	J	K	M	CB	CB	CB	CB	CB	CB	CB	DC	DC	DC	DC	DC	DC	DC	DC	
2,200 pF	222	J	K	M	CB	CB	CB	CB	CB	CF	CB	DC	DC	DC	DC	DC	DC	DC	DC	
2,700 pF	272	J	K	M	CB	CB	CB	CB	CB	CF	CB	DC	DC	DC	DC	DC	DC	DC	DC	
3,300 pF	332	J	K	M	CB	CB	CB	CB	CB	CB	CB	DC	DC	DC	DC	DC	DC	DC	DC	
3,900 pF	392	J	K	M	CB	CB	CB	CB	CB	CB	CB	DC	DC	DC	DC	DC	DC	DC	DC	
4,700 pF	472	J	K	M	CB	CB	CB	CB	CB	CB	CB	DC	DC	DC	DC	DC	DC	DC	DC	
5,600 pF	562	J	K	M	CB	CB	CB	CB	CB	CB	CB	DC	DC	DC	DC	DC	DC	DC	DC	
6,800 pF	682	J	K	M	CB	CB	CB	CB	CB	CB	CB	DC	DC	DC	DC	DC	DC	DC	DC	
8,200 pF	822	J	K	M	CB	CB	CB	CB	CB	CB	CB	DC	DC	DC	DC	DC	DC	DC	DC	
10,000 pF	103	J	K	M	CB	CB	CB	CB	CB	CF	CB	DC	DC	DC	DC	DC	DC	DC	DC	
12,000 pF	123	J	K	M	CB	CB	CB	CB	CB	CB	CB	DC	DC	DC	DC	DC	DC	DC	DC	
15,000 pF	153	J	K	M	CB	CB	CB	CB	CB	CB	CB	DC	DC	DC	DC	DC	DD	DD	DD	
18,000 pF	183	J	K	M	CB	CB	CB	CB	CB	CB	CB	DC	DC	DC	DC	DC	DD	DD	DD	
22,000 pF	223	J	K	M	CB	CB	CB	CB	CB	CB	CB	DC	DC	DC	DC	DC	DD	DD	DD	
27,000 pF	273	J	K	M								DC	DC	DC	DC	DC				
33,000 pF	333	J	K	M								DC	DC	DC	DC	DC				
39,000 pF	393	J	K	M								DC	DC	DC	DC	DC				
47,000 pF	473	J	K	M								DC	DC	DC	DC	DC				
56,000 pF	563	J	K	M								DD	DD	DD	DD	DD				
68,000 pF	683	J	K	M								DD	DD	DD	DD	DD				
82,000 pF	823	J	K	M								DG	DG	DG	DG	DG				
0.10 µF	104	J	K	M								DG	DG	DG	DG	DG				
Capacitance	Cap Code	Rated Voltage (VDC)			6.3	10	16	25	50	100	200	6.3	10	16	25	50	100	200	250	
		Voltage Code			9	8	4	3	5	1	2	9	8	4	3	5	1	2	A	
		Case Size / Series			C0603Y								C0805Y							

Table 2 – Chip Thickness/Packaging Quantities

Thickness Code	Case Size	Thickness ± Range (mm)	Paper Quantity		Plastic Quantity	
			7" Reel	13" Reel	7" Reel	13" Reel
CB	0603	0.80 ± 0.07	4,000	10,000	0	0
CF	0603	0.80 ± 0.07	4,000	15,000	0	0
DC	0805	0.78 ± 0.10	0	0	4,000	10,000
DD	0805	0.90 ± 0.10	0	0	4,000	10,000
DG	0805	1.25 ± 0.15	0	0	2,500	10,000
EB	1206	0.78 ± 0.10	4,000	10,000	4,000	10,000
EC	1206	0.90 ± 0.10	0	0	4,000	10,000
FB	1210	0.78 ± 0.10	0	0	4,000	10,000
FC	1210	0.90 ± 0.10	0	0	4,000	10,000
FD	1210	0.95 ± 0.10	0	0	4,000	10,000
GB	1812	1.00 ± 0.10	0	0	1,000	4,000
Thickness Code	Case Size	Thickness ± Range (mm)	7" Reel	13" Reel	7" Reel	13" Reel
			Paper Quantity		Plastic Quantity	

Package quantity based on finished chip thickness specifications.

Table 3 – Chip Capacitor Land Pattern Design Recommendations per IPC–7351

EIA Size Code	Metric Size Code	Density Level A: Maximum (Most) Land Protrusion (mm)					Density Level B: Median (Nominal) Land Protrusion (mm)					Density Level C: Minimum (Least) Land Protrusion (mm)				
		C	Y	X	V1	V2	C	Y	X	V1	V2	C	Y	X	V1	V2
0603	1608	0.85	1.25	1.10	4.00	2.10	0.75	1.05	1.00	3.10	1.50	0.65	0.85	0.90	2.40	1.20
0805	2012	1.00	1.35	1.55	4.40	2.60	0.90	1.15	1.45	3.50	2.00	0.80	0.95	1.35	2.80	1.70
1206	3216	1.60	1.65	1.90	5.90	2.90	1.50	1.45	1.80	5.00	2.30	1.40	1.25	1.70	4.30	2.00
1210	3225	1.60	1.65	2.80	5.90	3.80	1.50	1.45	2.70	5.00	3.20	1.40	1.25	2.60	4.30	2.90
1812	4532	2.10	1.80	3.60	7.00	4.60	2.00	1.60	3.50	6.10	4.00	1.90	1.40	3.40	5.40	3.70

Density Level A: For low-density product applications. Recommended for wave solder applications and provides a wider process window for reflow solder processes. KEMET only recommends wave soldering of EIA 0603, 0805 and 1206 case sizes.

Density Level B: For products with a moderate level of component density. Provides a robust solder attachment condition for reflow solder processes.

Density Level C: For high component density product applications. Before adapting the minimum land pattern variations the user should perform qualification testing based on the conditions outlined in IPC Standard 7351 (IPC–7351).

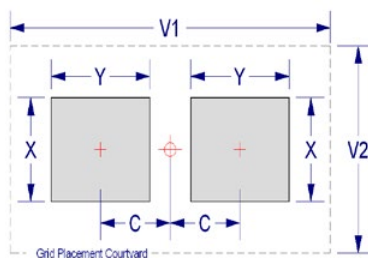

Soldering Process

Recommended Soldering Technique:

- Solder wave or solder reflow for EIA case sizes 0603, 0805 and 1206
- All other EIA case sizes are limited to solder reflow only

Recommended Soldering Profile:

- KEMET recommends following the guidelines outlined in IPC/JEDEC J-STD-020

Table 4 – Performance & Reliability: Test Methods and Conditions

Stress	Reference	Test or Inspection Method
Terminal Strength	JIS-C-6429	Appendix 1, Note: Force of 1.8 kg for 60 seconds.
Board Flex	JIS-C-6429	Appendix 2, Note: Standard termination system – 2.0 mm (minimum) for all except 3 mm for COG. Flexible termination system – 3.0 mm (minimum).
Solderability	J-STD-002	Magnification 50 X. Conditions:
		a) Method B, 4 hours @ 155°C, dry heat @ 235°C
		b) Method B @ 215°C category 3
		c) Method D, category 3 @ 260°C
Temperature Cycling	JESD22 Method JA-104	1,000 Cycles (-55°C to +125°C). Measurement at 24 hours +/- 2 hours after test conclusion.
Biased Humidity	MIL-STD-202 Method 103	Load Humidity: 1,000 hours 85°C/85% RH and rated voltage. Add 100 K ohm resistor. Measurement at 24 hours +/- 2 hours after test conclusion.
		Low Volt Humidity: 1,000 hours 85°C/85% RH and 1.5 V. Add 100 K ohm resistor. Measurement at 24 hours +/- 2 hours after test conclusion.
Moisture Resistance	MIL-STD-202 Method 106	t = 24 hours/cycle. Steps 7a and 7b not required. Unpowered. Measurement at 24 hours +/- 2 hours after test conclusion.
Thermal Shock	MIL-STD-202 Method 107	-55°C/+125°C. Note: Number of cycles required – 300, maximum transfer time – 20 seconds, dwell time – 15 minutes. Air – Air.
High Temperature Life	MIL-STD-202 Method 108 /EIA-198	1,000 hours at 125°C (85°C for X5R, Z5U and Y5V) with 2 X rated voltage applied.
Storage Life	MIL-STD-202 Method 108	150°C, 0 VDC for 1,000 hours.
Vibration	MIL-STD-202 Method 204	5 g's for 20 min., 12 cycles each of 3 orientations. Note: Use 8" X 5" PCB 0.031" thick 7 secure points on one long side and 2 secure points at corners of opposite sides. Parts mounted within 2" from any secure point. Test from 10 – 2,000 Hz
Mechanical Shock	MIL-STD-202 Method 213	Figure 1 of Method 213, Condition F.
Resistance to Solvents	MIL-STD-202 Method 215	Add aqueous wash chemical, OKEM Clean or equivalent.

Storage and Handling

Ceramic chip capacitors should be stored in normal working environments. While the chips themselves are quite robust in other environments, solderability will be degraded by exposure to high temperatures, high humidity, corrosive atmospheres, and long term storage. In addition, packaging materials will be degraded by high temperature– reels may soften or warp and tape peel force may increase. KEMET recommends that maximum storage temperature not exceed 40°C and maximum storage humidity not exceed 70% relative humidity. Temperature fluctuations should be minimized to avoid condensation on the parts and atmospheres should be free of chlorine and sulfur bearing compounds. For optimized solderability chip stock should be used promptly, preferably within 1.5 years of receipt.

Construction

Reference	Item	Material
A	Termination System	Finish 100% Matte Sn SnPb (5% min)
B		Barrier Layer Ni
C		Epoxy Layer Ag
D		Base Metal Cu
E	Inner Electrode	Ni
F	Dielectric Material	BaTiO ₃

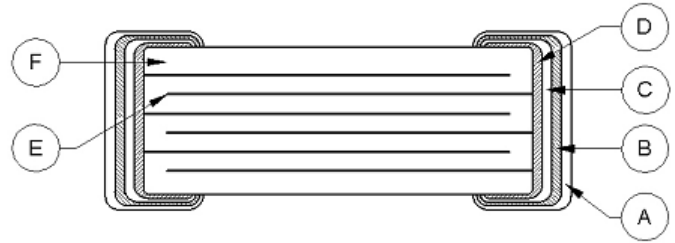

Note: Image is exaggerated in order to clearly identify all components of construction.

Overview

KEMET Power Solutions (KPS) Commercial Series stacked capacitors utilize a proprietary lead-frame technology to vertically stack one or two multilayer ceramic chip capacitors into a single compact surface mount package. The attached lead-frame mechanically isolates the capacitor/s from the printed circuit board, therefore offering advanced mechanical and thermal stress performance. Isolation also addresses concerns for audible, microphonic noise that may occur when a bias voltage is applied. A two chip stack offers up to double the capacitance in the same or smaller design footprint when compared to traditional surface mount MLCCs devices. Providing up to 10 mm of board flex capability, KPS Series

capacitors are environmentally friendly and in compliance with RoHS legislation. Available in X7R dielectric, these devices are capable of Pb-Free reflow profiles and provide lower ESR, ESL and higher ripple current capability when compared to other dielectric solutions.

Combined with the stability of an X7R dielectric, KEMET's KPS Series devices exhibit a predictable change in capacitance with respect to time and voltage and boast a minimal change in capacitance with reference to ambient temperature. Capacitance change is limited to $\pm 15\%$ from -55°C to $+125^{\circ}\text{C}$.

Benefits

- -55°C to $+125^{\circ}\text{C}$ operating temperature range
- Reliable and robust termination system
- EIA 1210, 1812, and 2220 case sizes
- DC voltage ratings of 10 V, 16 V, 25 V, 50 V, 100 V, and 250 V
- Capacitance offerings ranging from 0.1 μF up to 47 μF
- Available capacitance tolerances of $\pm 10\%$ and $\pm 20\%$
- Higher capacitance in the same footprint
- Potential board space savings
- Advanced protection against thermal and mechanical stress
- Provides up to 10 mm of board flex capability
- Reduces audible, microphonic noise
- Extremely low ESR and ESL
- Pb-Free and RoHS Compliant
- Capable of Pb-Free reflow profiles
- Non-polar device, minimizing installation concerns
- Tantalum and electrolytic alternative

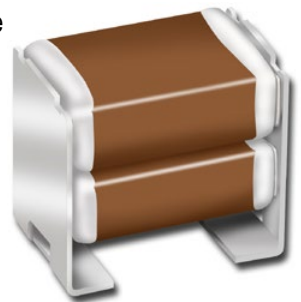

Ordering Information

C	2210	C	106	M	5	R	2	C	7186
Ceramic	Case Size (L" x W")	Specification/ Series	Capacitance Code (pF)	Capacitance Tolerance ¹	Voltage	Dielectric	Failure Rate/Design	Leadframe Finish ²	Packaging/Grade (C-Spec) ³
	1210 1812 2220	C = Standard	2 significant digits + number of zeros	K = $\pm 10\%$ M = $\pm 20\%$	8 = 10 V 4 = 16 V 3 = 25 V 5 = 50 V 1 = 100 V A = 250 V	R = X7R	1 = KPS Single Chip Stack 2 = KPS Double Chip Stack	C = 100% Matte Sn	7186 = 7" Reel Unmarked 7289 = 13" Reel Unmarked

¹ Double chip stacks ("2" in the 13th character position of the ordering code) are only available in M ($\pm 20\%$) capacitance tolerance. Single chip stacks ("1" in the 13th character position of the ordering code) are available in K ($\pm 10\%$) or M ($\pm 20\%$) tolerances.

² Additional leadframe finish options may be available. Contact KEMET for details.

³ Additional reeling or packaging options may be available. Contact KEMET for details.

Dimensions – Millimeters (Inches)

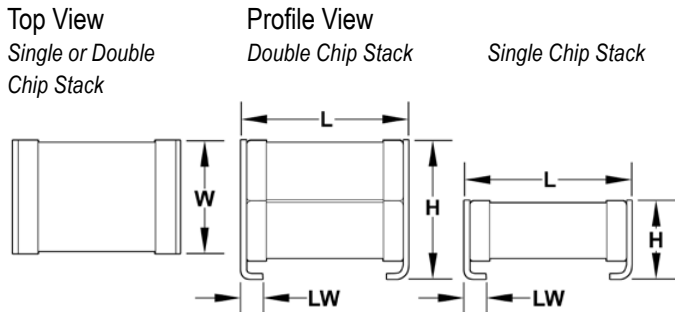

Number of Chips	EIA Size Code	Metric Size Code	L Length	W Width	H Height	LW Lead Width	Mounting Technique
Single	1210	3225	3.50 (.138) ±0.30 (.012)	2.60 (.102) ±0.30 (.012)	3.35 (.132) ±0.10 (.004)	0.80 (.032) ±0.15 (.006)	Solder Reflow Only
	1812	4532	5.00 (.197) ±0.50 (.020)	3.50 (.138) ±0.50 (.020)	2.65 (.104) ±0.35 (.014)	1.10 (.043) ±0.30 (.012)	
	2220	5650	6.00 (.236) ±0.50 (.020)	5.00 (.197) ±0.50 (.020)	3.50 (.138) ±0.30 (.012)	1.60 (.063) ±0.30 (.012)	
Double	1210	3225	3.50 (.138) ±0.30 (.012)	2.60 (.102) ±0.30 (.012)	6.15 (.242) ±0.15 (.006)	0.80 (.031) ±0.15 (.006)	
	1812	4532	5.00 (.197) ±0.50 (.020)	3.50 (.138) ±0.50 (.020)	5.00 (.197) ±0.50 (.020)	1.10 (.043) ±0.30 (.012)	
	2220	5650	6.00 (.236) ±0.50 (.020)	5.00 (.197) ±0.50 (.020)	5.00 (.197) ±0.50 (.020)	1.60 (.063) ±0.30 (.012)	

Applications

Typical applications include smoothing circuits, DC/DC converters, power supplies (input/output filters), noise reduction (piezoelectric/mechanical), circuits with a direct battery or power source connection, critical and safety relevant circuits without (integrated) current limitation and any application that is subject to high levels of board flexure or temperature cycling. Markets include industrial, military, automotive and telecom.

Qualification/Certification

Commercial Grade products are subject to internal qualification. Details regarding test methods and conditions are referenced in Table 4, Performance & Reliability.

Environmental Compliance

Pb-Free and RoHS Compliant.



RoHS Compliant

Electrical Parameters/Characteristics

Item	Parameters/Characteristics
Operating Temperature Range	-55°C to +125°C
Capacitance Change with Reference to +25°C and 0 VDC Applied (TCC)	±15%
Aging Rate (Maximum % Capacitance Loss/Decade Hour)	3.0%
Dielectric Withstanding Voltage (DWV)	250% of rated voltage (5 ±1 seconds and charge/discharge not exceeding 50 mA)
Dissipation Factor (DF) Maximum Limit @ 25°C	5%(10 V), 3.5%(16 V and 25 V) and 2.5%(50 V to 250 V)
Insulation Resistance (IR) Limit @ 25°C	See Insulation Resistance Limit Table (Rated voltage applied for 120 ±5 seconds @ 25°C)

Regarding aging rate: Capacitance measurements (including tolerance) are indexed to a referee time of 48 or 1,000 hours. Please refer to a part number specific datasheet for referee time details.

To obtain IR limit, divide $M\Omega \cdot \mu F$ value by the capacitance and compare to $G\Omega$ limit. Select the lower of the two limits.

Capacitance and dissipation factor (DF) measured under the following conditions:

1 kHz ±50 Hz and 1.0 ±0.2 Vrms if capacitance ≤ 10 μF

120 Hz ±10 Hz and 0.5 ±0.1 Vrms if capacitance > 10 μF

Note: When measuring capacitance it is important to ensure the set voltage level is held constant. The HP4284 and Agilent E4980 have a feature known as Automatic Level Control (ALC). The ALC feature should be switched to "ON."

Post Environmental Limits

High Temperature Life, Biased Humidity, Moisture Resistance					
Dielectric	Rated DC Voltage	Capacitance Value	Dissipation Factor (Maximum %)	Capacitance Shift	Insulation Resistance
X7R	> 25	All	3.0	±20%	10% of Initial Limit
	16/25		5.0		
	< 16		7.5		

Insulation Resistance Limit Table

EIA Case Size	1,000 Megohm Microfarads or 100 GΩ	500 Megohm Microfarads or 10 GΩ
1210	< 0.39 μF	≥ 0.39 μF
1812	< 2.2 μF	≥ 2.2 μF
2220	< 10 μF	≥ 10 μF

Electrical Characteristics

Z and ESR C1210C475M5R1C

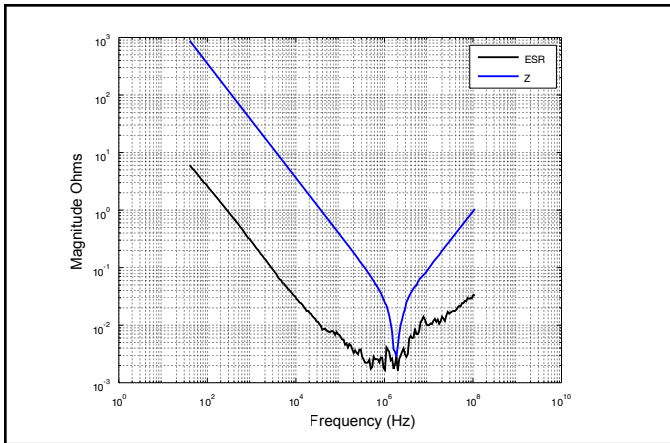

Z and ESR C2220C225MAR2C

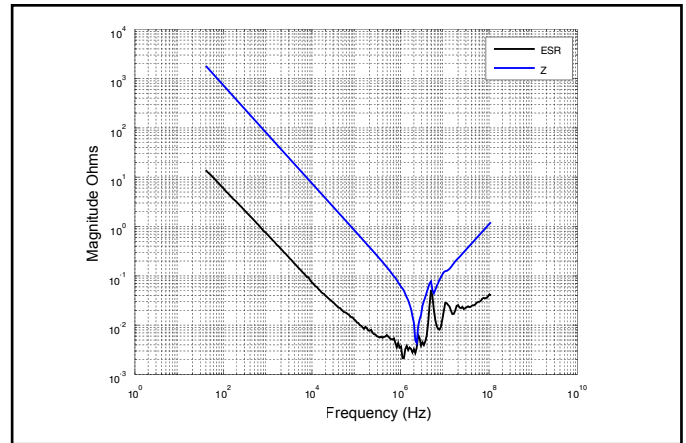

Z and ESR C2220C476M3R2C

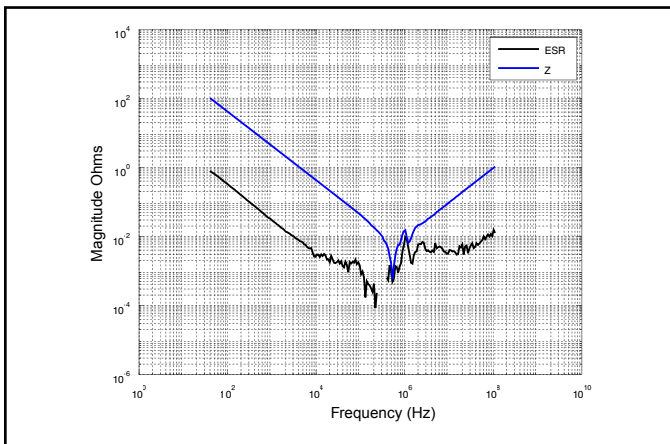

Electrical Characteristics cont'd

ESR – 1812, .10 μ F, 50 V X7R

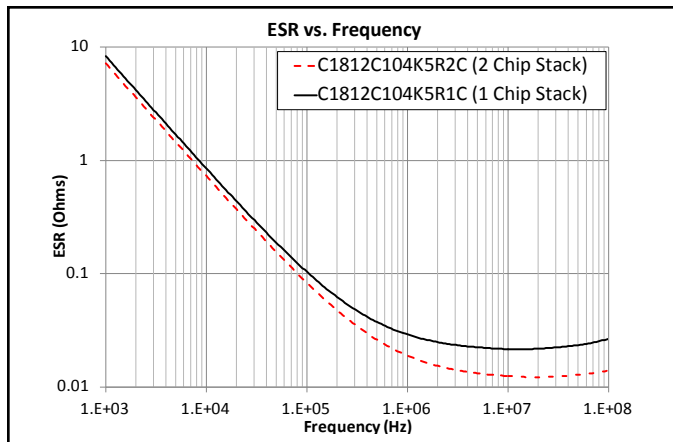

Impedance – 1812, .10 μ F, 50 V X7R

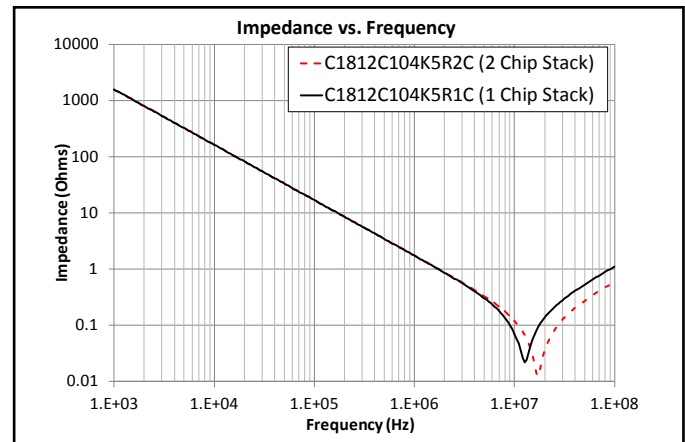

ESR – 1210, .22 μ F, 50 V X7R

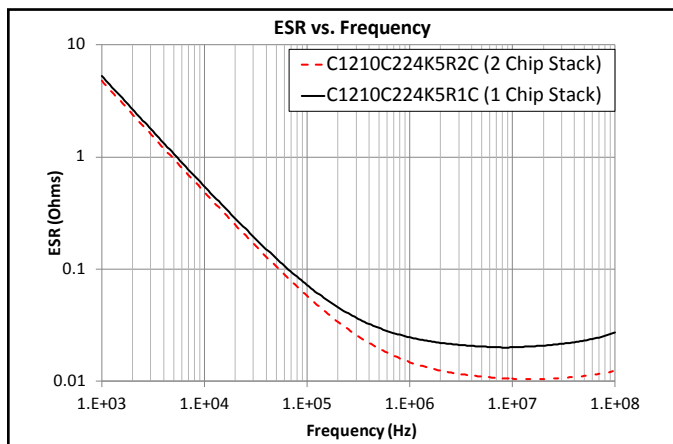

Impedance – 1210, .22 μ F, 50 V X7R

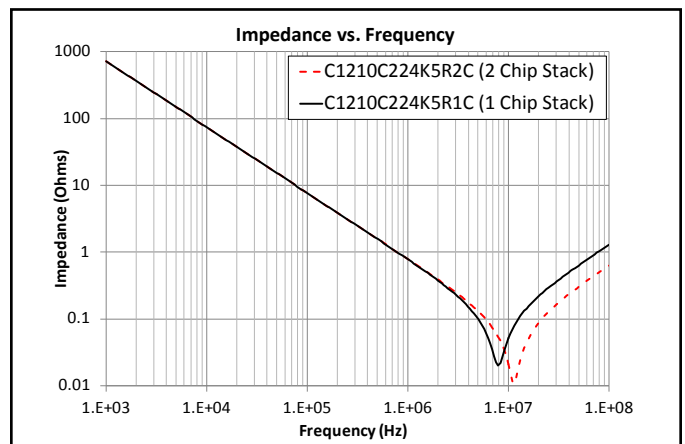

Electrical Characteristics cont'd

Microphonics – 1210, 4.7 μ F, 50 V, X7R

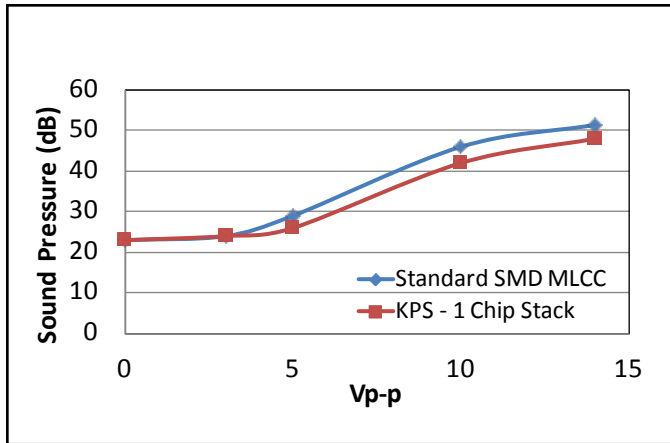

Microphonics – 2220, 22 μ F, 50 V, X7R

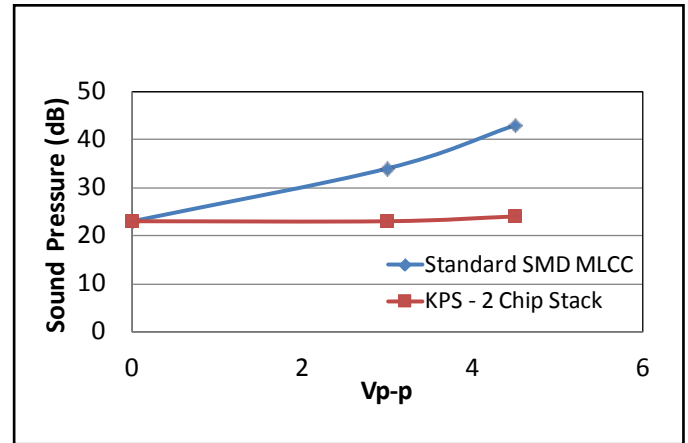

Microphonics – 2220, 47 μ F, 25 V, X7R

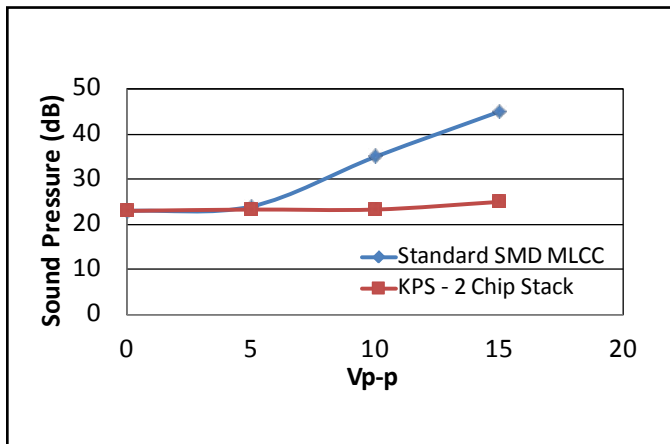

Microphonics – 1210, 22 μ F, 25 V, X7R

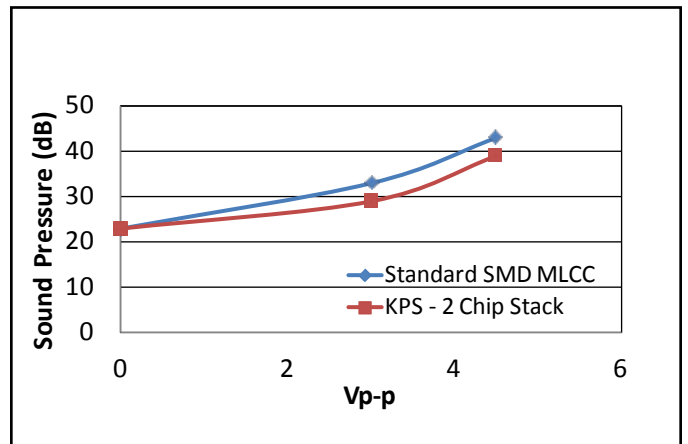

Competitive Comparison

Microphonics – 1210, 4.7 μ F, 50 V, X7R

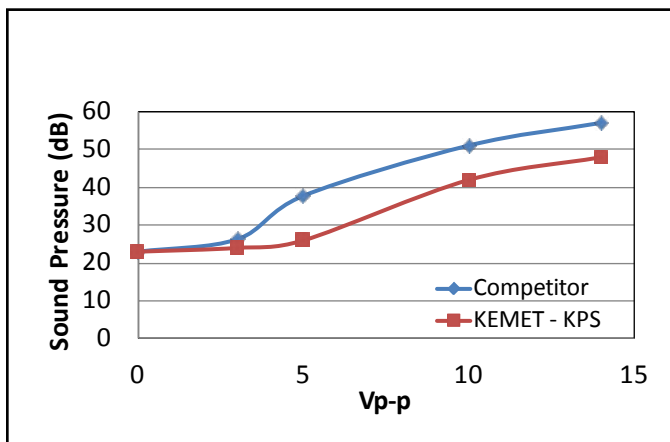

Ripple Current (Arms) 2220, 22 μ F, 50 V

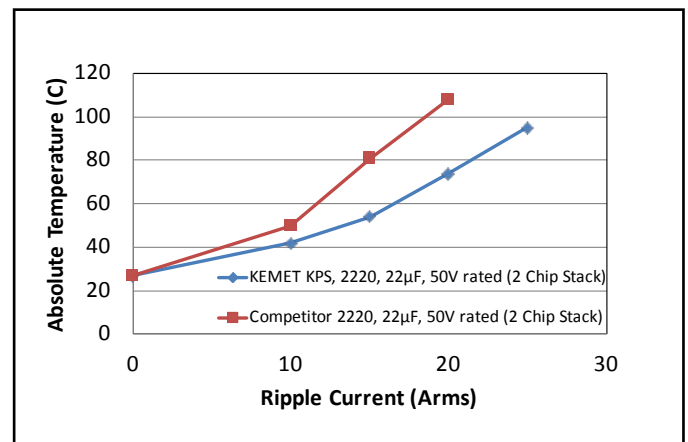

Note: Refer to Table 4 for test method.

Electrical Characteristics cont'd

Board Flex vs. Termination Type

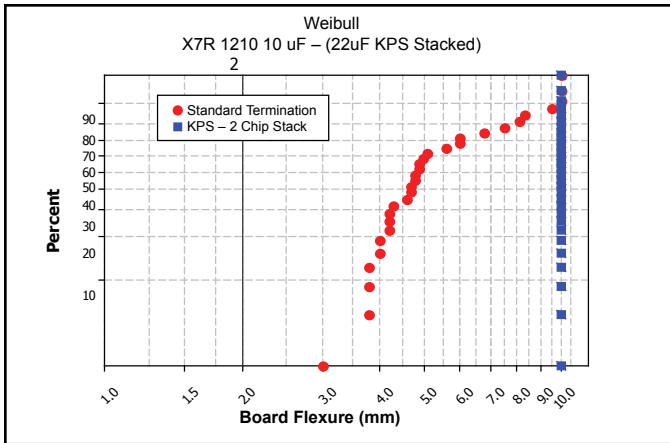

Board Flex vs. Termination Type

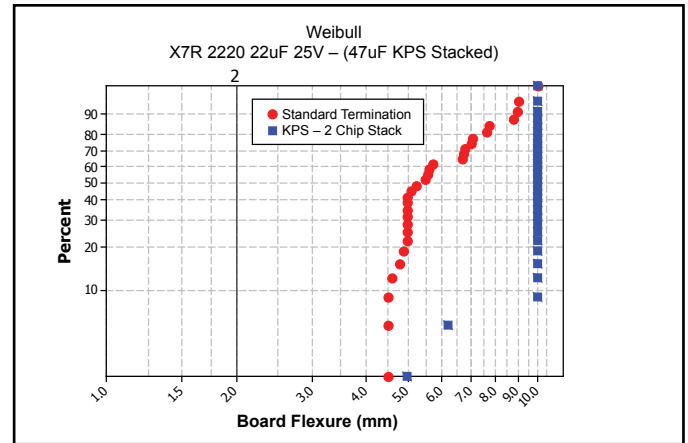

Board Flexure to 10 mm

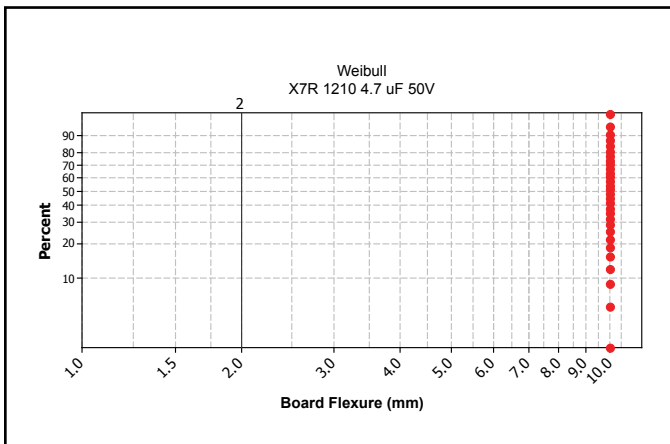

Board Flexure to 10 mm

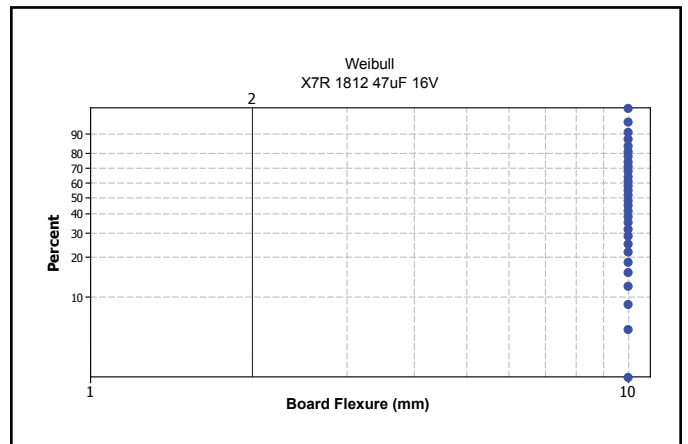

Table 1 – Capacitance Range/Selection Waterfall (1210 – 2220 Case Sizes)

Capacitance	Cap Code	Case Size / Series		C1210C						C1812C					C2220C				
		Voltage Code		8	4	3	5	1	A	4	3	5	1	A	4	3	5	1	A
		Rated Voltage (VDC)		10	16	25	50	100	250	16	25	50	100	250	16	25	50	100	250
		Capacitance Tolerance		Product Availability and Chip Thickness Codes See Table 2 for Chip Thickness Dimensions															
Single Chip Stack																			
0.10 µF	104	K	M	FV	FV	FV	FV	FV	FV	GP	GP	GP	GP	GP	JP	JP	JP	JP	JP
0.22 µF	224	K	M	FV	FV	FV	FV	FV	FV	GP	GP	GP	GP	GP	JP	JP	JP	JP	JP
0.47 µF	474	K	M	FV	FV	FV	FV	FV	FV	GP	GP	GP	GP	GP	JP	JP	JP	JP	JP
1.0 µF	105	K	M	FV	FV	FV	FV	FV	FV	GP	GP	GP	GP	GP	JP	JP	JP	JP	JP
2.2 µF	225	K	M	FV	FV	FV	FV	FV	FV	GP	GP	GP	GP	GP	JP	JP	JP	JP	JP
3.3 µF	335	K	M	FV	FV	FV	FV	FV	FV	GP	GP	GP	GP	GP	JP	JP	JP	JP	JP
4.7 µF	475	K	M	FV	FV	FV	FV	FV	FV	GP	GP	GP	GP	GP	JP	JP	JP	JP	JP
10 µF	106	K	M	FV	FV	FV	FV	FV	FV	GP	GP	GP	GP	GP	JP	JP	JP	JP	JP
15 µF	156	K	M	FV	FV	FV	FV	FV	FV	GP	GP	GP	GP	GP	JP	JP	JP	JP	JP
22 µF	226	K	M	FV	FV	FV	FV	FV	FV	GP	GP	GP	GP	GP	JP	JP	JP	JP	JP
33 µF	336	K	M	FV	FV	FV	FV	FV	FV	GP	GP	GP	GP	GP	JP	JP	JP	JP	JP
47 µF	476	K	M	FV	FV	FV	FV	FV	FV	GP	GP	GP	GP	GP	JP	JP	JP	JP	JP
100 µF	107	K	M	FV	FV	FV	FV	FV	FV	GP	GP	GP	GP	GP	JP	JP	JP	JP	JP
Double Chip Stack																			
0.10 µF	104		M	FW	FW	FW	FW	FW	FW	GR	GR	GR	GR	GR	JR	JR	JR	JR	JR
0.22 µF	224		M	FW	FW	FW	FW	FW	FW	GR	GR	GR	GR	GR	JR	JR	JR	JR	JR
0.47 µF	474		M	FW	FW	FW	FW	FW	FW	GR	GR	GR	GR	GR	JR	JR	JR	JR	JR
1.0 µF	105		M	FW	FW	FW	FW	FW	FW	GR	GR	GR	GR	GR	JR	JR	JR	JR	JR
2.2 µF	225		M	FW	FW	FW	FW	FW	FW	GR	GR	GR	GR	GR	JR	JR	JR	JR	JR
3.3 µF	335		M	FW	FW	FW	FW	FW	FW	GR	GR	GR	GR	GR	JR	JR	JR	JR	JR
4.7 µF	475		M	FW	FW	FW	FW	FW	FW	GR	GR	GR	GR	GR	JR	JR	JR	JR	JR
10 µF	106		M	FW	FW	FW	FW	FW	FW	GR	GR	GR	GR	GR	JR	JR	JR	JR	JR
22 µF	226		M	FW	FW	FW	FW	FW	FW	GR	GR	GR	GR	GR	JR	JR	JR	JR	JR
33 µF	336		M	FW	FW	FW	FW	FW	FW	GR	GR	GR	GR	GR	JR	JR	JR	JR	JR
47 µF	476		M	FW	FW	FW	FW	FW	FW	GR	GR	GR	GR	GR	JR	JR	JR	JR	JR
100 µF	107		M	FW	FW	FW	FW	FW	FW	GR	GR	GR	GR	GR	JR	JR	JR	JR	JR
220 µF	227		M	FW	FW	FW	FW	FW	FW	GR	GR	GR	GR	GR	JR	JR	JR	JR	JR
Capacitance	Cap Code	Rated Voltage (VDC)		10	16	25	50	100	250	16	25	50	100	250	16	25	50	100	250
		Voltage Code		8	4	3	5	1	A	4	3	5	1	A	4	3	5	1	A
		Case Size / Series		C1210C						C1812C					C2220C				

These products are protected under US Patent 8,331,078 other patents pending, and any foreign counterparts.

Table 2 – Chip Thickness/Packaging Quantities

Thickness Code	Case Size	Thickness ± Range (mm)	Paper Quantity		Plastic Quantity	
			7" Reel	13" Reel	7" Reel	13" Reel
FV	1210	3.35 ± 0.10	0	0	600	2,000
FW	1210	6.15 ± 0.15	0	0	300	1,000
GP	1812	2.65 ± 0.35	0	0	500	2,000
GR	1812	5.00 ± 0.50	0	0	400	1,700
JP	2220	3.50 ± 0.30	0	0	300	1,300
JR	2220	5.00 ± 0.50	0	0	200	800
Thickness Code	Case Size	Thickness ± Range (mm)	7" Reel	13" Reel	7" Reel	13" Reel
			Paper Quantity		Plastic Quantity	

Package quantity based on finished chip thickness specifications.

Table 3 – KPS Land Pattern Design Recommendations (mm)

EIA SIZE CODE	METRIC SIZE CODE	Median (Nominal) Land Protrusion				
		C	Y	X	V1	V2
1210	3225	1.50	1.14	1.75	5.05	3.40
1812	4532	2.20	1.35	2.87	6.70	4.50
2220	5650	2.69	2.08	4.78	7.70	6.00

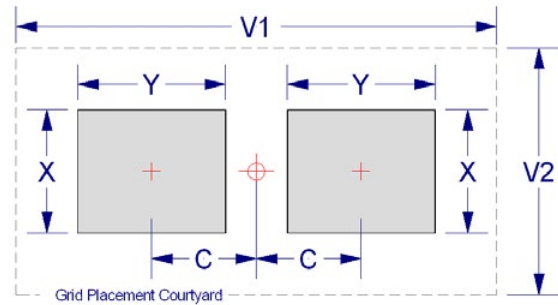

Soldering Process

KEMET's KPS Series devices are compatible with IR reflow techniques. Preheating of these components is recommended to avoid extreme thermal stress. KEMET's recommended profile conditions for IR reflow reflect the profile conditions of the IPC/J–STD–020D standard for moisture sensitivity testing.

To prevent degradation of temperature cycling capability, care must be taken to prevent solder from flowing into the inner side of the lead frames (inner side of "J" lead in contact with the circuit board).

After soldering, the capacitors should be air cooled to room temperature before further processing. Forced air cooling is not recommended.

Hand soldering should be performed with care due to the difficulty in process control. If performed, care should be taken to avoid contact of the soldering iron to the capacitor body. The iron should be used to heat the solder pad, applying solder between the pad and the lead, until reflow occurs. Once reflow occurs, the iron should be removed immediately. (Preheating is required when hand soldering to avoid thermal shock.)

Profile Feature	SnPb Assembly	Pb-Free Assembly
Preheat/Soak		
Temperature Minimum (T_{Smin})	100°C	150°C
Temperature Maximum (T_{Smax})	150°C	200°C
Time (t_s) from T_{Smin} to T_{Smax}	60 – 120 seconds	60 – 120 seconds
Ramp-up Rate (T_L to T_p)	3°C/seconds maximum	3°C/seconds maximum
Liquidous Temperature (T_L)	183°C	217°C
Time Above Liquidous (t_L)	60 – 150 seconds	60 – 150 seconds
Peak Temperature (T_p)	235°C	250°C
Time within 5°C of Maximum Peak Temperature (t_p)	20 seconds maximum	10 seconds maximum
Ramp-down Rate (T_p to T_L)	6°C/seconds maximum	6°C/seconds maximum
Time 25°C to Peak Temperature	6 minutes maximum	8 minutes maximum

Note: All temperatures refer to the center of the package, measured on the package body surface that is facing up during assembly reflow.

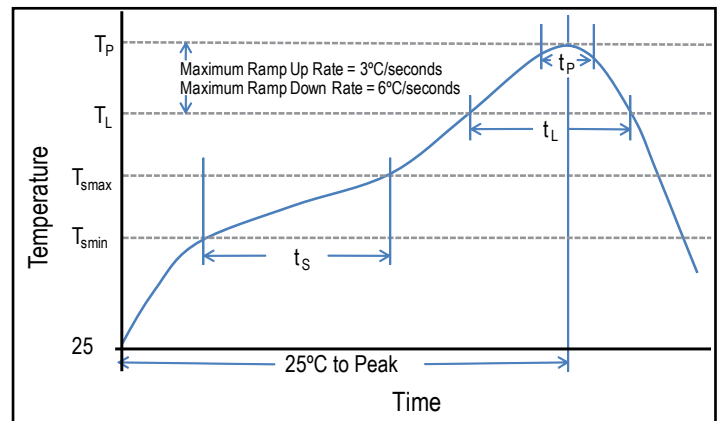

Table 4 – Performance & Reliability: Test Methods and Conditions

Stress	Reference	Test or Inspection Method
Terminal Strength	JIS-C-6429	Appendix 1, Note: Force of 1.8 kg for 60 seconds.
Board Flex	JIS-C-6429	Appendix 2, Note: 5.0 mm minimum
Solderability	J-STD-002	Magnification 50 X. Conditions:
		a) Method B, 4 hours @ 155°C, dry heat @ 235°C
		b) Method B @ 215°C category 3
		c) Method D, category 3 @ 250°C
Temperature Cycling	JESD22 Method JA-104	1,000 cycles (-55°C to +125°C). Measurement at 24 hours +/- 2 hours after test conclusion.
Biased Humidity	MIL-STD-202 Method 103	Load Humidity: 1,000 hours 85°C/85% RH and 200 VDC maximum. Add 100 K ohm resistor. Measurement at 24 hours +/- 2 hours after test conclusion.
		Low Volt Humidity: 1,000 hours 85°C/85% RH and 1.5 V. Add 100 K ohm resistor. Measurement at 24 hours +/- 2 hours after test conclusion.
Moisture Resistance	MIL-STD-202 Method 106	t = 24 hours/cycle. Steps 7a and 7b not required. Unpowered. Measurement at 24 hours +/- 2 hours after test conclusion.
Thermal Shock	MIL-STD-202 Method 107	-55°C/+125°C. Note: Number of cycles required – 300. Maximum transfer time – 20 seconds. Dwell time – 15 minutes. Air-Air.
High Temperature Life	MIL-STD-202 Method 108	1,000 hours at 125°C with rated voltage applied.
Storage Life	MIL-STD-202 Method 108	150°C, 0 VDC for 1,000 hours.
Vibration	MIL-STD-202 Method 204	5 g's for 20 minutes, 12 cycles each of 3 orientations. Note: Use 8" X 5" PCB .031" thick, 7 secure points on one long side and 2 secure points at corners of opposite sides. Parts mounted within 2" from any secure point. Test from 10 – 2,000 Hz.
Mechanical Shock	MIL-STD-202 Method 213	Figure 1 of Method 213, Condition F.
Resistance to Solvents	MIL-STD-202 Method 215	Add aqueous wash chemical, OKEM Clean or equivalent.

Storage & Handling

Ceramic chip capacitors should be stored in normal working environments. While the chips themselves are quite robust in other environments, solderability will be degraded by exposure to high temperatures, high humidity, corrosive atmospheres, and long term storage. In addition, packaging materials will be degraded by high temperature– reels may soften or warp and tape peel force may increase. KEMET recommends that maximum storage temperature not exceed 40°C and maximum storage humidity not exceed 70% relative humidity. Temperature fluctuations should be minimized to avoid condensation on the parts and atmospheres should be free of chlorine and sulfur bearing compounds. For optimized solderability chip stock should be used promptly, preferably within 1.5 years of receipt.

Construction

Reference	Item	Material
A	Leadframe	Phosphor Bronze – Alloy 510
B	Leadframe Attach	HMP Solder
C	Termination	Cu
D		Ni
E		Sn
F	Inner Electrode	Ni
G	Dielectric Material	BaTiO ₃

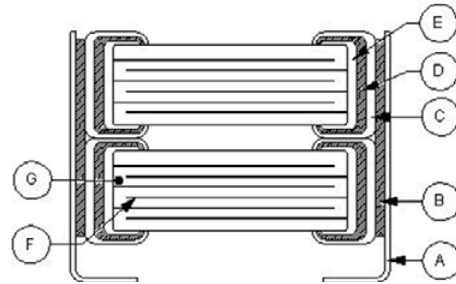

Note: Image is exaggerated in order to clearly identify all components of construction.
 HMP = High Melting Point

Product Marking

Laser marking option is not available on:

- COG, Ultra Stable X8R and Y5V dielectric devices
- EIA 0402 case size devices
- EIA 0603 case size devices with Flexible Termination option.
- KPS Commercial and Automotive grade stacked devices.

These capacitors are supplied unmarked only.

KPS Series, High Voltage, X7R Dielectric, 500 VDC – 630 VDC (Commercial Grade)

Overview

KEMET Power Solutions (KPS) High Voltage stacked capacitors utilize a proprietary lead-frame technology to vertically stack one or two multilayer ceramic chip capacitors into a single compact surface mount package. The attached lead-frame mechanically isolates the capacitor(s) from the printed circuit board, thereby offering advanced mechanical and thermal stress performance. Isolation also addresses concerns for audible microphonic noise that may occur when a bias voltage is applied. A two-chip stack offers up to double the capacitance in the same or smaller design footprint when compared to traditional surface mount MLCC devices. Providing up to 10 mm of board flex capability, KPS Series High Voltage capacitors are environmentally friendly and in compliance with RoHS legislation.

KEMET's KPS Series devices in X7R dielectric exhibit a

predictable change in capacitance with respect to time and voltage, and boast a minimal change in capacitance with reference to ambient temperature. Capacitance change is limited to $\pm 15\%$ from -55°C to $+125^{\circ}\text{C}$. These devices are capable of Pb-Free reflow profiles and provide lower ESR, ESL and higher ripple current capability when compared to other dielectric solutions.

Conventional uses include both snubbers and filters in applications such as switching power supplies and lighting ballasts. Their exceptional performance at high frequencies has made high voltage ceramic capacitors the preferred dielectric choice of design engineers worldwide. In addition to their use in power supplies, these capacitors are widely used in industries related to automotive (hybrid), telecommunications, medical, military, aerospace, semiconductors, and test/diagnostic equipment.

Benefits

- -55°C to $+125^{\circ}\text{C}$ operating temperature range
- Reliable and robust termination system
- EIA 2220 case size
- DC voltage ratings of 500 V and 630 V
- Capacitance offerings ranging from $0.047\ \mu\text{F}$ up to $1.0\ \mu\text{F}$
- Available capacitance tolerances of $\pm 10\%$ and $\pm 20\%$
- Higher capacitance in the same footprint
- Potential board space savings
- Advanced protection against thermal and mechanical stress
- Provides up to 10 mm of board flex capability
- Reduces audible microphonic noise
- Extremely low ESR and ESL
- Pb-Free and RoHS Compliant
- Capable of Pb-Free reflow profiles
- Non-polar device, minimizing installation concerns
- Film alternative



Ordering Information

C	2220	C	105	M	C	R	2	C	7186
Ceramic	Case Size (L"x W")	Specification/ Series	Capacitance Code (pF)	Capacitance Tolerance ¹	Rated Voltage (VDC)	Dielectric	Failure Rate/ Design	Leadframe Finish ²	Packaging/Grade (C-Spec) ³
	2220	C = Standard	2 significant digits + number of zeros.	K = $\pm 10\%$ M = $\pm 20\%$	C = 500 V B = 630 V	R = X7R	1 = KPS Single Chip Stack 2 = KPS Double Chip Stack	C = 100% Matte Sn	7186 = 7" Reel Unmarked 7289 = 13" Reel Unmarked

¹ Double chip stacks ("2" in the 13th character position of the ordering code) are only available in M ($\pm 20\%$) capacitance tolerance.

Single chip stacks ("1" in the 13th character position of the ordering code) are available in K ($\pm 10\%$) or M ($\pm 20\%$) tolerances.

² Additional leadframe finish options may be available. Contact KEMET for details.

³ Additional reeling or packaging options may be available. Contact KEMET for details.

Dimensions – Millimeters (Inches)

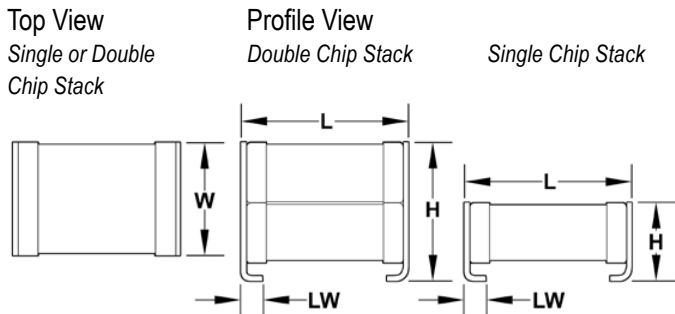

Number of Chips	EIA Size Code	Metric Size Code	L Length	W Width	H Height	LW Lead Width	Mounting Technique
Single	2220	5650	6.00 (0.236) ±0.50 (0.020)	5.00 (.197) ±0.50 (.020)	3.50 (.138) ±0.30 (.012)	1.60 (.063) ±0.30 (.012)	Solder Reflow Only
Double	2220	5650	6.00 (0.236) ±0.50 (0.020)	5.00 (.197) ±0.50 (.020)	5.00 (.197) ±0.50 (.020)	1.60 (.063) ±0.30 (.012)	

Applications

Typical applications include switch mode power supplies (input filters, resonators, tank circuits, snubber circuits, output filters), high voltage coupling and DC blocking, lighting ballasts, voltage multiplier circuits, DC/DC converters and coupling capacitors in Ćuk converters. Markets include power supply, LCD fluorescent backlight ballasts, HID lighting, telecom equipment, industrial and medical equipment/control, LAN/WAN interface, analog and digital modems, and automotive (electric and hybrid vehicles, charging stations and lighting applications).

Application Note

X7R dielectric is not recommended for AC line filtering or pulse applications.

Qualification/Certification

Commercial Grade products are subject to internal qualification. Details regarding test methods and conditions are referenced in Table 4 , Performance and Reliability.

Environmental Compliance

Pb-Free and RoHS Compliant.



RoHS Compliant

Electrical Parameters/Characteristics

Item	Parameters/Characteristics
Operating Temperature Range	-55°C to +125°C
Capacitance Change with Reference to +25°C and 0 VDC Applied (TCC)	±15%
Aging Rate (Maximum % Capacitance Loss/Decade Hour)	3.0%
Dielectric Withstanding Voltage (DWV)	150% of rated voltage for voltage rating of < 1,000 V 120% of rated voltage for voltage rating of ≥ 1,000 V (5 ±1 seconds and charge/discharge not exceeding 50 mA)
Dissipation Factor (DF) Maximum Limit @ 25°C	2.5%
Insulation Resistance (IR) Limit @ 25°C	See Insulation Resistance Limit Table (500 VDC applied for 120 ±5 seconds @ 25°C)

Regarding Aging Rate: Capacitance measurements (including tolerance) are indexed to a referee time of 1,000 hours.

To obtain IR limit, divide $M\Omega - \mu F$ value by the capacitance and compare to $G\Omega$ limit. Select the lower of the two limits.

Capacitance and Dissipation Factor (DF) measured under the following conditions:

1 kHz ±50 Hz and 1.0 ±0.2 Vrms if capacitance ≤ 10 μF

120 Hz ±10 Hz and 0.5 ±0.1 Vrms if capacitance >10 μF

Note: When measuring capacitance it is important to ensure the set voltage level is held constant. The HP4284 and Agilent E4980 have a feature known as Automatic Level Control (ALC). The ALC feature should be switched to "ON."

Post Environmental Limits

High Temperature Life, Biased Humidity, Moisture Resistance					
Dielectric	Rated DC Voltage	Capacitance Value	Dissipation Factor (Maximum %)	Capacitance Shift	Insulation Resistance
X7R	> 25	All	3.0	±20%	10% of Initial Limit
	16/25		5.0		
	< 16		7.5		

Insulation Resistance Limit Table

EIA Case Size	1,000 megohm microfarads or 100 GΩ	100 megohm microfarads or 10 GΩ
0805	< 0.0039 μF	≥ 0.0039 μF
1206	< 0.012 μF	≥ 0.012 μF
1210	< 0.033 μF	≥ 0.033 μF
1808	< 0.018 μF	≥ 0.018 μF
1812	< 0.027 μF	≥ 0.027 μF
≥ 1825	All	N/A

Table 1 – Capacitance Range/Selection Waterfall (2220 Case Sizes)

Capacitance	Capacitance Code	Case Size / Series		C2220C		
		Voltage Code		C	B	D
		Rated Voltage (VDC)		500	630	1000
		Capacitance Tolerance		Product Availability and Chip Thickness Codes – See Table 2 for Chip Thickness Dimensions		
Single Chip Stack						
0.047 μF	473	K	M	JP	JP	
0.10 μF	104	K	M	JP	JP	
0.15 μF	154	K	M	JP	JP	
0.22 μF	224	K	M	JP	JP	
0.33 μF	334	K	M	JP	JP	
0.47 μF	474	K	M	JP		
Double Chip Stack						
0.10 μF	104		M	JR	JR	
0.22 μF	224		M	JR	JR	
0.33 μF	334		M	JR	JR	
0.47 μF	474		M	JR	JR	
0.68 μF	664		M	JR		
1.0 μF	105		M	JR		
Capacitance	Capacitance Code	Rated Voltage (VDC)		500	630	1000
		Voltage Code		C	B	D
		Case Size / Series		C2220C		

Table 2 – Chip Thickness/Packaging Quantities

Thickness Code	Case Size	Thickness ± Range (mm)	Paper Quantity		Plastic Quantity	
			7" Reel	13" Reel	7" Reel	13" Reel
JP	2220	3.50 ± 0.30	0	0	300	1,300
JR	2220	5.00 ± 0.50	0	0	200	800

Package quantity based on finished chip thickness specifications.

Table 3 – KPS Land Pattern Design Recommendations (mm)

EIA SIZE CODE	METRIC SIZE CODE	Median (Nominal) Land Protrusion				
		C	Y	X	V1	V2
1210	3225	1.50	1.14	1.75	5.05	3.40
1812	4532	2.20	1.35	2.87	6.70	4.50
2220	5650	2.69	2.08	4.78	7.70	6.00

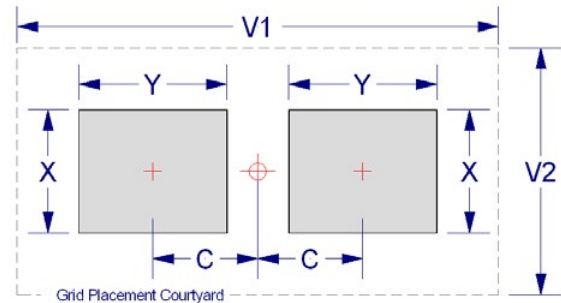

Soldering Process

KEMET's KPS Series devices are compatible with IR reflow techniques. Preheating of these components is recommended to avoid extreme thermal stress. KEMET's recommended profile conditions for IR reflow reflect the profile conditions of the IPC/J-STD-020D standard for moisture sensitivity testing.

To prevent degradation of temperature cycling capability, care must be taken to prevent solder from flowing into the inner side of the lead frames (inner side of "J" lead in contact with the circuit board).

After soldering, the capacitors should be air cooled to room temperature before further processing. Forced air cooling is not recommended.

Hand soldering should be performed with care due to the difficulty in process control. If performed, care should be taken to avoid contact of the soldering iron to the capacitor body. The iron should be used to heat the solder pad, applying solder between the pad and the lead, until reflow occurs. Once reflow occurs, the iron should be removed immediately. (Preheating is required when hand soldering to avoid thermal shock.)

Profile Feature	SnPb Assembly	Pb-Free Assembly
Preheat/Soak		
Temperature Minimum (T_{smin})	100°C	150°C
Temperature Maximum (T_{smax})	150°C	200°C
Time (t_s) from T_{smin} to T_{smax}	60 – 120 seconds	60 – 120 seconds
Ramp-up Rate (T_L to T_p)	3°C/seconds maximum	3°C/seconds maximum
Liquidous Temperature (T_L)	183°C	217°C
Time Above Liquidous (t_L)	60 – 150 seconds	60 – 150 seconds
Peak Temperature (T_p)	235°C	250°C
Time within 5°C of Maximum Peak Temperature (t_p)	20 seconds maximum	10 seconds maximum
Ramp-down Rate (T_p to T_L)	6°C/seconds maximum	6°C/seconds maximum
Time 25°C to Peak Temperature	6 minutes maximum	8 minutes maximum

Note: All temperatures refer to the center of the package, measured on the package body surface that is facing up during assembly reflow.

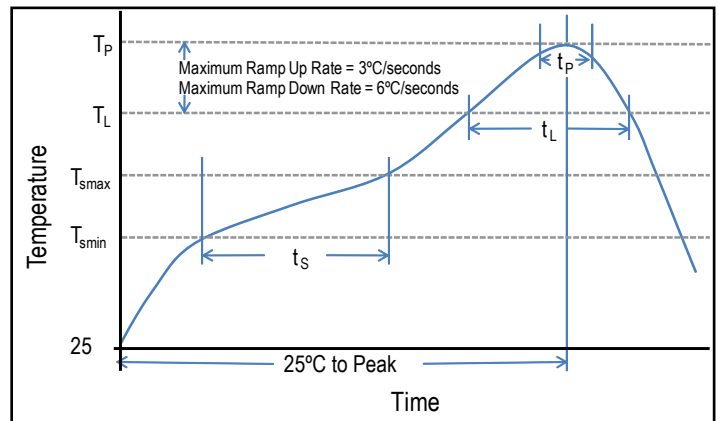

Table 4 – Performance & Reliability: Test Methods and Conditions

Stress	Reference	Test or Inspection Method
Terminal Strength	JIS-C-6429	Appendix 1, Note: Force of 1.8 kg for 60 seconds.
Board Flex	JIS-C-6429	Appendix 2, Note: 5.0 mm minimum
Solderability	J-STD-002	Magnification 50 X. Conditions:
		a) Method B, 4 hours @ 155°C, dry heat @ 235°C
		b) Method B @ 215°C category 3
		c) Method D, category 3 @ 250°C
Temperature Cycling	JESD22 Method JA-104	1,000 cycles (-55°C to +125°C). Measurement at 24 hours +/- 2 hours after test conclusion.
Biased Humidity	MIL-STD-202 Method 103	Load Humidity: 1,000 hours 85°C/85% RH and 200 VDC maximum. Add 100 K ohm resistor. Measurement at 24 hours +/- 2 hours after test conclusion.
		Low Volt Humidity: 1,000 hours 85°C/85% RH and 1.5 V. Add 100 K ohm resistor. Measurement at 24 hours +/- 2 hours after test conclusion.
Moisture Resistance	MIL-STD-202 Method 106	t = 24 hours/cycle. Steps 7a and 7b not required. Unpowered. Measurement at 24 hours +/- 2 hours after test conclusion.
Thermal Shock	MIL-STD-202 Method 107	-55°C/+125°C. Note: Number of cycles required – 300. Maximum transfer time – 20 seconds. Dwell time – 15 minutes. Air-Air.
High Temperature Life	MIL-STD-202 Method 108	1,000 hours at 125°C with rated voltage applied.
Storage Life	MIL-STD-202 Method 108	150°C, 0 VDC for 1,000 hours.
Vibration	MIL-STD-202 Method 204	5 g's for 20 minutes, 12 cycles each of 3 orientations. Note: Use 8" X 5" PCB 0.031" thick, 7 secure points on one long side and 2 secure points at corners of opposite sides. Parts mounted within 2" from any secure point. Test from 10 – 2,000 Hz.
Mechanical Shock	MIL-STD-202 Method 213	Figure 1 of Method 213, Condition F.
Resistance to Solvents	MIL-STD-202 Method 215	Add aqueous wash chemical, OKEM Clean or equivalent.

Storage and Handling

Ceramic chip capacitors should be stored in normal working environments. While the chips themselves are quite robust in other environments, solderability will be degraded by exposure to high temperatures, high humidity, corrosive atmospheres, and long term storage. In addition, packaging materials will be degraded by high temperature– reels may soften or warp and tape peel force may increase. KEMET recommends that maximum storage temperature not exceed 40°C and maximum storage humidity not exceed 70% relative humidity. Temperature fluctuations should be minimized to avoid condensation on the parts and atmospheres should be free of chlorine and sulfur bearing compounds. For optimized solderability chip stock should be used promptly, preferably within 1.5 years of receipt.

Construction

Reference	Item	Material
A	Leadframe	Phosphor Bronze – Alloy 510
B	Leadframe Attach	HMP Solder
C	Termination	Cu
D		Ni
E		Sn
F	Inner Electrode	Ni
G	Dielectric Material	BaTiO ₃

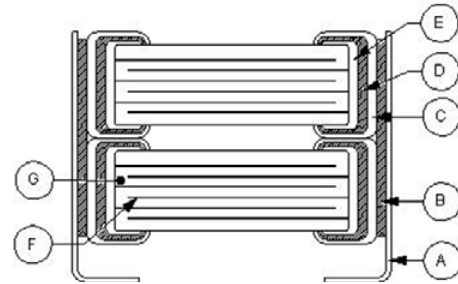

Note: Image is exaggerated in order to clearly identify all components of construction.
 HMP = High Melting Point

Product Marking

Laser marking option is not available on:

- COG, Ultra Stable X8R and Y5V dielectric devices
- EIA 0402 case size devices
- EIA 0603 case size devices with Flexible Termination option.
- KPS Commercial and Automotive grade stacked devices.

These capacitors are supplied unmarked only.

KPS HT Series, High Temperature 150°C, X8L Dielectric, 10 VDC – 50 VDC (Commercial & Automotive Grade)

Overview

KEMET Power Solutions High Temperature (KPS HT) stacked capacitors utilize a proprietary lead-frame technology to vertically stack one or two multilayer ceramic chip capacitors into a single compact surface mount package. The attached lead-frame mechanically isolates the capacitor(s) from the printed circuit board, thereby offering advanced mechanical and thermal stress performance. Isolation also addresses concerns for audible, microphonic noise that may occur when a bias voltage is applied. A two-chip stack offers up to double the capacitance in the same or smaller design footprint when compared to traditional surface mount MLCC devices. Providing up to 10 mm of board flex capability, KPS Series capacitors are environmentally friendly and in compliance with RoHS legislation. Combined with X8L dielectric, these devices are

capable of reliable operation up to 150°C and are well suited for high temperature filtering, bypass and decoupling applications.

X8L exhibits a predictable change in capacitance with respect to time and voltage, and boasts a minimal change in capacitance with reference to ambient temperature up to 125°C. Beyond 125°C, X8L displays a wider variation in capacitance. Capacitance change is limited to $\pm 15\%$ from -55°C to +125°C and +15, -40% from 125°C to 150°C.

In addition to Commercial grade, Automotive grade devices are available and meet the demanding Automotive Electronics Council's AEC-Q200 qualification requirements.

Benefits

- -55°C to +150°C operating temperature range
- Reliable and robust termination system
- EIA 1210 and 2220 case sizes
- DC voltage ratings of 10 V, 16 V, 25 V, and 50 V
- Capacitance offerings ranging from 0.47 μF up to 47 μF
- Available capacitance tolerances of $\pm 10\%$ and $\pm 20\%$
- Higher capacitance in the same footprint
- Potential board space savings
- Advanced protection against thermal and mechanical stress
- Provides up to 10 mm of board flex capability
- Reduces audible, microphonic noise
- Extremely low ESR and ESL
- Pb-Free and RoHS Compliant
- Capable of Pb-Free reflow profiles
- Non-polar device, minimizing installation concerns
- Tantalum and electrolytic alternative
- Commercial & Automotive (AEC-Q200) grades available



Ordering Information

C	2220	C	476	M	4	N	2	C	7186
Ceramic	Case Size (L"x W")	Specification/ Series	Capacitance Code (pF)	Capacitance Tolerance ¹	Rated Voltage (VDC)	Dielectric	Failure Rate/ Design	Leadframe Finish	Packaging/Grade (C-Spec)
	1210 2220	C = Standard	2 significant digits + number of zeros.	K = $\pm 10\%$ M = $\pm 20\%$	8 = 10 V 4 = 16 V 3 = 25 V 5 = 50 V	N = X8L	1 = KPS Single Chip Stack 2 = KPS Double Chip Stack	C = 100% Matte Sn	7186 = 7" Reel Unmarked 7289 = 13" Reel Unmarked AUTO = Automotive Grade 7" Reel Unmarked AUTO7289 = Automotive Grade 13" Reel Unmarked

¹ Double chip stacks ("2" in the 13th character position of the ordering code) are only available in M ($\pm 20\%$) capacitance tolerance.

Dimensions – Millimeters (Inches)

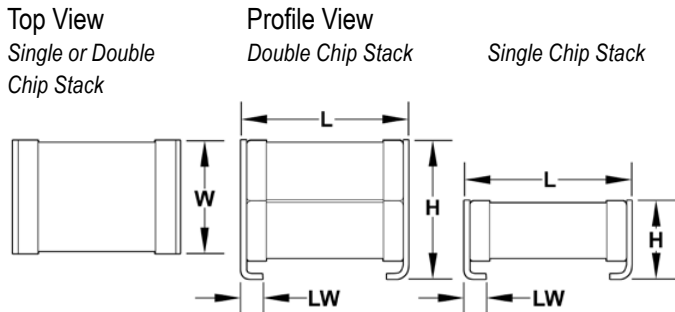

Chip Stack	EIA Size Code	Metric Size Code	L Length	W Width	H Height	LW Lead Width	Mounting Technique
Single	1210	3225	3.50 (.138) ±0.30 (.012)	2.60 (.102) ±0.30 (.012)	3.35 (.132) ±0.10 (.004)	0.80 (.032) ±0.15 (.006)	Solder Reflow Only
	2220	5650	6.00 (.236) ±0.50 (.020)	5.00 (.197) ±0.50 (.020)	3.50 (.138) ±0.30 (.012)	1.60 (.063) ±0.30 (.012)	
Double	1210	3225	3.50 (.138) ±0.30 (.012)	2.60 (.102) ±0.30 (.012)	6.15 (.242) ±0.15 (.006)	0.80 (.031) ±0.15 (.006)	
	2220	5650	6.00 (.236) ±0.50 (.020)	5.00 (.197) ±0.50 (.020)	5.00 (.197) ±0.50 (.020)	1.60 (.063) ±0.30 (.012)	

Applications

Typical applications include smoothing circuits, DC/DC converters, power supplies (input/output filters), noise reduction (piezoelectric/mechanical), circuits with a direct battery or power source connection, critical and safety relevant circuits without (integrated) current limitation and any application that is subject to extreme environments such as high temperature, high levels of board flexure and/or temperature cycling. Markets include industrial, aerospace, automotive, and telecom.

Qualification/Certification

Commercial Grade products are subject to internal qualification. Details regarding test methods and conditions are referenced in Table 4, Performance & Reliability.

Automotive Grade products meet or exceed the requirements outlined by the Automotive Electronics Council. Details regarding test methods and conditions are referenced in document AEC-Q200, Stress Test Qualification for Passive Components. For additional information regarding the Automotive Electronics Council and AEC-Q200, please visit their website at www.aecouncil.com.

Environmental Compliance

Pb-Free and RoHS Compliant.



RoHS Compliant

Electrical Parameters/Characteristics

Item	Parameters/Characteristics
Operating Temperature Range	-55°C to +150°C
Capacitance Change with Reference to +25°C and 0 VDC Applied (TCC)	±15% (-55°C to 125°C), +15, -40% (125°C to 150°C)
Aging Rate (Maximum % Capacitance Loss/Decade Hour)	3.0%
Dielectric Withstanding Voltage (DWV)	250% of rated voltage (5 ±1 seconds and charge/discharge not exceeding 50 mA)
Dissipation Factor (DF) Maximum Limit @ 25°C	3.5% (10 V and 16 V) and 2.5% (25 V and 50 V)
Insulation Resistance (IR) Limit @ 25°C	500 megohm microfarads or 10 GΩ (Rated voltage applied for 120 ±5 seconds @ 25°C)

Regarding Aging Rate: Capacitance measurements (including tolerance) are indexed to a referee time of 1,000 hours.

To obtain IR limit, divide MΩ - μF value by the capacitance and compare to GΩ limit. Select the lower of the two limits.

Capacitance and Dissipation Factor (DF) measured under the following conditions:

1 kHz ±50 Hz and 1.0 ±0.2 Vrms.

Note: When measuring capacitance it is important to ensure the set voltage level is held constant. The HP4284 and Agilent E4980 have a feature known as Automatic Level Control (ALC). The ALC feature should be switched to "ON."

Post Environmental Limits

High Temperature Life, Biased Humidity, Moisture Resistance					
Dielectric	Rated DC Voltage	Capacitance Value	Dissipation Factor (Maximum %)	Capacitance Shift	Insulation Resistance
X8L	> 25	All	3.0	±20%	10% of Initial Limit
	16 / 25		5.0		
	10		7.5		

Table 1 – Capacitance Range/Selection Waterfall (1210 – 2220 Case Sizes)

Capacitance	Cap Code	Case Size / Series			C1210C						C2220C					
		Voltage Code			8	4	3	5	1	A	8	4	3	5	1	A
		Rated Voltage (VDC)			10	16	25	50	100	250	10	16	25	50	100	250
		Capacitance Tolerance			Product Availability and Chip Thickness Codes – See Table 2 for Chip Thickness Dimensions											
Single Chip Stack																
0.47 µF	474		K	M	FV	FV	FV	FV								
1.0 µF	105		K	M	FV	FV	FV	FV								
2.2 µF	225		K	M	FV	FV	FV	FV				JP	JP	JP		
3.3 µF	335		K	M	FV	FV	FV	FV				JP	JP	JP		
4.7 µF	475		K	M	FV	FV	FV	FV				JP	JP	JP		
10 µF	106		K	M								JP	JP	JP		
15 µF	156		K	M								JP	JP	JP		
22 µF	226		K	M								JP	JP	JP		
Double Chip Stack																
1.0 µF	105			M	FW	FW	FW	FW								
2.2 µF	225			M	FW	FW	FW	FW								
3.3 µF	335			M	FW	FW	FW	FW								
4.7 µF	475			M	FW	FW	FW	FW				JR	JR	JR		
10 µF	106			M	FW	FW	FW	FW				JR	JR	JR		
22 µF	226			M								JR	JR	JR		
33 µF	336			M								JR	JR	JR		
47 µF	476			M								JR	JR	JR		
Capacitance	Cap Code	Rated Voltage (VDC)			10	16	25	50	100	250	10	16	25	50	100	250
		Voltage Code			8	4	3	5	1	A	8	4	3	5	1	A
		Case Size / Series			C1210C						C2220C					

These products are protected under US Patent 8,331,078 other patents pending, and any foreign counterparts.

Table 2 – Chip Thickness/Packaging Quantities

Thickness Code	Case Size	Thickness ± Range (mm)	Paper Quantity		Plastic Quantity	
			7" Reel	13" Reel	7" Reel	13" Reel
FV	1210	3.35 ± 0.10	0	0	600	2,000
FW	1210	6.15 ± 0.15	0	0	300	1,000
JP	2220	3.50 ± 0.30	0	0	300	1,300
JR	2220	5.00 ± 0.50	0	0	200	800

Package quantity based on finished chip thickness specifications.

Table 3 – KPS Land Pattern Design Recommendations (mm)

EIA SIZE CODE	METRIC SIZE CODE	Median (Nominal) Land Protrusion				
		C	Y	X	V1	V2
1210	3225	1.50	1.14	1.75	5.05	3.40
2220	5650	2.69	2.08	4.78	7.70	6.00

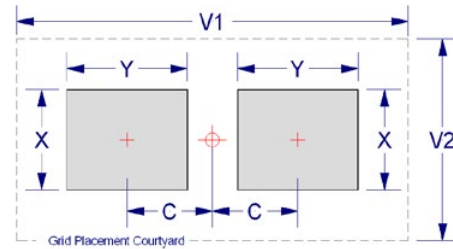

Soldering Process

KEMET's KPS Series devices are compatible with IR reflow techniques. Preheating of these components is recommended to avoid extreme thermal stress. KEMET's recommended profile conditions for IR reflow reflect the profile conditions of the IPC/J-STD-020D standard for moisture sensitivity testing.

To prevent degradation of temperature cycling capability, care must be taken to prevent solder from flowing into the inner side of the lead frames (inner side of "J" lead in contact with the circuit board).

After soldering, the capacitors should be air cooled to room temperature before further processing. Forced air cooling is not recommended.

Hand soldering should be performed with care due to the difficulty in process control. If performed, care should be taken to avoid contact of the soldering iron to the capacitor body. The iron should be used to heat the solder pad, applying solder between the pad and the lead, until reflow occurs. Once reflow occurs, the iron should be removed immediately. (Preheating is required when hand soldering to avoid thermal shock.)

Profile Feature	SnPb Assembly	Pb-Free Assembly
Preheat/Soak		
Temperature Minimum (T_{smin})	100°C	150°C
Temperature Maximum (T_{smax})	150°C	200°C
Time (t_s) from T_{smin} to T_{smax}	60 – 120 seconds	60 – 120 seconds
Ramp-up Rate (T_L to T_p)	3°C/seconds maximum	3°C/seconds maximum
Liquidous Temperature (T_L)	183°C	217°C
Time Above Liquidous (t_L)	60 – 150 seconds	60 – 150 seconds
Peak Temperature (T_p)	235°C	250°C
Time within 5°C of Maximum Peak Temperature (t_p)	20 seconds maximum	10 seconds maximum
Ramp-down Rate (T_p to T_L)	6°C/seconds maximum	6°C/seconds maximum
Time 25°C to Peak Temperature	6 minutes maximum	8 minutes maximum

Note: All temperatures refer to the center of the package, measured on the package body surface that is facing up during assembly reflow.

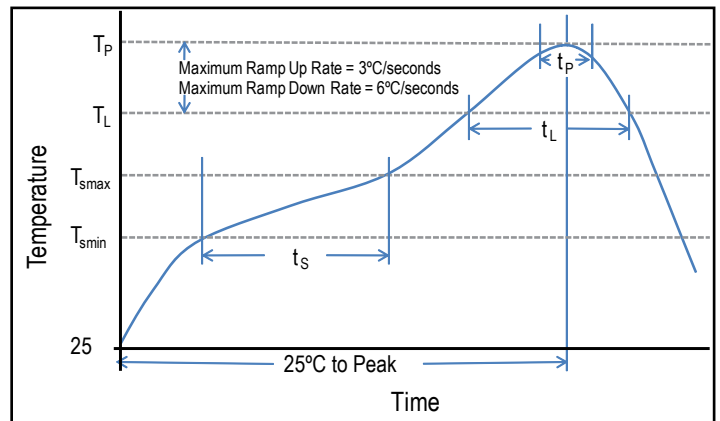

Table 4 – Performance & Reliability: Test Methods and Conditions

Stress	Reference	Test or Inspection Method
Terminal Strength	JIS-C-6429	Appendix 1, Note: Force of 1.8 kg for 60 seconds.
Board Flex	JIS-C-6429	Appendix 2, Note: 5.0 mm minimum
Solderability	J-STD-002	Magnification 50 X. Conditions:
		a) Method B, 4 hours @ 155°C, dry heat @ 235°C
		b) Method B @ 215°C category 3
		c) Method D, category 3 @ 250°C
Temperature Cycling	JESD22 Method JA-104	1,000 cycles (-55°C to +150°C). Measurement at 24 hours +/- 2 hours after test conclusion.
Biased Humidity	MIL-STD-202 Method 103	Load Humidity: 1,000 hours 85°C/85% RH and rated voltage. Add 100 K ohm resistor. Measurement at 24 hours +/- 2 hours after test conclusion.
		Low Volt Humidity: 1,000 hours 85°C/85% RH and 1.5 V. Add 100 K ohm resistor. Measurement at 24 hours +/- 2 hours after test conclusion.
Moisture Resistance	MIL-STD-202 Method 106	t = 24 hours/cycle. Steps 7a and 7b not required. Unpowered. Measurement at 24 hours +/- 2 hours after test conclusion.
Thermal Shock	MIL-STD-202 Method 107	-55°C/+150°C. Note: Number of cycles required- 300, maximum transfer time- 20 seconds, Dwell time- 15 minutes. Air-Air.
High Temperature Life	MIL-STD-202 Method 108	1,000 hours at 150°C with rated voltage applied.
Storage Life	MIL-STD-202 Method 108	150°C, 0 VDC for 1,000 hours.
Vibration	MIL-STD-202 Method 204	5 g's for 20 minutes, 12 cycles each of 3 orientations. Note: Use 8" X 5" PCB .031" thick, 7 secure points on one long side and 2 secure points at corners of opposite sides. Parts mounted within 2" from any secure point. Test from 10 – 2,000 Hz.
Mechanical Shock	MIL-STD-202 Method 213	Figure 1 of Method 213, Condition F.
Resistance to Solvents	MIL-STD-202 Method 215	Add aqueous wash chemical, OKEM Clean or equivalent.

Storage & Handling

Ceramic chip capacitors should be stored in normal working environments. While the chips themselves are quite robust in other environments, solderability will be degraded by exposure to high temperatures, high humidity, corrosive atmospheres, and long term storage. In addition, packaging materials will be degraded by high temperature– reels may soften or warp and tape peel force may increase. KEMET recommends that maximum storage temperature not exceed 40°C and maximum storage humidity not exceed 70% relative humidity. Temperature fluctuations should be minimized to avoid condensation on the parts and atmospheres should be free of chlorine and sulfur bearing compounds. For optimized solderability chip stock should be used promptly, preferably within 1.5 years of receipt.

Construction

Reference	Item	Material
A	Leadframe	Phosphor Bronze – Alloy 510
B	Leadframe Attach	HMP Solder
C	Termination	Cu
D		Ni
E		Sn
F	Inner Electrode	Ni
G	Dielectric Material	BaTiO ₃

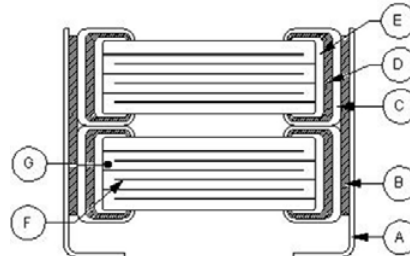

*Note: Image is exaggerated in order to clearly identify all components of construction.
 HMP = High Melting Point*

Product Marking

Laser marking option is not available on:

- COG, Ultra Stable X8R and Y5V dielectric devices
- EIA 0402 case size devices
- EIA 0603 case size devices with Flexible Termination option.
- KPS Commercial and Automotive grade stacked devices.

These capacitors are supplied unmarked only.

KPS MIL Series, SMPS Stacked Capacitors, MIL-PRF-49470, DSCC 87106, 50 – 500 VDC (Commercial, Military, & Space Grades)

KEMET
 CHARGED®

Overview

KEMET Power Solutions (KPS) MIL Series ceramic stacked capacitors are available in commercial, military and space grades and are well suited for standard and high reliability switch mode power supply (SMPS) and pulse energy applications. Qualified under performance specification MIL-PRF-49470, our military and space grade products meet or exceed the requirements outlined by DSCC (Defense Supply Center, Columbus) and are available in both B (standard reliability) & T (high reliability) product levels. MIL-PRF-49470 was developed as part of a cooperative effort between the U.S. Military, NASA and SMPS suppliers to produce a robust replacement to cancelled DSCC Drawing 87106.

The KPS MIL Series is constructed using large chip multilayer ceramic capacitors (MLCCs), horizontally stacked and secured to a lead-frame termination system using a high melting point (HMP) solder alloy. The lead frame isolates the MLCCs from the

printed circuit board (PCB) while establishing a parallel circuit configuration. Mechanically isolating the capacitors from the PCB improves mechanical and thermal stress performance, while the parallel circuit configuration allows for bulk capacitance in the same or smaller design footprint.

Available in BX, BR, BQ, and X7R dielectrics, these devices are available in encapsulated and unencapsulated styles in both surface mountable and through-hole configurations. Their low Equivalent Series Resistance (ESR) and Equivalent Series Inductance (ESL) make them ideally suited for input and output filtering of power supply as well as snubber applications. The encapsulated styles are primarily used where increased mechanical and environmental protection is required, such as in avionics systems.

Benefits

- -55°C to +125°C operating temperature range
- High frequency performance
- Bulk capacitance in a reduced footprint
- MIL-PRF-49470 QPL
- Military Case Codes 3, 4 and 5
- Space Grade available ("T" Level)
- DSCC approved (87106)
- Commercial/Industrial Grade available
- Customer specific requirements available
- Low ESR and ESL
- High thermal stability
- High ripple current capability
- Higher reliability than aluminum electrolytic or tantalum
- Available encapsulated or unencapsulated

Applications

- Military
- Space
- Industrial
- Input and output filtering on power supplies – often found on "capacitor banks"
- Snubber circuits
- Radar filtering (28 V/microwave burst)

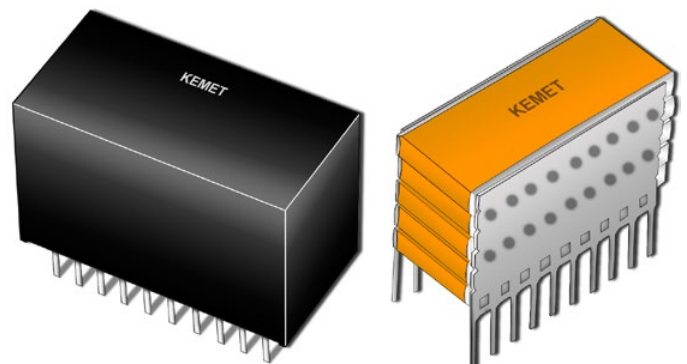

MIL-PRF-49470 Ordering Information

M49470	R	01	474	K	C	N
Performance Specification Indicating MIL-PRF-49470 ¹	Dielectric Classification/ Characteristic ²	Performance Specification Sheet Number (Indicating MIL-PRF-49470/1) ³	Capacitance Code (pF)	Capacitance Tolerance	Rated Voltage (VDC)	Lead Configuration ⁴
M49470 = B level T49470 = T level A "T" prefix is used in place of the "M" for T level product.	Q = BQ R = BR X = BX	01 = Unencapsulated 02 = Encapsulated	2 Significant Digits + Number of Zeros	J = ±5% K = ±10% M = ±20%	A = 50 B = 100 C = 200 E = 500	N = Straight Pin L = Formed "L" M = Formed "L" J = Formed "J" K = Formed "J"

¹ Indicates performance and reliability requirements. "B" level represents standard reliability. "T" level represents high reliability.

¹ Please refer to performance specification sheet MIL-PRF-49470 for details regarding test levels. The latest revision of the specification sheet is available through DSCC.

^{1,3} Test level option "T" is not available on encapsulated stacked devices (i.e. MIL-PRF-49470/2).

² Dielectric classification and characteristic details are outlined in the "Electrical Parameters" section of this document.

⁴ Lead configuration and dimension details are outlined in the "Dimensions" section of this document.

KPS MIL Series, SMPS Stacks Ordering Information

(Do not use this ordering code if a QPL MIL-SPEC part type is required. Please order using MIL-SPEC ordering code. Details regarding MIL-PRF-49470 QPL ordering information is outlined above.)

L1	R	N	30	C	106	K	S	12	
Product Family ¹	Dielectric Classification/ Characteristic ²	Lead Configuration ³	Case Size / Case Code (CC)	Rated Voltage (VDC)	Capacitance Code (pF)	Capacitance Tolerance	Testing Option ⁴	Maximum Height Dimension (in.) ⁵	
L1 = Unencapsulated L2 = Encapsulated	Q = BQ R = BR X = BX W = X7R	N = Straight L = Formed "L" M = Formed "L" J = Formed "J" K = Formed "J"	30 = CC 3 40 = CC 4 50 = CC 5	3 = 25 5 = 50 1 = 100 2 = 200 C = 500 B = 630 D = 1,000	2 Significant Digits + Number of Zeros	J = ±5% K = ±10% M = ±20%	B = M49470 "B" Level T = M49470 "T" Level C = DSCC87106 S = Commercial X = Non-Standard (Customer Specific Requirements)	Unencapsulated 12 = 0.12" 24 = 0.24" 36 = 0.36" 48 = 0.48" 65 = 0.65"	Encapsulated 27 = 0.27" 39 = 0.39" 53 = 0.53" 66 = 0.66" 80 = 0.80"

^{1,4} Test level option "T" is not available on encapsulated stacked devices, i.e., MIL-PRF-49470/2. If a QPL MIL-Spec part type is required, please order using the MIL-Spec ordering code.

² Dielectric classification and characteristic details are outlined in the "Electrical Parameters" section of this document.

³ Lead configuration and dimension details are outlined in the "Dimensions" section of this document. Additional lead configurations may be available. Contact KEMET for details.

⁴ Indicates performance and reliability requirements. Testing option details are outlined in the "Performance & Reliability" section of this document.

⁴ Please refer to performance specification sheet MIL-PRF-49470 for additional details regarding test levels. The latest revision of the specification sheet is available through DSCC.

⁴ DSCC Drawing 87106 was cancelled on 01/03/2005. MIL-PRF-49470 capacitors are preferred over DSCC Drawing 87106 capacitors.

⁵ Maximum height dimensions are provided in product tables 1A, 1B, and 1C of this document

Ordering Information Requirements per DSCC Drawing 87106

DSCC Drawing 87106 was cancelled on 01/03/2005. Customers can continue to order per 87106 requirements using the original DSCC ordering code, i.e., 87106-001. When available, MIL-PRF-49470 devices are preferred over DSCC Drawing 87106. The MIL-PRF-49470 military specification product provides additional quality assurance provisions that are not required by the DSCC drawing. These extra provisions create a more robust replacement.

Construction

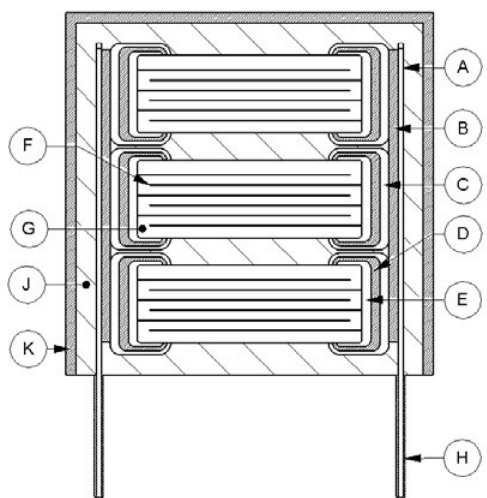

Note: Image is exaggerated in order to clearly identify all components of construction

Reference	Item	Material	
A	Leadframe	Phosphor Bronze – Alloy 510	
B	Leadframe Attach Solder	Sn10, Pb88, Ag2	
C	Termination System ¹	SnPb (4% minimum)	Solderable Silver
D		Ni	
E		Ag	
F	Electrode	PdAg	
G	Dielectric	BaTiO ³	
H	Lead Solder	Sn60, Pb40	
J	Encapsulation ²	Molding Compound	
K		Diallyl-Phthalate (DAP)	

¹ KEMET reserves the right to construct these devices using either of the termination systems outlined.

² Encapsulated product only, i.e., MIL-PRF-49470/2 and L2 product families.

Unencapsulated (M49470/1 & L1) Product Dimensions – Inches (Millimeters)

Case Code	C Lead Spacing ±0.025 (0.635)	E Length ±0.010 (0.250)	D Width Minimum	D Width Maximum	A Height Maximum	Seating Plane ¹ ±0.010 (0.250)	Number of Leads per Side	Mounting Technique
3	0.450 (11.43)	0.500 (12.70)	0.950 (24.13)	1.075 (27.30)	Refer to tables 1A & 1C for specific maximum A dimension	0.055 (1.40)	10	Solder reflow only
4	0.400 (10.16)	0.440 (11.18)	0.350 (8.89)	0.425 (10.80)			4	
5	0.250 (6.35)	0.300 (7.62)	0.224 (5.69)	0.275 (6.98)			3	

¹ Only applies to lead style "N" (straight).

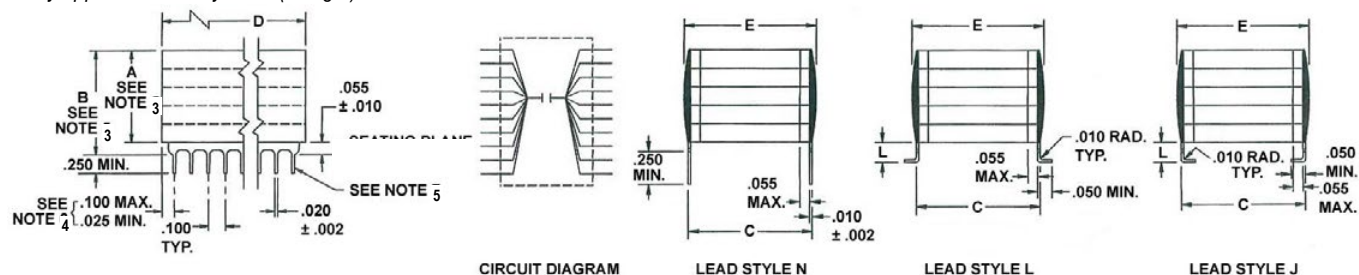

1. Unless otherwise specified, tolerances are ±0.010" (0.25 mm).
2. Metric equivalents for C, D and E dimensions are provided for general information only.
3. For maximum B dimension, add 0.065" (1.65 mm) to the appropriate A dimension. For all lead styles, the number of chips is determined by the capacitance and voltage rating.
4. For case code 5, dimensions shall be 0.100" (2.54 mm) maximum and 0.012" (0.30 mm) minimum.
5. Lead alignment within pin rows shall be within ±0.005" (0.13 mm).

Unencapsulated & Encapsulated Lead Configurations – Inches (Millimeters)

Lead Style Symbol	Lead Style	L Lead Length
N	(N) Straight	0.250 Min. (6.35)
L	(L) Formed	0.070 ± 0.010 (1.78 ± 0.25)
M		0.045 ± 0.010 (1.14 ± 0.25)
J	(J) Formed	0.070 ± 0.010 (1.78 ± 0.25)
K		0.045 ± 0.010 (1.14 ± 0.25)

Additional lead configurations may be available. Contact KEMET for details.

Encapsulated (M49470/2 & L2) Product Dimensions – Inches (Millimeters)

Case Code	C Lead Spacing ±0.025 (0.635)	E Length Maximum	D Width ±0.635 (±0.025)	A Height	Number of Leads per Side	Mounting Technique
3	0.450 (11.43)	0.580 (14.73)	1.155 (29.34)	Refer to table 1B for specific maximum A dimension	10	Solder reflow only
4	0.400 (10.16)	0.485 (12.32)	0.485 (12.32)		4	
5	0.250 (6.35)	0.355 (9.02)	0.355 (9.02)		3	

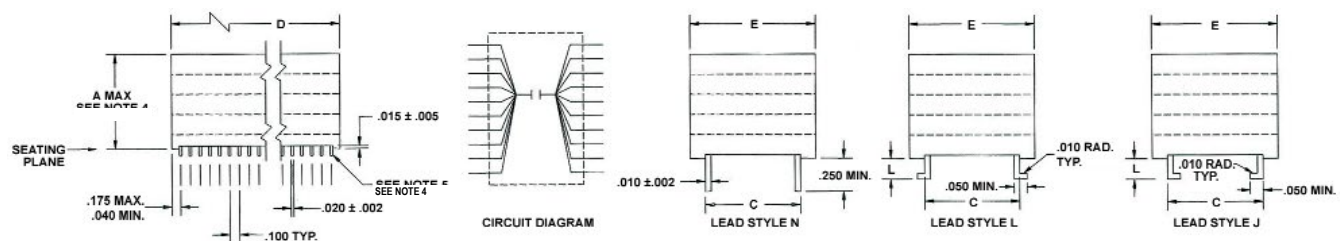

1. Dimensions are in inches.
2. Metric equivalents are given for general information only.
3. Unless otherwise specified, tolerances are ±0.010" (0.25 mm).
4. Lead alignment within pin rows shall be within ±0.005" (0.13 mm).

Unencapsulated & Encapsulated Lead Configurations – Inches (Millimeters)

Lead Style Symbol	Lead Style	L Lead Length
N	(N) Straight	0.250 Min. (6.35)
L	(L) Formed	0.070 ± 0.010 (1.78 ± 0.25)
M		0.045 ± 0.010 (1.14 ± 0.25)
J	(J) Formed	0.070 ± 0.010 (1.78 ± 0.25)
K		0.045 ± 0.010 (1.14 ± 0.25)

Additional lead configurations may be available. Contact KEMET for details.

Qualification Inspection Per MIL-PRF-49470

Inspection	Test Method Paragraph
Group I	
Thermal shock and voltage conditioning	4.8.5
Group II	
Visual and mechanical Inspection	4.8.4
Group III	
Low temperature storage	4.8.23
Barometric pressure	4.8.9
Terminal strength	4.8.10
Group IV	
Voltage-temperature limits	4.8.13.1
Vibration, high frequency	4.8.14
Immersion	4.8.15
Group V	
Shock, specified pulse	4.8.16
Resistance to soldering heat	4.8.17
Moisture resistance	4.8.18
Group VI	
DPA (T level only)	4.8.19
Group VII	
Humidity, steady state, low voltage (T level only)	4.8.21
Group VIII	
Life	4.8.22

Environmental Compliance

These devices do not meet RoHS criteria

Electrical Parameters/Performance Characteristics: BQ Dielectric

Item	Parameters/Characteristics
Operating Temperature Range	-55°C to +125°C
Capacitance Change with Reference to +25°C and 0 VDC Applied (TCC)	±15%
Capacitance Change with Reference to +25°C and 100% Rated VDC Applied	+15%, -50%
Aging Rate (Maximum % Capacitance Loss/Decade Hour)	1%
Dielectric Withstanding Voltage (DWV)	250% of rated DC voltage for voltage rating < 500 V 150% of rated DC voltage for voltage rating of 500 V (5 ±1 seconds and charge/discharge not exceeding 50 mA)
Dissipation Factor (DF) Maximum Limit @ 25°C	2.5%
Insulation Resistance (IR) Limit @ 25°C	1,000 megohm microfarads (minimum) or 100 GΩ
Insulation Resistance (IR) Limit @ 125°C	100 megohm microfarads (minimum) or 10 GΩ

Regarding aging rate: Capacitance measurements (including tolerance) are indexed to a referee time of 1,000 hours.

To obtain IR limit, divide MΩ-μF value by the capacitance and compare to GΩ limit. Select the lower of the two limits.

Capacitance and dissipation factor (DF) measured under the following conditions:

1 kHz ±100 Hz at 1.0 Vrms ±0.2 Vrms (open circuit voltage).

Note: When measuring capacitance it is important to ensure the set voltage level is held constant. The HP4284 and Agilent E4980 have a feature known as Automatic Level Control (ALC). The ALC feature should be switched to "ON."

Electrical Parameters/Performance Characteristics: BR Dielectric

Item	Parameters/Characteristics
Operating Temperature Range	-55°C to +125°C
Capacitance Change with Reference to +25°C and 0 VDC Applied (TCC)	±15%
Capacitance Change with Reference to +25°C and 100% Rated VDC Applied	+15%, -40%
Aging Rate (Maximum % Capacitance Loss/Decade Hour)	1%
Dielectric Withstanding Voltage (DWV)	250% of rated DC voltage for voltage rating < 500 V 150% of rated DC voltage for voltage rating of 500 V (5 ±1 seconds and charge/discharge not exceeding 50 mA)
Dissipation Factor (DF) Maximum Limit @ 25°C	2.5%
Insulation Resistance (IR) Limit @ 25°C	1,000 megohm microfarads (minimum) or 100 GΩ
Insulation Resistance (IR) Limit @ 125°C	100 megohm microfarads (minimum) or 10 GΩ

Regarding aging rate: Capacitance measurements (including tolerance) are indexed to a referee time of 1,000 hours.

To obtain IR limit, divide MΩ-μF value by the capacitance and compare to GΩ limit. Select the lower of the two limits.

Capacitance and dissipation factor (DF) measured under the following conditions:

1 kHz ±100 Hz at 1.0 Vrms ±0.2 Vrms (open circuit voltage).

Note: When measuring capacitance it is important to ensure the set voltage level is held constant. The HP4284 and Agilent E4980 have a feature known as Automatic Level Control (ALC). The ALC feature should be switched to "ON."

Electrical Parameters/Performance Characteristics: BX Dielectric

Item	Parameters/Characteristics
Operating Temperature Range	-55°C to +125°C
Capacitance Change with Reference to +25°C and 0 VDC Applied (TCC)	±15%
Capacitance Change with Reference to +25°C and 100% Rated VDC Applied	+15%, -25%
Aging Rate (Maximum % Capacitance Loss/Decade Hour)	1%
Dielectric Withstanding Voltage (DWV)	250% of rated DC voltage for voltage rating < 500 V 150% of rated DC voltage for voltage rating of 500 V (5 ±1 seconds and charge/discharge not exceeding 50 mA)
Dissipation Factor (DF) Maximum Limit @ 25°C	2.5%
Insulation Resistance (IR) Limit @ 25°C	1000 megohm microfarads (minimum) or 100 GΩ
Insulation Resistance (IR) Limit @ 125°C	100 megohm microfarads (minimum) or 10 GΩ

Regarding aging rate: Capacitance measurements (including tolerance) are indexed to a referee time of 1000 hours.

To obtain IR limit, divide $M\Omega\text{-}\mu F$ value by the capacitance and compare to $G\Omega$ limit. Select the lower of the two limits.

Capacitance and dissipation factor (DF) measured under the following conditions:

1 kHz ±100 Hz at 1.0 Vrms ±0.2 Vrms (open circuit voltage).

Note: When measuring capacitance it is important to ensure the set voltage level is held constant. The HP4284 and Agilent E4980 have a feature known as Automatic Level Control (ALC). The ALC feature should be switched to "ON."

Electrical Parameters/Performance Characteristics: X7R Dielectric

Item	Parameters/Characteristics
Operating Temperature Range	-55°C to +125°C
Capacitance Change with Reference to +25°C and 0 VDC Applied (TCC)	±15%
Aging Rate (Maximum % Capacitance Loss/Decade Hour)	3.0%
Dielectric Withstanding Voltage (DWV)	250% of rated voltage (5 ±1 seconds and charge/discharge not exceeding 50 mA)
Dissipation Factor (DF) Maximum Limit @ 25°C	3.5% (25 V) and 2.5% (50 V to 200 V)
Insulation Resistance (IR) Limit @ 25°C	1,000 megohm microfarads or 100 GΩ (Rated voltage applied for 120 ±5 seconds @ 25°C)

Regarding aging rate: Capacitance measurements (including tolerance) are indexed to a referee time of 1000 hours.

To obtain IR limit, divide $M\Omega\text{-}\mu F$ value by the capacitance and compare to $G\Omega$ limit. Select the lower of the two limits.

Capacitance and dissipation factor (DF) measured under the following conditions:

1 kHz ±50 Hz and 1.0 ±0.2 Vrms if capacitance ≤ 10 μF.

20 Hz ±10 Hz and 0.5 ±0.1 Vrms if capacitance > 10 μF.

Note: When measuring capacitance it is important to ensure the set voltage level is held constant. The HP4284 and Agilent E4980 have a feature known as Automatic Level Control (ALC). The ALC feature should be switched to "ON."

Table 1A – MIL-PRF-49470/1, Product Selection 50 – 200 VDC

MIL-PRF-49470/1 Unencapsulated, Horizontally Stacked						
MIL-PRF-49470 P/N ¹	Capacitance (μF)	Case Code	Height A inch (mm)	Capacitance Tolerance	Lead Configuration	KEMET P/N ¹
50 VDC – BX Dielectric						
(1)49470X01105(2)A(3)	1	5	0.120 (3.05)	K, M	N, L, M, J, K	L1X(3)505105(2)(4)12
(1)49470X01125(2)A(3)	1.2	5	0.120 (3.05)	K, M	N, L, M, J, K	L1X(3)505125(2)(4)12
(1)49470X01155(2)A(3)	1.5	5	0.240 (6.10)	K, M	N, L, M, J, K	L1X(3)505155(2)(4)24
(1)49470X01185(2)A(3)	1.8	5	0.240 (6.10)	K, M	N, L, M, J, K	L1X(3)505185(2)(4)24
(1)49470X01225(2)A(3)	2.2	5	0.240 (6.10)	K, M	N, L, M, J, K	L1X(3)505225(2)(4)24
(1)49470X01275(2)A(3)	2.7	5	0.360 (9.14)	K, M	N, L, M, J, K	L1X(3)505275(2)(4)36
(1)49470X01335(2)A(3)	3.3	5	0.360 (9.14)	K, M	N, L, M, J, K	L1X(3)505335(2)(4)36
(1)49470X01475(2)A(3)	3.9	5	0.480 (12.19)	K, M	N, L, M, J, K	L1X(3)505475(2)(4)48
(1)49470X01395(2)A(3)	3.9	5	0.480 (12.19)	K, M	N, L, M, J, K	L1X(3)505395(2)(4)48
(1)49470X01565(2)A(3)	5.6	5	0.650 (16.51)	K, M	N, L, M, J, K	L1X(3)505565(2)(4)65
(1)49470X01685(2)A(3)	6.8	4	0.360 (9.14)	K, M	N, L, M, J, K	L1X(3)405685(2)(4)36
(1)49470X01825(2)A(3)	8.2	4	0.360 (9.14)	K, M	N, L, M, J, K	L1X(3)405825(2)(4)36
(1)49470X01106(2)A(3)	10	4	0.480 (12.19)	K, M	N, L, M, J, K	L1X(3)405106(2)(4)48
(1)49470X01126(2)A(3)	12	4	0.480 (12.19)	K, M	N, L, M, J, K	L1X(3)405126(2)(4)48
(1)49470X01156(2)A(3)	15	4	0.650 (16.51)	K, M	N, L, M, J, K	L1X(3)405156(2)(4)65
(1)49470X01186(2)A(3)	18	3	0.240 (6.10)	K, M	N, L, M, J, K	L1X(3)305186(2)(4)24
(1)49470X01226(2)A(3)	22	3	0.360 (9.14)	K, M	N, L, M, J, K	L1X(3)305226(2)(4)36
(1)49470X01276(2)A(3)	27	3	0.360 (9.14)	K, M	N, L, M, J, K	L1X(3)305276(2)(4)36
(1)49470X01336(2)A(3)	33	3	0.360 (9.14)	K, M	N, L, M, J, K	L1X(3)305336(2)(4)36
(1)49470X01396(2)A(3)	39	3	0.480 (12.19)	K, M	N, L, M, J, K	L1X(3)305396(2)(4)48
(1)49470X01476(2)A(3)	47	3	0.650 (16.51)	K, M	N, L, M, J, K	L1X(3)305476(2)(4)65
100 VDC – BX Dielectric						
(1)49470X01684(2)B(3)	0.68	5	0.120 (3.05)	K, M	N, L, M, J, K	L1X(3)501684(2)(4)12
(1)49470X01824(2)B(3)	0.82	5	0.240 (6.10)	K, M	N, L, M, J, K	L1X(3)501824(2)(4)24
(1)49470X01105(2)B(3)	1	5	0.240 (6.10)	K, M	N, L, M, J, K	L1X(3)501105(2)(4)24
(1)49470X01125(2)B(3)	1.2	5	0.240 (6.10)	K, M	N, L, M, J, K	L1X(3)501125(2)(4)24
(1)49470X01155(2)B(3)	1.5	5	0.360 (9.14)	K, M	N, L, M, J, K	L1X(3)501155(2)(4)36
(1)49470X01185(2)B(3)	1.8	5	0.360 (9.14)	K, M	N, L, M, J, K	L1X(3)501185(2)(4)36
(1)49470X01225(2)B(3)	2.2	5	0.480 (12.19)	K, M	N, L, M, J, K	L1X(3)501225(2)(4)48
(1)49470X01275(2)B(3)	2.7	5	0.480 (12.19)	K, M	N, L, M, J, K	L1X(3)501275(2)(4)48
(1)49470X01335(2)B(3)	3.3	5	0.650 (16.51)	K, M	N, L, M, J, K	L1X(3)501335(2)(4)65
(1)49470X01395(2)B(3)	3.9	4	0.360 (9.14)	K, M	N, L, M, J, K	L1X(3)401395(2)(4)36
(1)49470X01475(2)B(3)	4.7	4	0.360 (9.14)	K, M	N, L, M, J, K	L1X(3)401475(2)(4)36
(1)49470X01565(2)B(3)	5.6	4	0.480 (12.19)	K, M	N, L, M, J, K	L1X(3)401565(2)(4)48
(1)49470X01685(2)B(3)	6.8	4	0.480 (12.19)	K, M	N, L, M, J, K	L1X(3)401685(2)(4)48
(1)49470X01825(2)B(3)	8.2	4	0.650 (16.51)	K, M	N, L, M, J, K	L1X(3)401825(2)(4)65
(1)49470X01106(2)B(3)	10	3	0.240 (6.10)	K, M	N, L, M, J, K	L1X(3)301106(2)(4)24
(1)49470X01126(2)B(3)	12	3	0.240 (6.10)	K, M	N, L, M, J, K	L1X(3)301126(2)(4)24
(1)49470X01156(2)B(3)	15	3	0.360 (9.14)	K, M	N, L, M, J, K	L1X(3)301156(2)(4)36
(1)49470X01186(2)B(3)	18	3	0.360 (9.14)	K, M	N, L, M, J, K	L1X(3)301186(2)(4)36
(1)49470X01226(2)B(3)	22	3	0.480 (12.19)	K, M	N, L, M, J, K	L1X(3)301226(2)(4)48
(1)49470X01276(2)B(3)	27	3	0.650 (16.51)	K, M	N, L, M, J, K	L1X(3)301276(2)(4)65
200 VDC – BR Dielectric						
(1)49470R01474(2)C(3)	0.47	5	0.240 (6.10)	K, M	N, L, M, J, K	L1R(3)502474(2)(4)24
(1)49470R01564(2)C(3)	0.56	5	0.240 (6.10)	K, M	N, L, M, J, K	L1R(3)502564(2)(4)24
(1)49470R01684(2)C(3)	0.68	5	0.360 (9.14)	K, M	N, L, M, J, K	L1R(3)502684(2)(4)36
(1)49470R01824(2)C(3)	0.82	5	0.360 (9.14)	K, M	N, L, M, J, K	L1R(3)502824(2)(4)36
(1)49470R01105(2)C(3)	1	5	0.480 (12.19)	K, M	N, L, M, J, K	L1R(3)502105(2)(4)48
MIL-PRF-49470 P/N ¹	Capacitance (μF)	Case Code	Height A inch (mm)	Capacitance Tolerance	Lead Configuration	KEMET P/N ¹

¹ Complete P/N requires additional characters in the numbered positions provided in order to indicate product level (B level or T level), capacitance tolerance and lead configuration. For each numbered position, available options are as follows:

- (1) Test level character "M" for B level, or "T" for T level (MIL-PRF-49470/1 part number only).
- (2) Capacitance tolerance character "K" or "M".
- (3) Lead style character "N", "L", "M", "J" or "K".
- (4) Test level character "B" for B level, or "T" for T level (KEMET part number only).

Table 1A – MIL-PRF-49470 /1, Product Selection 200 – 500 VDC cont'd

MIL-PRF-49470/1 Unencapsulated, Horizontally Stacked						
MIL-PRF-49470 P/N ¹	Capacitance (µF)	Case Code	Height A inch (mm)	Capacitance Tolerance	Lead Configuration	KEMET P/N ¹
(1)49470R01125(2)C(3)	1.2	5	0.480 (12.19)	K, M	N, L, M, J, K	L1R(3)502125(2)(4)48
(1)49470R01155(2)C(3)	1.5	5	0.650 (16.51)	K, M	N, L, M, J, K	L1R(3)502155(2)(4)65
(1)49470R01185(2)C(3)	1.8	4	0.360 (9.14)	K, M	N, L, M, J, K	L1R(3)402185(2)(4)36
(1)49470R01225(2)C(3)	2.2	4	0.360 (9.14)	K, M	N, L, M, J, K	L1R(3)402225(2)(4)36
(1)49470R01275(2)C(3)	2.7	4	0.480 (12.19)	K, M	N, L, M, J, K	L1R(3)402275(2)(4)48
(1)49470R01335(2)C(3)	3.3	4	0.480 (12.19)	K, M	N, L, M, J, K	L1R(3)402335(2)(4)48
(1)49470R01395(2)C(3)	3.9	4	0.650 (16.51)	K, M	N, L, M, J, K	L1R(3)402395(2)(4)65
(1)49470R01475(2)C(3)	4.7	3	0.240 (6.10)	K, M	N, L, M, J, K	L1R(3)302475(2)(4)24
(1)49470R01565(2)C(3)	5.6	3	0.240 (6.10)	K, M	N, L, M, J, K	L1R(3)302565(2)(4)24
(1)49470R01685(2)C(3)	6.8	3	0.360 (9.14)	K, M	N, L, M, J, K	L1R(3)302685(2)(4)36
(1)49470R01825(2)C(3)	8.2	3	0.360 (9.14)	K, M	N, L, M, J, K	L1R(3)302825(2)(4)36
(1)49470R01106(2)C(3)	10	3	0.480 (12.19)	K, M	N, L, M, J, K	L1R(3)302106(2)(4)48
(1)49470R01126(2)C(3)	12	3	0.650 (16.51)	K, M	N, L, M, J, K	L1R(3)302126(2)(4)65
500 VDC – BQ Dielectric						
(1)49470Q01154(2)E(3)	0.15	5	0.120 (3.05)	K, M	N, L, M, J, K	L1Q(3)50C154(2)(4)12
(1)49470Q01184(2)E(3)	0.18	5	0.240 (6.10)	K, M	N, L, M, J, K	L1Q(3)50C184(2)(4)24
(1)49470Q01224(2)E(3)	0.22	5	0.240 (6.10)	K, M	N, L, M, J, K	L1Q(3)50C224(2)(4)24
(1)49470Q01274(2)E(3)	0.27	5	0.240 (6.10)	K, M	N, L, M, J, K	L1Q(3)50C274(2)(4)24
(1)49470Q01334(2)E(3)	0.33	5	0.360 (9.14)	K, M	N, L, M, J, K	L1Q(3)50C334(2)(4)36
(1)49470Q01394(2)E(3)	0.39	5	0.360 (9.14)	K, M	N, L, M, J, K	L1Q(3)50C394(2)(4)36
(1)49470Q01474(2)E(3)	0.47	5	0.360 (9.14)	K, M	N, L, M, J, K	L1Q(3)50C474(2)(4)36
(1)49470Q01564(2)E(3)	0.56	5	0.480 (12.19)	K, M	N, L, M, J, K	L1Q(3)50C564(2)(4)48
(1)49470Q01684(2)E(3)	0.68	5	0.650 (16.51)	K, M	N, L, M, J, K	L1Q(3)50C684(2)(4)65
(1)49470Q01824(2)E(3)	0.82	4	0.360 (9.14)	K, M	N, L, M, J, K	L1Q(3)40C824(2)(4)36
(1)49470Q01105(2)E(3)	1	4	0.360 (9.14)	K, M	N, L, M, J, K	L1Q(3)40C105(2)(4)36
(1)49470Q01125(2)E(3)	1.2	4	0.360 (9.14)	K, M	N, L, M, J, K	L1Q(3)40C125(2)(4)36
(1)49470Q01155(2)E(3)	1.5	4	0.480 (12.19)	K, M	N, L, M, J, K	L1Q(3)40C155(2)(4)48
(1)49470Q01185(2)E(3)	1.8	4	0.650 (16.51)	K, M	N, L, M, J, K	L1Q(3)40C185(2)(4)65
(1)49470Q01225(2)E(3)	2.2	3	0.240 (6.10)	K, M	N, L, M, J, K	L1Q(3)30C225(2)(4)24
(1)49470Q01275(2)E(3)	2.7	3	0.360 (9.14)	K, M	N, L, M, J, K	L1Q(3)30C275(2)(4)36
(1)49470Q01335(2)E(3)	3.3	3	0.360 (9.14)	K, M	N, L, M, J, K	L1Q(3)30C335(2)(4)36
(1)49470Q01395(2)E(3)	3.9	3	0.360 (9.14)	K, M	N, L, M, J, K	L1Q(3)30C395(2)(4)36
(1)49470Q01475(2)E(3)	4.7	3	0.480 (12.19)	K, M	N, L, M, J, K	L1Q(3)30C475(2)(4)48
(1)49470Q01565(2)E(3)	5.6	3	0.650 (16.51)	K, M	N, L, M, J, K	L1Q(3)30C565(2)(4)65
MIL-PRF-49470 P/N ¹	Capacitance (µF)	Case Code	Height A inch (mm)	Capacitance Tolerance	Lead Configuration	KEMET P/N ¹

¹ Complete P/N requires additional characters in the numbered positions provided in order to indicate product level (B level or T level), capacitance tolerance and lead configuration. For each numbered position, available options are as follows:

- (1) Test level character "M" for B level, or "T" for T level (MIL-PRF-49470/1 part number only).
- (2) Capacitance tolerance character "K" or "M".
- (3) Lead style character "N", "L", "M", "J" or "K".
- (4) Test level character "B" for B level, or "T" for T level (KEMET part number only).

Table 1B – MIL-PRF-49470/2, Product Selection 50 – 200 VDC

MIL-PRF-49470/2 Encapsulated, Horizontally Stacked						
MIL-PRF-49470 P/N ¹	Capacitance (µF)	Case Code	Height A inch (mm)	Capacitance Tolerance	Lead Configuration	KEMET P/N ¹
50 VDC – BX Dielectric						
M49470X02125(1)A(2)	1.2	5	0.270 (6.86)	K, M	N, L, M, J, K	L2X(2)505125(1)B27
M49470X02155(1)A(2)	1.5	5	0.390 (9.91)	K, M	N, L, M, J, K	L2X(2)505155(1)B39
M49470X02185(1)A(2)	1.8	5	0.390 (9.91)	K, M	N, L, M, J, K	L2X(2)505185(1)B39
M49470X02225(1)A(2)	2.2	5	0.390 (9.91)	K, M	N, L, M, J, K	L2X(2)505225(1)B39
M49470X02275(1)A(2)	2.7	5	0.530 (13.46)	K, M	N, L, M, J, K	L2X(2)505275(1)B53
M49470X02335(1)A(2)	3.3	5	0.530 (13.46)	K, M	N, L, M, J, K	L2X(2)505335(1)B53
M49470X02475(1)A(2)	3.9	5	0.660 (16.76)	K, M	N, L, M, J, K	L2X(2)505475(1)B66
M49470X02395(1)A(2)	4.7	5	0.660 (16.76)	K, M	N, L, M, J, K	L2X(2)505395(1)B66
M49470X02565(1)A(2)	5.6	5	0.800 (20.32)	K, M	N, L, M, J, K	L2X(2)505565(1)B80
M49470X02685(1)A(2)	6.8	4	0.530 (13.46)	K, M	N, L, M, J, K	L2X(2)405685(1)B53
M49470X02825(1)A(2)	8.2	4	0.530 (13.46)	K, M	N, L, M, J, K	L2X(2)405825(1)B53
M49470X02106(1)A(2)	10	4	0.660 (16.76)	K, M	N, L, M, J, K	L2X(2)405106(1)B66
M49470X02126(1)A(2)	12	4	0.660 (16.76)	K, M	N, L, M, J, K	L2X(2)405126(1)B66
M49470X02156(1)A(2)	15	4	0.800 (20.32)	K, M	N, L, M, J, K	L2X(2)405156(1)B80
M49470X02186(1)A(2)	18	3	0.390 (9.91)	K, M	N, L, M, J, K	L2X(2)305186(1)B39
M49470X02226(1)A(2)	22	3	0.530 (13.46)	K, M	N, L, M, J, K	L2X(2)305226(1)B53
M49470X02276(1)A(2)	27	3	0.530 (13.46)	K, M	N, L, M, J, K	L2X(2)305276(1)B53
M49470X02336(1)A(2)	33	3	0.530 (13.46)	K, M	N, L, M, J, K	L2X(2)305336(1)B53
M49470X02396(1)A(2)	39	3	0.660 (16.76)	K, M	N, L, M, J, K	L2X(2)305396(1)B66
M49470X02476(1)A(2)	47	3	0.800 (20.32)	K, M	N, L, M, J, K	L2X(2)305476(1)B80
100 VDC – BX Dielectric						
M49470X02684(1)B(2)	0.68	5	0.270 (6.86)	K, M	N, L, M, J, K	L2X(2)501684(1)B27
M49470X02824(1)B(2)	0.82	5	0.390 (9.91)	K, M	N, L, M, J, K	L2X(2)501824(1)B39
M49470X02105(1)B(2)	1	5	0.390 (9.91)	K, M	N, L, M, J, K	L2X(2)501105(1)B39
M49470X02125(1)B(2)	1.2	5	0.390 (9.91)	K, M	N, L, M, J, K	L2X(2)501125(1)B39
M49470X02155(1)B(2)	1.5	5	0.530 (13.46)	K, M	N, L, M, J, K	L2X(2)501155(1)B53
M49470X02185(1)B(2)	1.8	5	0.530 (13.46)	K, M	N, L, M, J, K	L2X(2)501185(1)B53
M49470X02225(1)B(2)	2.2	5	0.660 (16.76)	K, M	N, L, M, J, K	L2X(2)501225(1)B66
M49470X02275(1)B(2)	2.7	5	0.660 (16.76)	K, M	N, L, M, J, K	L2X(2)501275(1)B66
M49470X02335(1)B(2)	3.3	5	0.800 (20.32)	K, M	N, L, M, J, K	L2X(2)501335(1)B80
M49470X02395(1)B(2)	3.9	4	0.530 (13.46)	K, M	N, L, M, J, K	L2X(2)401395(1)B53
M49470X02475(1)B(2)	4.7	4	0.530 (13.46)	K, M	N, L, M, J, K	L2X(2)401475(1)B53
M49470X02565(1)B(2)	5.6	4	0.660 (16.76)	K, M	N, L, M, J, K	L2X(2)401565(1)B66
M49470X02685(1)B(2)	6.8	4	0.660 (16.76)	K, M	N, L, M, J, K	L2X(2)401685(1)B66
M49470X02825(1)B(2)	8.2	4	0.800 (20.32)	K, M	N, L, M, J, K	L2X(2)401825(1)B80
M49470X02106(1)B(2)	10	3	0.390 (9.91)	K, M	N, L, M, J, K	L2X(2)301106(1)B39
M49470X02126(1)B(2)	12	3	0.390 (9.91)	K, M	N, L, M, J, K	L2X(2)301126(1)B39
M49470X02156(1)B(2)	15	3	0.530 (13.46)	K, M	N, L, M, J, K	L2X(2)301156(1)B53
M49470X02186(1)B(2)	18	3	0.530 (13.46)	K, M	N, L, M, J, K	L2X(2)301186(1)B53
M49470X02226(1)B(2)	22	3	0.660 (16.76)	K, M	N, L, M, J, K	L2X(2)301226(1)B66
M49470X02276(1)B(2)	27	3	0.800 (20.32)	K, M	N, L, M, J, K	L2X(2)301276(1)B80
200 VDC – BR Dielectric						
M49470R02474(1)C(2)	0.47	5	0.390 (9.91)	K, M	N, L, M, J, K	L2R(2)502474(1)B39
M49470R02564(1)C(2)	0.56	5	0.390 (9.91)	K, M	N, L, M, J, K	L2R(2)502564(1)B39
M49470R02684(1)C(2)	0.68	5	0.530 (13.46)	K, M	N, L, M, J, K	L2R(2)502684(1)B53
M49470R02824(1)C(2)	0.82	5	0.530 (13.46)	K, M	N, L, M, J, K	L2R(2)502824(1)B53
M49470R02105(1)C(2)	1	5	0.660 (16.76)	K, M	N, L, M, J, K	L2R(2)502105(1)B66
M49470R02125(1)C(2)	1.2	5	0.660 (16.76)	K, M	N, L, M, J, K	L2R(2)502125(1)B66
M49470R02155(1)C(2)	1.5	5	0.800 (20.32)	K, M	N, L, M, J, K	L2R(2)502155(1)B80
M49470R02185(1)C(2)	1.8	4	0.530 (13.46)	K, M	N, L, M, J, K	L2R(2)402185(1)B53
M49470R02225(1)C(2)	2.2	4	0.530 (13.46)	K, M	N, L, M, J, K	L2R(2)402225(1)B53
MIL-PRF-49470 P/N ¹	Capacitance (µF)	Case Code	Height A inch (mm)	Capacitance Tolerance	Lead Configuration	KEMET P/N ¹

¹ Complete P/N requires additional characters in the numbered positions provided in order to indicate capacitance tolerance and lead configuration. For each numbered position, available options are as follows:

- (1) Capacitance tolerance character "K" or "M".
- (2) Lead style character "N", "L", "M", "J" or "K".

Table 1B – MIL-PRF-49470 /2, Product Selection 200 – 500 VDC cont'd

MIL-PRF-49470/2 Encapsulated, Horizontally Stacked						
MIL-PRF-49470 P/N ¹	Capacitance (µF)	Case Code	Height A inch (mm)	Capacitance Tolerance	Lead Configuration	KEMET P/N ¹
M49470R02275(1)C(2)	2.7	4	0.660 (16.76)	K, M	N, L, M, J, K	L2R(2)402275(1)B66
M49470R02335(1)C(2)	3.3	4	0.660 (16.76)	K, M	N, L, M, J, K	L2R(2)402335(1)B66
M49470R02395(1)C(2)	3.9	4	0.800 (20.32)	K, M	N, L, M, J, K	L2R(2)402395(1)B80
M49470R02475(1)C(2)	4.7	3	0.390 (9.91)	K, M	N, L, M, J, K	L2R(2)302475(1)B39
M49470R02565(1)C(2)	5.6	3	0.390 (9.91)	K, M	N, L, M, J, K	L2R(2)302565(1)B39
M49470R02685(1)C(2)	6.8	3	0.530 (13.46)	K, M	N, L, M, J, K	L2R(2)302685(1)B53
M49470R02825(1)C(2)	8.2	3	0.530 (13.46)	K, M	N, L, M, J, K	L2R(2)302825(1)B53
M49470R02106(1)C(2)	10	3	0.660 (16.76)	K, M	N, L, M, J, K	L2R(2)302106(1)B66
M49470R02126(1)C(2)	12	3	0.800 (20.32)	K, M	N, L, M, J, K	L2R(2)302126(1)B80
500 VDC – BQ Dielectric						
M49470Q02154(1)E(2)	0.15	5	0.270 (6.86)	K, M	N, L, M, J, K	L2Q(2)50C154(1)B27
M49470Q02184(1)E(2)	0.18	5	0.390 (9.91)	K, M	N, L, M, J, K	L2Q(2)50C184(1)B39
M49470Q02224(1)E(2)	0.22	5	0.390 (9.91)	K, M	N, L, M, J, K	L2Q(2)50C224(1)B39
M49470Q02274(1)E(2)	0.27	5	0.390 (9.91)	K, M	N, L, M, J, K	L2Q(2)50C274(1)B39
M49470Q02334(1)E(2)	0.33	5	0.530 (13.46)	K, M	N, L, M, J, K	L2Q(2)50C334(1)B53
M49470Q02394(1)E(2)	0.39	5	0.530 (13.46)	K, M	N, L, M, J, K	L2Q(2)50C394(1)B53
M49470Q02474(1)E(2)	0.47	5	0.530 (13.46)	K, M	N, L, M, J, K	L2Q(2)50C474(1)B53
M49470Q02564(1)E(2)	0.56	5	0.660 (16.76)	K, M	N, L, M, J, K	L2Q(2)50C564(1)B66
M49470Q02684(1)E(2)	0.68	5	0.800 (20.32)	K, M	N, L, M, J, K	L2Q(2)50C684(1)B80
M49470Q02824(1)E(2)	0.82	4	0.530 (13.46)	K, M	N, L, M, J, K	L2Q(2)40C824(1)B53
M49470Q02105(1)E(2)	1	4	0.530 (13.46)	K, M	N, L, M, J, K	L2Q(2)40C105(1)B53
M49470Q02125(1)E(2)	1.2	4	0.530 (13.46)	K, M	N, L, M, J, K	L2Q(2)40C125(1)B53
M49470Q02155(1)E(2)	1.5	4	0.660 (16.76)	K, M	N, L, M, J, K	L2Q(2)40C155(1)B66
M49470Q02185(1)E(2)	1.8	4	0.800 (20.32)	K, M	N, L, M, J, K	L2Q(2)40C185(1)B80
M49470Q02225(1)E(2)	2.2	3	0.390 (9.91)	K, M	N, L, M, J, K	L2Q(2)30C225(1)B39
M49470Q02275(1)E(2)	2.7	3	0.530 (13.46)	K, M	N, L, M, J, K	L2Q(2)30C275(1)B53
M49470Q02335(1)E(2)	3.3	3	0.530 (13.46)	K, M	N, L, M, J, K	L2Q(2)30C335(1)B53
M49470Q02395(1)E(2)	3.9	3	0.530 (13.46)	K, M	N, L, M, J, K	L2Q(2)30C395(1)B53
M49470Q02475(1)E(2)	4.7	3	0.660 (16.76)	K, M	N, L, M, J, K	L2Q(2)30C475(1)B66
M49470Q02565(1)E(2)	5.6	3	0.800 (20.32)	K, M	N, L, M, J, K	L2Q(2)30C565(1)B80
M49470Q02565(1)E(2)	5.6	3	0.800 (20.32)	K, M	N, L, M, J, K	L2Q(2)30C565(1)B65
MIL-PRF-49470 P/N ¹	Capacitance (µF)	Case Code	Height A inch (mm)	Capacitance Tolerance	Lead Configuration	KEMET P/N ¹

¹ Complete P/N requires additional characters in the numbered positions provided in order to indicate capacitance tolerance and lead configuration. For each numbered position, available options are as follows:

- (1) Capacitance tolerance character "K" or "M".
- (2) Lead style character "N", "L", "M", "J" or "K".

Table 1C – Product Selection 25 VDC

Commercial/Non-Standard – Customer Specific Unencapsulated, Horizontally Stacked					
KEMET P/N ¹	Capacitance (µF)	Case Code	Height A inch (mm)	Capacitance Tolerance	Lead Configuration
25 VDC – BX Dielectric					
L1X(1)503824(2)(3)12	0.82	5	0.120 (3.05)	K, M	N, L, M, J, K
L1X(1)503105(2)(3)12	1	5	0.120 (3.05)	K, M	N, L, M, J, K
L1X(1)503125(2)(3)12	1.2	5	0.120 (3.05)	K, M	N, L, M, J, K
L1X(1)503155(2)(3)12	1.5	5	0.120 (3.05)	K, M	N, L, M, J, K
L1X(1)503185(2)(3)24	1.8	5	0.240 (6.10)	K, M	N, L, M, J, K
L1X(1)403225(2)(3)12	2.2	4	0.120 (3.05)	K, M	N, L, M, J, K
L1X(1)503225(2)(3)24	2.2	5	0.240 (6.10)	K, M	N, L, M, J, K
L1X(1)503255(2)(3)24	2.5	5	0.240 (6.10)	K, M	N, L, M, J, K
L1X(1)403275(2)(3)12	2.7	4	0.120 (3.05)	K, M	N, L, M, J, K
L1X(1)503275(2)(3)24	2.7	5	0.240 (6.10)	K, M	N, L, M, J, K
L1X(1)403335(2)(3)12	3.3	4	0.120 (3.05)	K, M	N, L, M, J, K
L1X(1)503335(2)(3)36	3.3	5	0.360 (9.14)	K, M	N, L, M, J, K
L1X(1)403395(2)(3)12	3.9	4	0.120 (3.05)	K, M	N, L, M, J, K
L1X(1)503395(2)(3)36	3.9	5	0.360 (9.14)	K, M	N, L, M, J, K
L1X(1)403475(2)(3)12	4.7	4	0.120 (3.05)	K, M	N, L, M, J, K
L1X(1)503475(2)(3)36	4.7	5	0.360 (9.14)	K, M	N, L, M, J, K
L1X(1)403565(2)(3)24	5.6	4	0.240 (6.10)	K, M	N, L, M, J, K
L1X(1)503565(2)(3)48	5.6	5	0.480 (12.19)	K, M	N, L, M, J, K
L1X(1)403605(2)(3)24	6	4	0.240 (6.10)	K, M	N, L, M, J, K
L1X(1)503605(2)(3)48	6	5	0.480 (12.19)	K, M	N, L, M, J, K
L1X(1)303685(2)(3)12	6.8	3	0.120 (3.05)	K, M	N, L, M, J, K
L1X(1)403685(2)(3)24	6.8	4	0.240 (6.10)	K, M	N, L, M, J, K
L1X(1)503685(2)(3)65	6.8	5	0.650 (16.51)	K, M	N, L, M, J, K
L1X(1)403755(2)(3)24	7.5	4	0.240 (6.10)	K, M	N, L, M, J, K
L1X(1)503755(2)(3)65	7.5	5	0.650 (16.51)	K, M	N, L, M, J, K
L1X(1)303825(2)(3)12	8.2	3	0.120 (3.05)	K, M	N, L, M, J, K
L1X(1)403825(2)(3)24	8.2	4	0.240 (6.10)	K, M	N, L, M, J, K
L1X(1)303106(2)(3)12	10	3	0.120 (3.05)	K, M	N, L, M, J, K
L1X(1)403106(2)(3)24	10	4	0.240 (6.10)	K, M	N, L, M, J, K
L1X(1)303116(2)(3)12	11	3	0.120 (3.05)	K, M	N, L, M, J, K
L1X(1)303126(2)(3)12	12	3	0.120 (3.05)	K, M	N, L, M, J, K
L1X(1)403126(2)(3)36	12	4	0.360 (9.14)	K, M	N, L, M, J, K
L1X(1)303156(2)(3)12	15	3	0.120 (3.05)	K, M	N, L, M, J, K
L1X(1)403156(2)(3)36	15	4	0.360 (9.14)	K, M	N, L, M, J, K
L1X(1)303166(2)(3)24	16	3	0.240 (6.10)	K, M	N, L, M, J, K
L1X(1)403166(2)(3)48	16	4	0.480 (12.19)	K, M	N, L, M, J, K
L1X(1)303186(2)(3)24	18	3	0.240 (6.10)	K, M	N, L, M, J, K
L1X(1)403186(2)(3)48	18	4	0.480 (12.19)	K, M	N, L, M, J, K
L1X(1)303206(2)(3)24	20	3	0.240 (6.10)	K, M	N, L, M, J, K
L1X(1)403206(2)(3)48	20	4	0.480 (12.19)	K, M	N, L, M, J, K
L1X(1)303226(2)(3)24	22	3	0.240 (6.10)	K, M	N, L, M, J, K
L1X(1)403226(2)(3)65	22	4	0.650 (16.51)	K, M	N, L, M, J, K
L1X(1)403246(2)(3)65	24	4	0.650 (16.51)	K, M	N, L, M, J, K
L1X(1)303276(2)(3)24	27	3	0.240 (6.10)	K, M	N, L, M, J, K
L1X(1)303306(2)(3)24	30	3	0.240 (6.10)	K, M	N, L, M, J, K
L1X(1)303306(2)(3)36	30	3	0.360 (9.14)	K, M	N, L, M, J, K
L1X(1)303336(2)(3)36	33	3	0.360 (9.14)	K, M	N, L, M, J, K
L1X(1)303396(2)(3)36	39	3	0.360 (9.14)	K, M	N, L, M, J, K
L1X(1)303456(2)(3)36	45	3	0.360 (9.14)	K, M	N, L, M, J, K
L1X(1)303506(2)(3)48	50	3	0.480 (12.19)	K, M	N, L, M, J, K
L1X(1)303546(2)(3)48	54	3	0.480 (12.19)	K, M	N, L, M, J, K
L1X(1)303606(2)(3)48	60	3	0.480 (12.19)	K, M	N, L, M, J, K
L1X(1)303666(2)(3)65	66	3	0.650 (16.51)	K, M	N, L, M, J, K
KEMET P/N ¹	Capacitance (µF)	Case Code	Height A inch (mm)	Capacitance Tolerance	Lead Configuration

¹ Complete part number requires additional characters in the numbered positions provided in order to indicate testing option, capacitance tolerance and lead configuration. For each numbered position, available options are as follows:

- (1) Lead style character "N", "L", "M", "J" or "K".
- (2) Capacitance tolerance character "K" or "M".
- (3) Testing option character "S" for Commercial, or "X" for non-standard (customer specific).

Table 1C – Commercial/Non-Standard – Product Selection 25 – 50 VDC cont'd

Commercial/Non-Standard – Customer Specific Unencapsulated, Horizontally Stacked					
KEMET P/N ¹	Capacitance (µF)	Case Code	Height A inch (mm)	Capacitance Tolerance	Lead Configuration
L1X(1)303726(2)(3)65	72	3	0.650 (16.51)	K, M	N, L, M, J, K
L1X(1)303756(2)(3)65	75	3	0.650 (16.51)	K, M	N, L, M, J, K
50 VDC – BX Dielectric					
L1X(1)505824(2)(3)12	0.82	5	0.120 (3.05)	K, M	N, L, M, J, K
L1X(1)505105(2)(3)12	1	5	0.120 (3.05)	K, M	N, L, M, J, K
L1X(1)505125(2)(3)12	1.2	5	0.120 (3.05)	K, M	N, L, M, J, K
L1X(1)505155(2)(3)12	1.5	5	0.120 (3.05)	K, M	N, L, M, J, K
L1X(1)505185(2)(3)24	1.8	5	0.240 (6.10)	K, M	N, L, M, J, K
L1X(1)405225(2)(3)12	2.2	4	0.120 (3.05)	K, M	N, L, M, J, K
L1X(1)505225(2)(3)24	2.2	5	0.240 (6.10)	K, M	N, L, M, J, K
L1X(1)505255(2)(3)24	2.5	5	0.240 (6.10)	K, M	N, L, M, J, K
L1X(1)405275(2)(3)12	2.7	4	0.120 (3.05)	K, M	N, L, M, J, K
L1X(1)505275(2)(3)24	2.7	5	0.240 (6.10)	K, M	N, L, M, J, K
L1X(1)505275(2)(3)36	2.7	5	0.360 (9.14)	K, M	N, L, M, J, K
L1X(1)405335(2)(3)12	3.3	4	0.120 (3.05)	K, M	N, L, M, J, K
L1X(1)505335(2)(3)36	3.3	5	0.360 (9.14)	K, M	N, L, M, J, K
L1X(1)405395(2)(3)12	3.9	4	0.120 (3.05)	K, M	N, L, M, J, K
L1X(1)505395(2)(3)36	3.9	5	0.360 (9.14)	K, M	N, L, M, J, K
L1X(1)405475(2)(3)12	4.7	4	0.120 (3.05)	K, M	N, L, M, J, K
L1X(1)505475(2)(3)36	4.7	5	0.360 (9.14)	K, M	N, L, M, J, K
L1X(1)405565(2)(3)24	5.6	4	0.240 (6.10)	K, M	N, L, M, J, K
L1X(1)505565(2)(3)48	5.6	5	0.480 (12.19)	K, M	N, L, M, J, K
L1X(1)405605(2)(3)24	6	4	0.240 (6.10)	K, M	N, L, M, J, K
L1X(1)505605(2)(3)48	6	5	0.480 (12.19)	K, M	N, L, M, J, K
L1X(1)305685(2)(3)12	6.8	3	0.120 (3.05)	K, M	N, L, M, J, K
L1X(1)405685(2)(3)24	6.8	4	0.240 (6.10)	K, M	N, L, M, J, K
L1X(1)505685(2)(3)65	6.8	5	0.650 (16.51)	K, M	N, L, M, J, K
L1X(1)405755(2)(3)24	7.5	4	0.240 (6.10)	K, M	N, L, M, J, K
L1X(1)505755(2)(3)65	7.5	5	0.650 (16.51)	K, M	N, L, M, J, K
L1X(1)305825(2)(3)12	8.2	3	0.120 (3.05)	K, M	N, L, M, J, K
L1X(1)405825(2)(3)24	8.2	4	0.240 (6.10)	K, M	N, L, M, J, K
L1X(1)305106(2)(3)12	10	3	0.120 (3.05)	K, M	N, L, M, J, K
L1X(1)405106(2)(3)24	10	4	0.240 (6.10)	K, M	N, L, M, J, K
L1X(1)305116(2)(3)12	11	3	0.120 (3.05)	K, M	N, L, M, J, K
L1X(1)305126(2)(3)12	12	3	0.120 (3.05)	K, M	N, L, M, J, K
L1X(1)405126(2)(3)36	12	4	0.360 (9.14)	K, M	N, L, M, J, K
L1X(1)305156(2)(3)12	15	3	0.120 (3.05)	K, M	N, L, M, J, K
L1X(1)405156(2)(3)36	15	4	0.360 (9.14)	K, M	N, L, M, J, K
L1X(1)305166(2)(3)24	16	3	0.240 (6.10)	K, M	N, L, M, J, K
L1X(1)405166(2)(3)48	16	4	0.480 (12.19)	K, M	N, L, M, J, K
L1X(1)305186(2)(3)24	18	3	0.240 (6.10)	K, M	N, L, M, J, K
L1X(1)405186(2)(3)48	18	4	0.480 (12.19)	K, M	N, L, M, J, K
L1X(1)305206(2)(3)24	20	3	0.240 (6.10)	K, M	N, L, M, J, K
L1X(1)405206(2)(3)48	20	4	0.480 (12.19)	K, M	N, L, M, J, K
L1X(1)305226(2)(3)24	22	3	0.240 (6.10)	K, M	N, L, M, J, K
L1X(1)405226(2)(3)65	22	4	0.650 (16.51)	K, M	N, L, M, J, K
L1X(1)405246(2)(3)65	24	4	0.650 (16.51)	K, M	N, L, M, J, K
L1X(1)305276(2)(3)24	27	3	0.240 (6.10)	K, M	N, L, M, J, K
L1X(1)305306(2)(3)24	30	3	0.240 (6.10)	K, M	N, L, M, J, K
L1X(1)305336(2)(3)36	33	3	0.360 (9.14)	K, M	N, L, M, J, K
L1X(1)305396(2)(3)36	39	3	0.360 (9.14)	K, M	N, L, M, J, K
L1X(1)305456(2)(3)36	45	3	0.360 (9.14)	K, M	N, L, M, J, K
L1X(1)305506(2)(3)48	50	3	0.480 (12.19)	K, M	N, L, M, J, K
KEMET P/N ¹	Capacitance (µF)	Case Code	Height A inch (mm)	Capacitance Tolerance	Lead Configuration

¹ Complete part number requires additional characters in the numbered positions provided in order to indicate testing option, capacitance tolerance and lead configuration. For each numbered position, available options are as follows:

- (1) Lead style character "N", "L", "M", "J" or "K".
- (2) Capacitance tolerance character "K" or "M".
- (3) Testing option character "S" for Commercial, or "X" for non-standard (customer specific).

Table 1C – Commercial/Non-Standard – Product Selection 50 – 100 VDC cont'd

Commercial/Non-Standard – Customer Specific Unencapsulated, Horizontally Stacked					
KEMET P/N ¹	Capacitance (µF)	Case Code	Height A inch (mm)	Capacitance Tolerance	Lead Configuration
L1X(1)305546(2)(3)48	54	3	0.480 (12.19)	K, M	N, L, M, J, K
L1X(1)305606(2)(3)48	60	3	0.480 (12.19)	K, M	N, L, M, J, K
L1X(1)305666(2)(3)65	66	3	0.650 (16.51)	K, M	N, L, M, J, K
L1X(1)305726(2)(3)65	72	3	0.650 (16.51)	K, M	N, L, M, J, K
L1X(1)305756(2)(3)65	75	3	0.650 (16.51)	K, M	N, L, M, J, K
100 VDC – BR Dielectric					
L1R(1)501564(2)(3)12	0.56	5	0.120 (3.05)	K, M	N, L, M, J, K
L1R(1)501684(2)(3)12	0.68	5	0.120 (3.05)	K, M	N, L, M, J, K
L1R(1)501754(2)(3)12	0.75	5	0.120 (3.05)	K, M	N, L, M, J, K
L1R(1)501824(2)(3)12	0.82	5	0.120 (3.05)	K, M	N, L, M, J, K
L1R(1)501105(2)(3)12	1	5	0.120 (3.05)	K, M	N, L, M, J, K
L1R(1)501125(2)(3)12	1.2	5	0.120 (3.05)	K, M	N, L, M, J, K
L1R(1)401155(2)(3)12	1.5	4	0.120 (3.05)	K, M	N, L, M, J, K
L1R(1)501155(2)(3)24	1.5	5	0.240 (6.10)	K, M	N, L, M, J, K
L1R(1)401185(2)(3)12	1.8	4	0.120 (3.05)	K, M	N, L, M, J, K
L1R(1)501185(2)(3)24	1.8	5	0.240 (6.10)	K, M	N, L, M, J, K
L1R(1)401225(2)(3)12	2.2	4	0.120 (3.05)	K, M	N, L, M, J, K
L1R(1)501225(2)(3)24	2.2	5	0.240 (6.10)	K, M	N, L, M, J, K
L1R(1)501255(2)(3)24	2.5	5	0.240 (6.10)	K, M	N, L, M, J, K
L1R(1)401275(2)(3)12	2.7	4	0.120 (3.05)	K, M	N, L, M, J, K
L1R(1)501275(2)(3)36	2.7	5	0.360 (9.14)	K, M	N, L, M, J, K
L1R(1)401335(2)(3)12	3.3	4	0.120 (3.05)	K, M	N, L, M, J, K
L1R(1)501335(2)(3)36	3.3	5	0.360 (9.14)	K, M	N, L, M, J, K
L1R(1)401395(2)(3)12	3.9	4	0.120 (3.05)	K, M	N, L, M, J, K
L1R(1)501395(2)(3)48	3.9	5	0.480 (12.19)	K, M	N, L, M, J, K
L1R(1)401475(2)(3)24	4.7	4	0.240 (6.10)	K, M	N, L, M, J, K
L1R(1)501475(2)(3)48	4.7	5	0.480 (12.19)	K, M	N, L, M, J, K
L1R(1)301565(2)(3)12	5.6	3	0.120 (3.05)	K, M	N, L, M, J, K
L1R(1)401565(2)(3)24	5.6	4	0.240 (6.10)	K, M	N, L, M, J, K
L1R(1)501565(2)(3)65	5.6	5	0.650 (16.51)	K, M	N, L, M, J, K
L1R(1)301605(2)(3)12	6	3	0.120 (3.05)	K, M	N, L, M, J, K
L1R(1)401605(2)(3)24	6	4	0.240 (6.10)	K, M	N, L, M, J, K
L1R(1)501605(2)(3)65	6	5	0.650 (16.51)	K, M	N, L, M, J, K
L1R(1)301685(2)(3)12	6.8	3	0.120 (3.05)	K, M	N, L, M, J, K
L1R(1)401685(2)(3)24	6.8	4	0.240 (6.10)	K, M	N, L, M, J, K
L1R(1)401755(2)(3)24	7.5	4	0.240 (6.10)	K, M	N, L, M, J, K
L1R(1)301825(2)(3)12	8.2	3	0.120 (3.05)	K, M	N, L, M, J, K
L1R(1)401825(2)(3)36	8.2	4	0.360 (9.14)	K, M	N, L, M, J, K
L1R(1)301106(2)(3)12	10	3	0.120 (3.05)	K, M	N, L, M, J, K
L1R(1)401106(2)(3)36	10	4	0.360 (9.14)	K, M	N, L, M, J, K
L1R(1)301116(2)(3)12	11	3	0.120 (3.05)	K, M	N, L, M, J, K
L1R(1)301126(2)(3)24	12	3	0.240 (6.10)	K, M	N, L, M, J, K
L1R(1)401126(2)(3)48	12	4	0.480 (12.19)	K, M	N, L, M, J, K
L1R(1)301156(2)(3)24	15	3	0.240 (6.10)	K, M	N, L, M, J, K
L1R(1)401156(2)(3)48	15	4	0.480 (12.19)	K, M	N, L, M, J, K
L1R(1)301166(2)(3)24	16	3	0.240 (6.10)	K, M	N, L, M, J, K
L1R(1)401166(2)(3)65	16	4	0.650 (16.51)	K, M	N, L, M, J, K
L1R(1)301186(2)(3)24	18	3	0.240 (6.10)	K, M	N, L, M, J, K
L1R(1)401186(2)(3)65	18	4	0.650 (16.51)	K, M	N, L, M, J, K
L1R(1)301206(2)(3)24	20	3	0.240 (6.10)	K, M	N, L, M, J, K
L1R(1)301226(2)(3)36	22	3	0.360 (9.14)	K, M	N, L, M, J, K
L1R(1)301276(2)(3)36	27	3	0.360 (9.14)	K, M	N, L, M, J, K
L1R(1)301306(2)(3)36	30	3	0.360 (9.14)	K, M	N, L, M, J, K
KEMET P/N ¹	Capacitance (µF)	Case Code	Height A inch (mm)	Capacitance Tolerance	Lead Configuration

¹ Complete part number requires additional characters in the numbered positions provided in order to indicate testing option, capacitance tolerance and lead configuration. For each numbered position, available options are as follows:

- (1) Lead style character "N", "L", "M", "J" or "K".
- (2) Capacitance tolerance character "K" or "M".
- (3) Testing option character "S" for Commercial, or "X" for non-standard (customer specific).

Table 1C – Commercial/Non-Standard – Product Selection 100 – 200 VDC cont'd

Commercial/Non-Standard – Customer Specific Unencapsulated, Horizontally Stacked					
KEMET P/N ¹	Capacitance (μF)	Case Code	Height A inch (mm)	Capacitance Tolerance	Lead Configuration
L1R(1)301336(2)(3)48	33	3	0.480 (12.19)	K, M	N, L, M, J, K
L1R(1)301396(2)(3)48	39	3	0.480 (12.19)	K, M	N, L, M, J, K
L1R(1)301456(2)(3)65	45	3	0.650 (16.51)	K, M	N, L, M, J, K
L1R(1)301506(2)(3)65	50	3	0.650 (16.51)	K, M	N, L, M, J, K
200 VDC – BQ Dielectric					
L1Q(1)502334(2)(3)12	0.33	5	0.120 (3.05)	K, M	N, L, M, J, K
L1Q(1)502394(2)(3)12	0.39	5	0.120 (3.05)	K, M	N, L, M, J, K
L1Q(1)502474(2)(3)12	0.47	5	0.120 (3.05)	K, M	N, L, M, J, K
L1Q(1)502564(2)(3)12	0.56	5	0.120 (3.05)	K, M	N, L, M, J, K
L1Q(1)502684(2)(3)12	0.68	5	0.120 (3.05)	K, M	N, L, M, J, K
L1Q(1)502754(2)(3)12	0.75	5	0.120 (3.05)	K, M	N, L, M, J, K
L1Q(1)402824(2)(3)12	0.82	4	0.120 (3.05)	K, M	N, L, M, J, K
L1Q(1)502824(2)(3)24	0.82	5	0.240 (6.10)	K, M	N, L, M, J, K
L1Q(1)402105(2)(3)12	1	4	0.120 (3.05)	K, M	N, L, M, J, K
L1Q(1)502105(2)(3)24	1	5	0.240 (6.10)	K, M	N, L, M, J, K
L1Q(1)402125(2)(3)12	1.2	4	0.120 (3.05)	K, M	N, L, M, J, K
L1Q(1)502125(2)(3)24	1.2	5	0.240 (6.10)	K, M	N, L, M, J, K
L1Q(1)402155(2)(3)12	1.5	4	0.120 (3.05)	K, M	N, L, M, J, K
L1Q(1)502155(2)(3)36	1.5	5	0.360 (9.14)	K, M	N, L, M, J, K
L1Q(1)402185(2)(3)12	1.8	4	0.120 (3.05)	K, M	N, L, M, J, K
L1Q(1)502185(2)(3)36	1.8	5	0.360 (9.14)	K, M	N, L, M, J, K
L1Q(1)402225(2)(3)24	2.2	4	0.240 (6.10)	K, M	N, L, M, J, K
L1Q(1)502225(2)(3)48	2.2	5	0.480 (12.19)	K, M	N, L, M, J, K
L1Q(1)302245(2)(3)12	2.4	3	0.120 (3.05)	K, M	N, L, M, J, K
L1Q(1)502255(2)(3)48	2.5	5	0.480 (12.19)	K, M	N, L, M, J, K
L1Q(1)302275(2)(3)12	2.7	3	0.120 (3.05)	K, M	N, L, M, J, K
L1Q(1)402275(2)(3)24	2.7	4	0.240 (6.10)	K, M	N, L, M, J, K
L1Q(1)502275(2)(3)48	2.7	5	0.480 (12.19)	K, M	N, L, M, J, K
L1Q(1)302335(2)(3)12	3.3	3	0.120 (3.05)	K, M	N, L, M, J, K
L1Q(1)402335(2)(3)24	3.3	4	0.240 (6.10)	K, M	N, L, M, J, K
L1Q(1)502335(2)(3)65	3.3	5	0.650 (16.51)	K, M	N, L, M, J, K
L1Q(1)302365(2)(3)12	3.6	3	0.120 (3.05)	K, M	N, L, M, J, K
L1Q(1)302395(2)(3)12	3.9	3	0.120 (3.05)	K, M	N, L, M, J, K
L1Q(1)402395(2)(3)24	3.9	4	0.240 (6.10)	K, M	N, L, M, J, K
L1Q(1)302475(2)(3)12	4.7	3	0.120 (3.05)	K, M	N, L, M, J, K
L1Q(1)402475(2)(3)36	4.7	4	0.360 (9.14)	K, M	N, L, M, J, K
L1Q(1)302565(2)(3)12	5.6	3	0.120 (3.05)	K, M	N, L, M, J, K
L1Q(1)402565(2)(3)36	5.6	4	0.360 (9.14)	K, M	N, L, M, J, K
L1Q(1)302605(2)(3)12	6	3	0.120 (3.05)	K, M	N, L, M, J, K
L1Q(1)402605(2)(3)36	6	4	0.360 (9.14)	K, M	N, L, M, J, K
L1Q(1)302685(2)(3)24	6.8	3	0.240 (6.10)	K, M	N, L, M, J, K
L1Q(1)402685(2)(3)48	6.8	4	0.480 (12.19)	K, M	N, L, M, J, K
L1Q(1)402755(2)(3)48	7.5	4	0.480 (12.19)	K, M	N, L, M, J, K
L1Q(1)302825(2)(3)24	8.2	3	0.240 (6.10)	K, M	N, L, M, J, K
L1Q(1)402825(2)(3)65	8.2	4	0.650 (16.51)	K, M	N, L, M, J, K
L1Q(1)302106(2)(3)24	10	3	0.240 (6.10)	K, M	N, L, M, J, K
L1Q(1)402106(2)(3)65	10	4	0.650 (16.51)	K, M	N, L, M, J, K
L1Q(1)302116(2)(3)24	11	3	0.240 (6.10)	K, M	N, L, M, J, K
L1Q(1)302126(2)(3)36	12	3	0.360 (9.14)	K, M	N, L, M, J, K
L1Q(1)302156(2)(3)36	15	3	0.360 (9.14)	K, M	N, L, M, J, K
L1Q(1)302166(2)(3)36	16	3	0.360 (9.14)	K, M	N, L, M, J, K
L1Q(1)302186(2)(3)48	18	3	0.480 (12.19)	K, M	N, L, M, J, K
L1Q(1)302206(2)(3)48	20	3	0.480 (12.19)	K, M	N, L, M, J, K
KEMET P/N ¹	Capacitance (μF)	Case Code	Height A inch (mm)	Capacitance Tolerance	Lead Configuration

¹ Complete part number requires additional characters in the numbered positions provided in order to indicate testing option, capacitance tolerance and lead configuration. For each numbered position, available options are as follows:

- (1) Lead style character "N", "L", "M", "J" or "K".
- (2) Capacitance tolerance character "K" or "M".
- (3) Testing option character "S" for Commercial, or "X" for non-standard (customer specific).

Table 1C – Commercial/Non-Standard – Product Selection 200 – 630 VDC cont'd

Commercial/Non-Standard – Customer Specific Unencapsulated, Horizontally Stacked					
KEMET P/N ¹	Capacitance (µF)	Case Code	Height A inch (mm)	Capacitance Tolerance	Lead Configuration
L1Q(1)302226(2)(3)48	22	3	0.480 (12.19)	K, M	N, L, M, J, K
L1Q(1)302276(2)(3)65	27	3	0.650 (16.51)	K, M	N, L, M, J, K
500 VDC – X7R Dielectric					
L1W(1)50C124(2)(3)12	0.12	5	0.120 (3.05)	K, M	N, L, M, J, K
L1W(1)50C154(2)(3)12	0.15	5	0.120 (3.05)	K, M	N, L, M, J, K
L1W(1)50C184(2)(3)12	0.18	5	0.120 (3.05)	K, M	N, L, M, J, K
L1W(1)50C224(2)(3)12	0.22	5	0.120 (3.05)	K, M	N, L, M, J, K
L1W(1)50C274(2)(3)12	0.27	5	0.120 (3.05)	K, M	N, L, M, J, K
L1W(1)50C334(2)(3)24	0.33	5	0.240 (6.10)	K, M	N, L, M, J, K
L1W(1)40C394(2)(3)12	0.39	4	0.120 (3.05)	K, M	N, L, M, J, K
L1W(1)50C394(2)(3)24	0.39	5	0.240 (6.10)	K, M	N, L, M, J, K
L1W(1)40C474(2)(3)12	0.47	4	0.120 (3.05)	K, M	N, L, M, J, K
L1W(1)50C474(2)(3)24	0.47	5	0.240 (6.10)	K, M	N, L, M, J, K
L1W(1)50C564(2)(3)24	0.56	5	0.240 (6.10)	K, M	N, L, M, J, K
L1W(1)40C684(2)(3)12	0.68	4	0.120 (3.05)	K, M	N, L, M, J, K
L1W(1)50C684(2)(3)36	0.68	5	0.360 (9.14)	K, M	N, L, M, J, K
L1W(1)50C754(2)(3)36	0.75	5	0.360 (9.14)	K, M	N, L, M, J, K
L1W(1)40C824(2)(3)12	0.82	4	0.120 (3.05)	K, M	N, L, M, J, K
L1W(1)50C824(2)(3)36	0.82	5	0.360 (9.14)	K, M	N, L, M, J, K
L1W(1)30C105(2)(3)12	1	3	0.120 (3.05)	K, M	N, L, M, J, K
L1W(1)40C105(2)(3)24	1	4	0.240 (6.10)	K, M	N, L, M, J, K
L1W(1)50C105(2)(3)48	1	5	0.480 (12.19)	K, M	N, L, M, J, K
L1W(1)30C125(2)(3)12	1.2	3	0.120 (3.05)	K, M	N, L, M, J, K
L1W(1)40C125(2)(3)24	1.2	4	0.240 (6.10)	K, M	N, L, M, J, K
L1W(1)50C125(2)(3)65	1.2	5	0.650 (16.51)	K, M	N, L, M, J, K
L1W(1)30C155(2)(3)12	1.5	3	0.120 (3.05)	K, M	N, L, M, J, K
L1W(1)40C155(2)(3)24	1.5	4	0.240 (6.10)	K, M	N, L, M, J, K
L1W(1)50C155(2)(3)65	1.5	5	0.650 (16.51)	K, M	N, L, M, J, K
L1W(1)40C185(2)(3)36	1.8	4	0.360 (9.14)	K, M	N, L, M, J, K
L1W(1)30C225(2)(3)12	2.2	3	0.120 (3.05)	K, M	N, L, M, J, K
L1W(1)40C225(2)(3)36	2.2	4	0.360 (9.14)	K, M	N, L, M, J, K
L1W(1)30C245(2)(3)12	2.4	3	0.120 (3.05)	K, M	N, L, M, J, K
L1W(1)30C275(2)(3)12	2.7	3	0.120 (3.05)	K, M	N, L, M, J, K
L1W(1)40C275(2)(3)48	2.7	4	0.480 (12.19)	K, M	N, L, M, J, K
L1W(1)30C335(2)(3)24	3.3	3	0.240 (6.10)	K, M	N, L, M, J, K
L1W(1)40C335(2)(3)48	3.3	4	0.480 (12.19)	K, M	N, L, M, J, K
L1W(1)30C365(2)(3)24	3.6	3	0.240 (6.10)	K, M	N, L, M, J, K
L1W(1)30C395(2)(3)24	3.9	3	0.240 (6.10)	K, M	N, L, M, J, K
L1W(1)40C395(2)(3)65	3.9	4	0.650 (16.51)	K, M	N, L, M, J, K
L1W(1)30C475(2)(3)24	4.7	3	0.240 (6.10)	K, M	N, L, M, J, K
L1W(1)30C565(2)(3)24	5.6	3	0.240 (6.10)	K, M	N, L, M, J, K
L1W(1)30C605(2)(3)24	6	3	0.240 (6.10)	K, M	N, L, M, J, K
L1W(1)30C685(2)(3)36	6.8	3	0.360 (9.14)	K, M	N, L, M, J, K
L1W(1)30C825(2)(3)36	8.2	3	0.360 (9.14)	K, M	N, L, M, J, K
L1W(1)30C106(2)(3)48	10	3	0.480 (12.19)	K, M	N, L, M, J, K
L1W(1)30C116(2)(3)65	11	3	0.650 (16.51)	K, M	N, L, M, J, K
L1W(1)30C126(2)(3)65	12	3	0.650 (16.51)	K, M	N, L, M, J, K
630 VDC – X7R Dielectric					
L1W(1)50B683(2)(3)12	0.068	5	0.120 (3.05)	K, M	N, L, M, J, K
L1W(1)40B104(2)(3)12	0.1	4	0.120 (3.05)	K, M	N, L, M, J, K
L1W(1)50B104(2)(3)12	0.1	5	0.120 (3.05)	K, M	N, L, M, J, K
L1W(1)50B124(2)(3)12	0.12	5	0.120 (3.05)	K, M	N, L, M, J, K
KEMET P/N ¹	Capacitance (µF)	Case Code	Height A inch (mm)	Capacitance Tolerance	Lead Configuration

¹ Complete part number requires additional characters in the numbered positions provided in order to indicate testing option, capacitance tolerance and lead configuration. For each numbered position, available options are as follows:

- (1) Lead style character "N", "L", "M", "J" or "K".
- (2) Capacitance tolerance character "K" or "M".
- (3) Testing option character "S" for Commercial, or "X" for non-standard (customer specific).

Table 1C – Commercial/Non-Standard – Product Selection 630 – 1,000 VDC cont'd

Commercial/Non-Standard – Customer Specific Unencapsulated, Horizontally Stacked					
KEMET P/N ¹	Capacitance (µF)	Case Code	Height A inch (mm)	Capacitance Tolerance	Lead Configuration
L1W(1)50B154(2)(3)12	0.15	5	0.120 (3.05)	K, M	N, L, M, J, K
L1W(1)50B184(2)(3)24	0.18	5	0.240 (6.10)	K, M	N, L, M, J, K
L1W(1)30B224(2)(3)12	0.22	3	0.120 (3.05)	K, M	N, L, M, J, K
L1W(1)40B224(2)(3)12	0.22	4	0.120 (3.05)	K, M	N, L, M, J, K
L1W(1)50B224(2)(3)24	0.22	5	0.240 (6.10)	K, M	N, L, M, J, K
L1W(1)50B274(2)(3)24	0.27	5	0.240 (6.10)	K, M	N, L, M, J, K
L1W(1)30B334(2)(3)12	0.33	3	0.120 (3.05)	K, M	N, L, M, J, K
L1W(1)50B334(2)(3)36	0.33	5	0.360 (9.14)	K, M	N, L, M, J, K
L1W(1)40B394(2)(3)12	0.39	4	0.120 (3.05)	K, M	N, L, M, J, K
L1W(1)50B394(2)(3)36	0.39	5	0.360 (9.14)	K, M	N, L, M, J, K
L1W(1)30B474(2)(3)12	0.47	3	0.120 (3.05)	K, M	N, L, M, J, K
L1W(1)40B474(2)(3)24	0.47	4	0.240 (6.10)	K, M	N, L, M, J, K
L1W(1)50B474(2)(3)36	0.47	5	0.360 (9.14)	K, M	N, L, M, J, K
L1W(1)50B564(2)(3)48	0.56	5	0.480 (12.19)	K, M	N, L, M, J, K
L1W(1)30B684(2)(3)12	0.68	3	0.120 (3.05)	K, M	N, L, M, J, K
L1W(1)40B684(2)(3)24	0.68	4	0.240 (6.10)	K, M	N, L, M, J, K
L1W(1)50B684(2)(3)65	0.68	5	0.650 (16.51)	K, M	N, L, M, J, K
L1W(1)50B754(2)(3)65	0.75	5	0.650 (16.51)	K, M	N, L, M, J, K
L1W(1)40B824(2)(3)24	0.82	4	0.240 (6.10)	K, M	N, L, M, J, K
L1W(1)30B105(2)(3)12	1	3	0.120 (3.05)	K, M	N, L, M, J, K
L1W(1)40B105(2)(3)36	1	4	0.360 (9.14)	K, M	N, L, M, J, K
L1W(1)30B125(2)(3)12	1.2	3	0.120 (3.05)	K, M	N, L, M, J, K
L1W(1)40B125(2)(3)36	1.2	4	0.360 (9.14)	K, M	N, L, M, J, K
L1W(1)30B155(2)(3)12	1.5	3	0.120 (3.05)	K, M	N, L, M, J, K
L1W(1)40B155(2)(3)48	1.5	4	0.480 (12.19)	K, M	N, L, M, J, K
L1W(1)40B185(2)(3)48	1.8	4	0.480 (12.19)	K, M	N, L, M, J, K
L1W(1)30B225(2)(3)24	2.2	3	0.240 (6.10)	K, M	N, L, M, J, K
L1W(1)40B225(2)(3)65	2.2	4	0.650 (16.51)	K, M	N, L, M, J, K
L1W(1)30B245(2)(3)24	2.4	3	0.240 (6.10)	K, M	N, L, M, J, K
L1W(1)30B275(2)(3)24	2.7	3	0.240 (6.10)	K, M	N, L, M, J, K
L1W(1)30B335(2)(3)36	3.3	3	0.360 (9.14)	K, M	N, L, M, J, K
L1W(1)30B365(2)(3)36	3.6	3	0.360 (9.14)	K, M	N, L, M, J, K
L1W(1)30B395(2)(3)36	3.9	3	0.360 (9.14)	K, M	N, L, M, J, K
L1W(1)30B475(2)(3)36	4.7	3	0.360 (9.14)	K, M	N, L, M, J, K
L1W(1)30B565(2)(3)48	5.6	3	0.480 (12.19)	K, M	N, L, M, J, K
L1W(1)30B605(2)(3)65	6	3	0.650 (16.51)	K, M	N, L, M, J, K
L1W(1)30B685(2)(3)65	6.8	3	0.650 (16.51)	K, M	N, L, M, J, K
1,000 VDC – X7R Dielectric					
L1W(1)50D473(2)(3)12	0.047	5	0.120 (3.05)	K, M	N, L, M, J, K
L1W(1)50D683(2)(3)12	0.068	5	0.120 (3.05)	K, M	N, L, M, J, K
L1W(1)30D104(2)(3)12	0.1	3	0.120 (3.05)	K, M	N, L, M, J, K
L1W(1)40D104(2)(3)12	0.1	4	0.120 (3.05)	K, M	N, L, M, J, K
L1W(1)50D104(2)(3)24	0.1	5	0.240 (6.10)	K, M	N, L, M, J, K
L1W(1)50D124(2)(3)24	0.12	5	0.240 (6.10)	K, M	N, L, M, J, K
L1W(1)50D154(2)(3)36	0.15	5	0.360 (9.14)	K, M	N, L, M, J, K
L1W(1)50D184(2)(3)36	0.18	5	0.360 (9.14)	K, M	N, L, M, J, K
L1W(1)30D224(2)(3)12	0.22	3	0.120 (3.05)	K, M	N, L, M, J, K
L1W(1)40D224(2)(3)12	0.22	4	0.120 (3.05)	K, M	N, L, M, J, K
L1W(1)50D224(2)(3)36	0.22	5	0.360 (9.14)	K, M	N, L, M, J, K
L1W(1)50D274(2)(3)48	0.27	5	0.480 (12.19)	K, M	N, L, M, J, K
L1W(1)30D334(2)(3)12	0.33	3	0.120 (3.05)	K, M	N, L, M, J, K
L1W(1)50D334(2)(3)65	0.33	5	0.650 (16.51)	K, M	N, L, M, J, K
L1W(1)40D394(2)(3)24	0.39	4	0.240 (6.10)	K, M	N, L, M, J, K
KEMET P/N ¹	Capacitance (µF)	Case Code	Height A inch (mm)	Capacitance Tolerance	Lead Configuration

¹ Complete part number requires additional characters in the numbered positions provided in order to indicate testing option, capacitance tolerance and lead configuration. For each numbered position, available options are as follows:

- (1) Lead style character "N", "L", "M", "J" or "K".
- (2) Capacitance tolerance character "K" or "M".
- (3) Testing option character "S" for Commercial, or "X" for non-standard (customer specific).

Table 1C – Commercial/Non-Standard – Product Selection 1,000 VDC cont'd

Commercial/Non-Standard – Customer Specific Unencapsulated, Horizontally Stacked					
KEMET P/N ¹	Capacitance (μF)	Case Code	Height A inch (mm)	Capacitance Tolerance	Lead Configuration
L1W(1)50D394(2)(3)65	0.39	5	0.650 (16.51)	K, M	N, L, M, J, K
L1W(1)30D474(2)(3)12	0.47	3	0.120 (3.05)	K, M	N, L, M, J, K
L1W(1)40D474(2)(3)24	0.47	4	0.240 (6.10)	K, M	N, L, M, J, K
L1W(1)30D684(2)(3)12	0.68	3	0.120 (3.05)	K, M	N, L, M, J, K
L1W(1)40D684(2)(3)36	0.68	4	0.360 (9.14)	K, M	N, L, M, J, K
L1W(1)40D824(2)(3)48	0.82	4	0.480 (12.19)	K, M	N, L, M, J, K
L1W(1)30D105(2)(3)24	1	3	0.240 (6.10)	K, M	N, L, M, J, K
L1W(1)40D105(2)(3)65	1	4	0.650 (16.51)	K, M	N, L, M, J, K
L1W(1)30D125(2)(3)24	1.2	3	0.240 (6.10)	K, M	N, L, M, J, K
L1W(1)30D155(2)(3)36	1.5	3	0.360 (9.14)	K, M	N, L, M, J, K
L1W(1)30D225(2)(3)36	2.2	3	0.360 (9.14)	K, M	N, L, M, J, K
L1W(1)30D245(2)(3)48	2.4	3	0.480 (12.19)	K, M	N, L, M, J, K
L1W(1)30D275(2)(3)48	2.7	3	0.480 (12.19)	K, M	N, L, M, J, K
L1W(1)30D335(2)(3)65	3.3	3	0.650 (16.51)	K, M	N, L, M, J, K
KEMET P/N ¹	Capacitance (μF)	Case Code	Height A inch (mm)	Capacitance Tolerance	Lead Configuration

¹ Complete part number requires additional characters in the numbered positions provided in order to indicate testing option, capacitance tolerance and lead configuration. For each numbered position, available options are as follows:

- (1) Lead style character "N", "L", "M", "J" or "K".
- (2) Capacitance tolerance character "K" or "M".
- (3) Testing option character "S" for Commercial, or "X" for non-standard (customer specific).

L1	R	N	30	C	106	K	S	12	
Product Family	Dielectric Classification/Characteristic	Lead Configuration	Case Size/Case Code (CC)	Rated Voltage (VDC)	Capacitance Code (pF)	Capacitance Tolerance	Testing Option	Maximum Height Dimension (in.)	
L1 = Unencapsulated L2 = Encapsulated	Q = BQ R = BR X = BX W = X7R	N = Straight L = Formed "L" M = Formed "L" J = Formed "J" K = Formed "J"	30 = CC 3 40 = CC 4 50 = CC 5	3 = 25 5 = 50 1 = 100 2 = 200 C = 500 B = 630 D = 1,000	2 Sig. Digits + Number of Zeros	J = ±5% K = ±10% M = ±20%	B = M49470 "B" Level T = M49470 "T" Level C = DSCC87106 S = Commercial X = Non-Standard (Customer Specific Requirements)	Unencapsulated 12 = 0.12" 24 = 0.24" 36 = 0.36" 48 = 0.48" 65 = 0.65"	Encapsulated 27 = 0.27" 39 = 0.39" 53 = 0.53" 66 = 0.66" 80 = 0.80"

Soldering Process

The capacitors and assemblies outlined in this specification sheet are susceptible to thermal shock damage due to their large ceramic mass. Temperature profiles used should provide adequate temperature rise and cool-down time to prevent damage from thermal shock. In general, KEMET recommends against hand soldering for these types of large ceramic devices.

Recommended Soldering Technique:

- Solder reflow only

Recommended Reflow Soldering Profile:

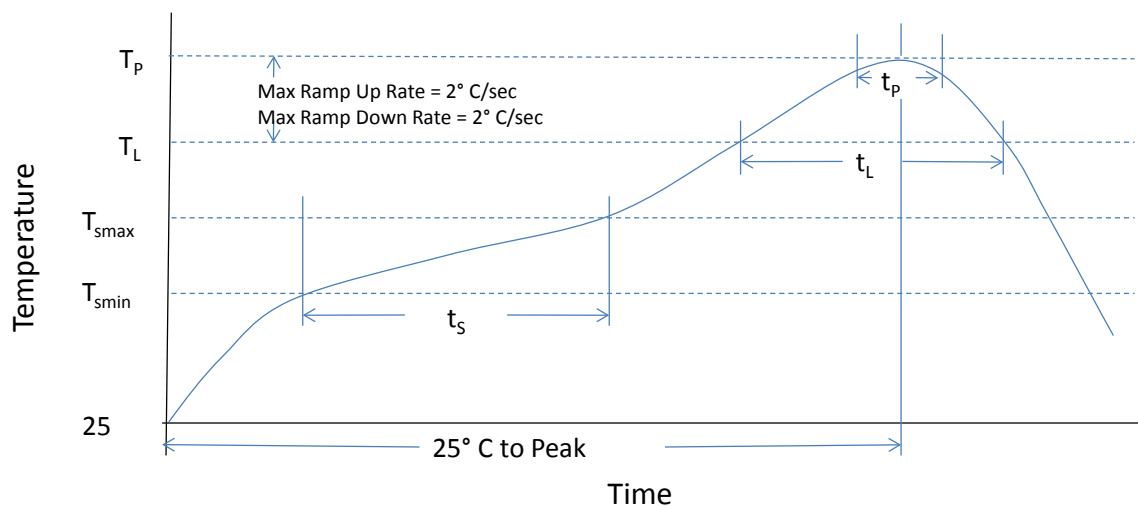

Profile Feature	Sn-Pb Assembly
Preheat/Soak	
Temperature Minimum (T_{Smin})	100°C
Temperature Maximum (T_{Smax})	150°C
Time (t_s) from T_{Smin} to T_{Smax}	60-90 seconds
Ramp-up rate (T_L to T_P)	2°C/seconds
Liquidous temperature (T_L)	183°C
Time above liquidous (t_L)	95 seconds
Peak Temperature (T_P)	240°C
Time within 5°C of maximum peak temperature (t_p)	5 seconds
Ramp-down rate (T_P to T_L)	2°C/seconds
Time 25° C to peak temperature	3.5 minutes

Note 1: All temperatures refer to the center of the package, measured on the package body surface that is facing up during assembly reflow

Preheating and Reflow Profile Notes:

Due to differences in the coefficient of thermal expansion for the different materials of construction, it is critical to monitor and control the heating and cooling rates during the soldering process. During the reflow soldering process, the maximum recommended heating and cooling rate (dT/dt) is 4°C/second. To ensure optimal component reliability, KEMET's recommended heating and cooling rate is 2°C/second. After soldering, the capacitors should be air cooled to room temperature before further processing. Forced air cooling is not recommended.

Table 4 – Performance & Reliability: Test Methods and Conditions

Inspection	Test Method	Test Level Option				
		MIL-PRF-49470 B Level (B)	MIL-PRF-49470 T Level (T)	DSSC Drawing 87106 (C) ¹	Commercial (S)	Non-Standard (X) ²
In-Process Inspection						
Ultrasonic Scanning (C-SAM)	Meet EIA-469 Criteria	Not required	Yes (per lot)	Not required	Not required	Optional per Source Controlled Drawing (SCD)
DPA Analysis	EIA-469					
In-Process Visual Inspection	MIL-PRF-49470 Method 4.8.3					
Group A Requirements						
Thermal Shock	MIL-STD-202 Method 107	Yes (5 cycles)	Yes (20 cycles)	Yes (5 cycles)	Not required	Optional per Source Controlled Drawing (SCD)
Voltage Conditioning ≤ 200 V 500 V	MIL-PRF-49470 Method 4.8.5.2 200%V _R @125°C 120%V _R @125°C	Yes (96 hours minimum)	Yes (168 hours minimum)	Yes (96 hours minimum)		
Visual and Mechanical Inspection	MIL-PRF-49470 Method 4.8.4	Yes (per lot)	Yes (per lot)	Yes (per lot)		Yes (per lot)
Solderability	MIL-STD-202 Method 208	Yes (per Inspection lot)		Yes (per inspection lot)		Optional per Source Controlled Drawing (SCD)
DPA Analysis	EIA-469	Not required		Not required		
Group B Requirements						
Voltage-Temperature Limits (TCVC)	MIL-PRF-49470 Method 4.8.13.2	Yes (periodic)	Yes (per lot)	Yes (periodic)	Not required	Optional per Source Controlled Drawing (SCD)
Resistance to Solvents	MIL-STD-202 Method 215					
Terminal Strength	MIL-STD-202 Method 211					
Resistance to Soldering Heat	MIL-STD-202 Method 210					
Moisture Resistance	MIL-STD-202 Method 106					
Marking Legibility	MIL-PRF-49470 Method 4.8.4.1	Not required	Yes (per lot)	Yes (periodic)		
Low Voltage Humidity Testing	MIL-STD-202 Method 103					
Life Test ≤ 200 V 500 V	MIL-STD-202 Method 108 200%V _R @125°C 120%V _R @125°C					
Thermal Shock	MIL-STD-202 Method 107	Not required	Not required	Not required		
KEMET Requirements						
Visual and Mechanical Inspection (100%)	KEMET Standard	Yes	Yes	Yes	Yes	Yes
Voltage Conditioning						

¹ As per discretionary statement outlined in cancelled DSSC Drawing 87106, KEMET will not perform Group B inspections on a per lot basis. KEMET 87106 orders may include a standard certificate of compliance stating compliance to the 87106 requirements, specifically conformance to Group B inspections. Please contact KEMET for additional details

² Non-standard test level option is designated to satisfy customer specific testing requirements that may deviate from those stated in a Mil-Spec or DSSC drawing.

Product Marking

Capacitors shall be marked with KEMET's name, trademark or (CAGE) code, date, capacitance and capacitance tolerance codes. The date code shall consist of the year and week. For example, the third week of 2011 would be 1103 using a 4-digit date code or 103 using a 3-digit date code. At the option of the manufacturer, the date code may be placed on a separate line. Full marking shall be included on the package.

JT
12345
106K
1103

Case code 4 or 5 example

MIL-PRF-49470

Capacitor marking will include "JAN" or "J."

Case codes 4 and 5 shall be marked with the following sequence of information:

J brand (1 digit), product level designator ("B" or "T")

Manufacturer's identification (1 to 5 digits)

Capacitance code (3 digits) and capacitance tolerance (1 digit)

Date code (3 or 4 digits)

Case code 3 shall either be fully marked or partially marked like case code 4 or 5 parts at the option of KEMET.

DSCC 87106

Marking shall be in accordance with MIL-STD-1285, except the parts shall be marked with the part number as specified in paragraph 1.2 of DSCC Drawing 87106 with the manufacturer's name or code and date code minimum. Case sizes 4 and 5 shall be marked with coded capacitance and tolerance minimum. Full marking shall be included on the package.

Storage and Handling

Ceramic chip capacitors should be stored in normal working environments. While the chips themselves are quite robust in other environments, solderability will be degraded by exposure to high temperatures, high humidity, corrosive atmospheres, and long term storage. In addition, packaging materials will be degraded by high temperature– reels may soften or warp and tape peel force may increase. KEMET recommends that maximum storage temperature not exceed 40°C and maximum storage humidity not exceed 70% relative humidity. Temperature fluctuations should be minimized to avoid condensation on the parts and atmospheres should be free of chlorine and sulfur bearing compounds. For optimized solderability chip stock should be used promptly, preferably within 1.5 years of receipt.

Packaging

Shipping Container Packaging Quantities		
Case Code	Small Box Quantity ¹ (7.5" x 7.5")	Large Box Quantity ¹ (13.0" x 13.0")
3	28	104
4	36	144
5	64	225

¹ Minimum order value applies. Contact KEMET for details.

Application Notes

Notice of KEMET MIL-PRF-49470 Qualified Products Listing (QPL) Status.

KEMET is qualified to supply MIL-PRF-49470/1 unencapsulated X7R Case Codes 3, 4, & 5 ceramic SMPS capacitors in DC voltage ratings of 50 V, 100 V, 200 V, and 500 V. This qualification includes both "B" and "T" test levels.

KEMET is also qualified to supply MIL-PRF-49470/2 encapsulated X7R Case Codes 3, 4, & 5 ceramic SMPS capacitors in DC voltage ratings of 50 V, 100 V, 200 V, and 500 V. This qualification includes "B" level testing only.

Notice of Cancellation: DSCC Drawing 87106 was cancelled on January 3rd 2005. MIL-PRF-49470 parts are preferred and direct replacements.

MIL-PRF-49470 capacitors are preferred over DSCC 87106 capacitors. The MIL-PRF-49470 specification was developed as part of a cooperative effort between the U.S. Military, NASA and the switch mode power supply capacitor manufacturers to produce a robust direct replacement for the DSCC drawing. The military specification product provides additional quality assurance provisions that are NOT required by the DSCC drawing. Two product levels are offered in MIL-PRF-49470: the standard "B" level and the high reliability "T" level. Some of the benefits of the MIL-PRF-49470 product over the 87106 product include the following: Formal qualification process (QPL established), MIL-STD-790 compliance, DSCC audits, routine qualification maintenance testing, i.e., life testing, group A percent defective allowed (PDA) specified, and prohibiting the mixing of chips from different production lots within a single SMPS capacitor stack lot.

MIL-PRF-49470 "T" Level product is recommended for all high reliability applications. MIL-PRF-49470 "T" level product requires the following in-process inspections and additional group A and B screening inspections that are not part of the normal "B" level flow: In-process screening that includes non-destructive internal examination (chip level) and destructive physical analysis (chip level), group A destructive physical analysis (finished stack level), group B lot specific humidity, steady-state, low voltage (lot sample test), and group B lot specific thermal shock and life test (lot sample test).

For additional information regarding KEMET MIL-PRF-49470 QPL status or cancellation of DSCC Drawing 87106, please visit the DSCC website at: www.dscc.dla.mil.

High Temperature 150°C, Ultra-Stable X8R Dielectric, 25 – 100 VDC (Commercial & Automotive Grade)

Overview

KEMET's Ultra-Stable X8R dielectric features a 150°C maximum operating temperature, offering the latest in high temperature dielectric technology and reliability for extreme temperature applications. It offers the same temperature capability as conventional X8R, but without the capacitance loss due to applied DC voltage. Ultra-Stable X8R exhibits no change in capacitance with respect to voltage and boasts a minimal change in capacitance with reference to ambient temperature. It is a suitable replacement for higher capacitance and larger footprint devices that fail to offer capacitance stability. Capacitance change with respect to temperature is limited to $\pm 15\%$ from -55°C to +150°C.

Driven by the demand for a more robust and reliable component, Ultra-Stable X8R dielectric capacitors were developed for critical applications where reliability and capacitance stability at higher operating temperatures are a concern. These capacitors are widely used in automotive circuits as well as general high temperature applications.

In addition to commercial grade, automotive grade devices are available and meet the demanding Automotive Electronics Council's AEC-Q200 qualification requirements.

Benefits

- -55°C to +150°C operating temperature range
- Pb-Free and RoHS Compliant
- EIA 0402, 0603, 0805, 1206, 1210, and 1812 case sizes
- DC voltage ratings of 25 V, 50 V, and 100 V
- Capacitance offerings ranging from 10 pF to 0.22 μ F
- Available capacitance tolerances of $\pm 1\%$, $\pm 2\%$, $\pm 5\%$, $\pm 10\%$, and $\pm 20\%$
- Extremely low ESR and ESL
- High thermal stability
- High ripple current capability
- No capacitance change with respect to applied rated DC voltage
- Non-polar device, minimizing installation concerns
- Offered in both commercial and automotive grades
- 100% pure matte tin-plated termination finish that allowing for excellent solderability.
- SnPb plated termination finish option available upon request (5% minimum)

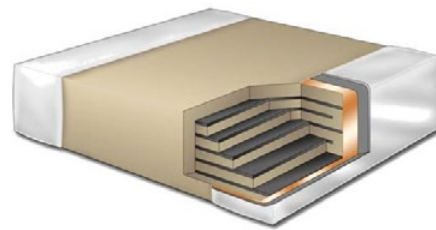

Ordering Information

C	1210	C	184	K	3	H	A	C	AUTO
Ceramic	Case Size (L" x W")	Specification/ Series ¹	Capacitance Code (pF)	Capacitance Tolerance	Voltage	Dielectric	Failure Rate/ Design	Termination Finish ²	Packaging/Grade (C-Spec) ²
	0402 0603 0805 1206 1210 1812	C = Standard	2 Significant Digits + Number of Zeros	F = $\pm 1\%$ G = $\pm 2\%$ J = $\pm 5\%$ K = $\pm 10\%$ M = $\pm 20\%$	3 = 25 V 5 = 50 V 1 = 100 V	H = Ultra Stable X8R	A = N/A	C = 100% Matte Sn L = SnPb (5% minimum)	Blank = Bulk TU = 7" Reel Unmarked AUTO = Automotive Grade 7" Reel Unmarked

¹ Flexible termination option is available. Please see FT-CAP product bulletin C1013_X8R_FT-CAP_SMD

² Additional termination finish options may be available. Contact KEMET for details.

^{2,3} SnPb termination finish option is not available on automotive grade product.

³ Additional reeling or packaging options may be available. Contact KEMET for details.

Dimensions – Millimeters (Inches)

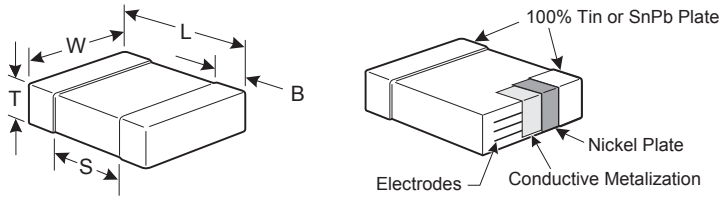

EIA Size Code	Metric Size Code	L Length	W Width	T Thickness	B Bandwidth	S Separation Minimum	Mounting Technique
0402	1005	1.00 (.040) ± 0.05 (.002)	0.50 (.020) ± 0.05 (.002)	See Table 2 for Thickness	0.30 (.012) ± 0.10 (.004)	0.30 (.012)	Solder Reflow Only
0603	1608	1.60 (.063) ± 0.15 (.006)	0.80 (.032) ± 0.15 (.006)		0.35 (.014) ± 0.15 (.006)	0.70 (.028)	Solder Wave or Solder Reflow
0805	2012	2.00 (.079) ± 0.20 (.008)	1.25 (.049) ± 0.20 (.008)		0.50 (0.02) ± 0.25 (.010)	0.75 (.030)	
1206	3216	3.20 (.126) ± 0.20 (.008)	1.60 (.063) ± 0.20 (.008)		0.50 (0.02) ± 0.25 (.010)	N/A	Solder Reflow Only
1210	3225	3.20 (.126) ± 0.20 (.008)	2.50 (.098) ± 0.20 (.008)		0.50 (0.02) ± 0.25 (.010)		
1812	4532	4.50 (.177) ± 0.30 (.012)	3.20 (.126) ± 0.30 (.012)		0.60 (.024) ± 0.35 (.014)		

Applications

Typical applications include decoupling, bypass and filtering in extreme environments such as down-hole oil exploration, under-hood automotive, military and aerospace.

Qualification/Certification

Commercial Grade products are subject to internal qualification. Details regarding test methods and conditions are referenced in Table 4, Performance & Reliability.

Automotive Grade products meet or exceed the requirements outlined by the Automotive Electronics Council. Details regarding test methods and conditions are referenced in document AEC-Q200, Stress Test Qualification for Passive Components. For additional information regarding the Automotive Electronics Council and AEC-Q200, please visit their website at www.aecouncil.com.

Environmental Compliance

Pb-Free and RoHS Compliant (excluding SnPb termination finish option).



RoHS Compliant

Electrical Parameters/Characteristics

Item	Parameters/Characteristics
Operating Temperature Range	-55°C to +150°C
Capacitance Change with Reference to +25°C and 0 VDC Applied (TCC)	±15%
Aging Rate (Maximum % Capacitance Loss/Decade Hour)	0%
Dielectric Withstanding Voltage (DWV)	250% of rated voltage (5 ±1 seconds and charge/discharge not exceeding 50 mA)
Dissipation Factor (DF) Maximum Limit @ 25°C	2.5%
Insulation Resistance (IR) Limit @ 25°C	1,000 megohm microfarads or 100 GΩ (Rated voltage applied for 120 ±5 seconds @ 25°C)

To obtain IR limit, divide $M\Omega\text{-}\mu F$ value by the capacitance and compare to $G\Omega$ limit. Select the lower of the two limits.

Capacitance and dissipation factor (DF) measured under the following conditions:

1 MHz ±100 kHz and 1.0 ±0.2 Vrms if capacitance ≤ 1,000 pF.

1 kHz ±50 Hz and 1.0 ±0.2 Vrms if capacitance > 1,000 pF

Note: When measuring capacitance it is important to ensure the set voltage level is held constant. The HP4284 and Agilent E4980 have a feature known as Automatic Level Control (ALC). The ALC feature should be switched to "ON."

Post Environmental Limits

High Temperature Life, Biased Humidity, Moisture Resistance					
Dielectric	Rated DC Voltage	Capacitance Value	Dissipation Factor (Maximum %)	Capacitance Shift	Insulation Resistance
Ultra-Stable X8R	All	All	2.5	0.3% or ±0.25 pf	10% of Initial Limit

Table 1 – Capacitance Range/Selection Waterfall (0402 – 1812 Case Sizes)

Capacitance	Cap Code	Case Size / Series					C0402C			C0603C			C0805C			C1206C			C1210C			C1812C		
		Voltage Code					3	5	1	3	5	1	3	5	1	3	5	1	3	5	1	5	1	
		Rated Voltage (VDC)					25	50	100	25	50	100	25	50	100	25	50	100	25	50	100	50	100	
		Capacitance Tolerance					Product Availability and Chip Thickness Codes See Table 2 for Chip Thickness Dimensions																	
100 pF	101	F	G	J	K	M	BB	BB	BB															
110 pF	111	F	G	J	K	M	BB	BB	BB															
120 pF	121	F	G	J	K	M	BB	BB	BB															
130 pF	131	F	G	J	K	M	BB	BB	BB															
150 pF	151	F	G	J	K	M	BB	BB	BB															
160 pF	161	F	G	J	K	M	BB	BB	BB															
180 pF	181	F	G	J	K	M	BB	BB	BB															
200 pF	201	F	G	J	K	M	BB	BB	BB															
220 pF	221	F	G	J	K	M	BB	BB	BB															
240 pF	241	F	G	J	K	M	BB	BB	BB															
270 pF	271	F	G	J	K	M	BB	BB	BB															
300 pF	301	F	G	J	K	M	BB	BB	BB															
330 pF	331	F	G	J	K	M	BB	BB	BB															
360 pF	361	F	G	J	K	M	BB	BB	BB															
390 pF	391	F	G	J	K	M	BB	BB	BB															
430 pF	431	F	G	J	K	M	BB	BB	BB	CB	CB	CB												
470 pF	471	F	G	J	K	M	BB	BB	BB	CB	CB	CB												
510 pF	511	F	G	J	K	M	BB	BB	BB	CB	CB	CB												
560 pF	561	F	G	J	K	M	BB	BB	BB	CB	CB	CB												
620 pF	621	F	G	J	K	M	BB	BB	BB	CB	CB	CB												
680 pF	681	F	G	J	K	M	BB	BB	BB	CB	CB	CB												
750 pF	751	F	G	J	K	M	BB	BB	BB	CB	CB	CB												
820 pF	821	F	G	J	K	M	BB	BB	BB	CB	CB	CB												
910 pF	911	F	G	J	K	M	BB	BB	BB	CB	CB	CB												
1,000 pF	102	F	G	J	K	M	BB	BB	BB	CB	CB	CB												
1,100 pF	112	F	G	J	K	M	BB	BB		CB	CB	CB												
1,200 pF	122	F	G	J	K	M	BB	BB		CB	CB	CB												
1,300 pF	132	F	G	J	K	M	BB	BB		CB	CB	CB												
1,500 pF	152	F	G	J	K	M	BB	BB		CB	CB	CB												
1,600 pF	162	F	G	J	K	M				CB	CB	CB												
1,800 pF	182	F	G	J	K	M				CB	CB	CB												
2,000 pF	202	F	G	J	K	M				CB	CB	CB	DC	DC	DC									
2,200 pF	222	F	G	J	K	M				CB	CB	CB	DC	DC	DC									
2,400 pF	242	F	G	J	K	M				CB	CB	CB	DC	DC	DC									
2,700 pF	272	F	G	J	K	M				CB	CB	CB	DC	DC	DC									
3,000 pF	302	F	G	J	K	M				CB	CB	CB	DC	DC	DC									
3,300 pF	332	F	G	J	K	M				CB	CB	CB	DC	DC	DC									
3,600 pF	362	F	G	J	K	M				CB	CB	CB	DC	DC	DC									
3,900 pF	392	F	G	J	K	M				CB	CB	CB	DC	DC	DC									
4,300 pF	432	F	G	J	K	M				CB	CB	CB	DC	DC	DC									
4,700 pF	472	F	G	J	K	M				CB	CB	CB	DC	DC	DC									
5,100 pF	512	F	G	J	K	M				CB	CB	CB	DC	DC	DC									
5,600 pF	562	F	G	J	K	M				CB	CB	CB	DC	DC	DC									
6,200 pF	622	F	G	J	K	M				CB	CB	CB	DC	DC	DC									
6,800 pF	682	F	G	J	K	M				CB	CB	CB	DC	DC	DC	EB	EB	EB						
7,500 pF	752	F	G	J	K	M				CB	CB	CB	DC	DC	DC	EB	EB	EB						
8,200 pF	822	F	G	J	K	M				CB	CB	CB	DC	DC	DC	EB	EB	EB						
9,100 pF	912	F	G	J	K	M				CB	CB	CB	DC	DC	DC	EB	EB	EB						
10,000 pF	103	F	G	J	K	M				CB	CB	CB	DC	DC	DD	EB	EB	EB						
12,000 pF	123	F	G	J	K	M							DC	DC	DE	EB	EB	EB	FB	FB	FB			
15,000 pF	153	F	G	J	K	M							DC	DD	DG	EB	EB	EB	EB	FB	FB	FB	GB	GB
18,000 pF	183	F	G	J	K	M							DC	DD		EB	EB	EB	FB	FB	FB	GB	GB	
22,000 pF	223	F	G	J	K	M							DD	DF		EB	EB	EC	FB	FB	FB	GB	GB	
27,000 pF	273	F	G	J	K	M							DF			EB	EB	EE	FB	FB	FB	GB	GB	
33,000 pF	333	F	G	J	K	M							DG			EB	EB	EE	FB	FB	FB	GB	GB	
Capacitance	Cap Code	Rated Voltage (VDC)					25	50	100	25	50	100	25	50	100	25	50	100	25	50	100	50	100	
		Voltage Code					3	5	1	3	5	1	3	5	1	3	5	1	3	5	1	5	1	
		Case Size / Series					C0402C			C0603C			C0805C			C1206C			C1210C			C1812C		

Table 1 – Capacitance Range/Selection Waterfall (0402 – 1812 Case Sizes) cont'd

Capacitance	Cap Code	Case Size / Series	C0402C			C0603C			C0805C			C1206C			C1210C			C1812C	
		Voltage Code	3	5	1	3	5	1	3	5	1	3	5	1	3	5	1	5	1
		Rated Voltage (VDC)	25	50	100	25	50	100	25	50	100	25	50	100	25	50	100	50	100
		Capacitance Tolerance	Product Availability and Chip Thickness Codes See Table 2 for Chip Thickness Dimensions																
47,000 pF	473	F G J K M										EC	EE	EH	FB	FB	FE	GB	GB
56,000 pF	563	F G J K M										ED	EF	EH	FB	FB	FF	GB	GB
68,000 pF	683	F G J K M										EF	EH		FB	FC	FG	GB	GB
82,000 pF	823	F G J K M										EH	EH		FC	FF	FH	GB	GB
100,000 pF	104	F G J K M										EH			FE	FG	FM	GB	GD
120,000 pF	124	F G J K M													FG	FH		GB	GH
150,000 pF	154	F G J K M													FH	FM		GD	GN
180,000 pF	184	F G J K M													FJ			GH	
220,000 pF	224	F G J K M																GK	
Capacitance	Cap Code	Rated Voltage (VDC)	25	50	100	25	50	100	25	50	100	25	50	100	25	50	100	50	100
		Voltage Code	3	5	1	3	5	1	3	5	1	3	5	1	3	5	1	5	1
		Case Size / Series	C0402C			C0603C			C0805C			C1206C			C1210C			C1812C	

Table 2 – Chip Thickness/Packaging Quantities

Thickness Code	Case Size	Thickness ± Range (mm)	Paper Quantity		Plastic Quantity	
			7" Reel	13" Reel	7" Reel	13" Reel
BB	0402	0.50 ± 0.05	10,000	50,000	0	0
CB	0603	0.80 ± 0.07	4,000	10,000	0	0
DC	0805	0.78 ± 0.10	4,000	10,000	0	0
DD	0805	0.90 ± 0.10	4,000	10,000	0	0
DE	0805	1.00 ± 0.10	0	0	2,500	10,000
DF	0805	1.10 ± 0.10	0	0	2,500	10,000
DG	0805	1.25 ± 0.15	0	0	2,500	10,000
EB	1206	0.78 ± 0.10	4,000	10,000	4,000	10,000
EC	1206	0.90 ± 0.10	0	0	4,000	10,000
ED	1206	1.00 ± 0.10	0	0	2,500	10,000
EE	1206	1.10 ± 0.10	0	0	2,500	10,000
EF	1206	1.20 ± 0.15	0	0	2,500	10,000
EH	1206	1.60 ± 0.20	0	0	2,000	8,000
FB	1210	0.78 ± 0.10	0	0	4,000	10,000
FC	1210	0.90 ± 0.10	0	0	4,000	10,000
FE	1210	1.00 ± 0.10	0	0	2,500	10,000
FF	1210	1.10 ± 0.10	0	0	2,500	10,000
FG	1210	1.25 ± 0.15	0	0	2,500	10,000
FH	1210	1.55 ± 0.15	0	0	2,000	8,000
FM	1210	1.70 ± 0.20	0	0	2,000	8,000
FJ	1210	1.85 ± 0.20	0	0	2,000	8,000
GB	1812	1.00 ± 0.10	0	0	1,000	4,000
GD	1812	1.25 ± 0.15	0	0	1,000	4,000
GH	1812	1.40 ± 0.15	0	0	1,000	4,000
GK	1812	1.60 ± 0.20	0	0	1,000	4,000
GN	1812	1.70 ± 0.20	0	0	1,000	4,000
Thickness Code	Case Size	Thickness ± Range (mm)	7" Reel	13" Reel	7" Reel	13" Reel
			Paper Quantity		Plastic Quantity	

Packaging quantity based on finished chip thickness specifications.

Table 3 – Chip Capacitor Land Pattern Design Recommendations per IPC–7351

EIA Size Code	Metric Size Code	Density Level A: Maximum (Most) Land Protrusion (mm)					Density Level B: Median (Nominal) Land Protrusion (mm)					Density Level C: Minimum (Least) Land Protrusion (mm)				
		C	Y	X	V1	V2	C	Y	X	V1	V2	C	Y	X	V1	V2
0402	1005	0.50	0.72	0.72	2.20	1.20	0.45	0.62	0.62	1.90	1.00	0.40	0.52	0.52	1.60	0.80
0603	1608	0.90	1.15	1.10	4.00	2.10	0.80	0.95	1.00	3.10	1.50	0.60	0.75	0.90	2.40	1.20
0805	2012	1.00	1.35	1.55	4.40	2.60	0.90	1.15	1.45	3.50	2.00	0.75	0.95	1.35	2.80	1.70
1206	3216	1.60	1.35	1.90	5.60	2.90	1.50	1.15	1.80	4.70	2.30	1.40	0.95	1.70	4.00	2.00
1210	3225	1.60	1.35	2.80	5.65	3.80	1.50	1.15	2.70	4.70	3.20	1.40	0.95	2.60	4.00	2.90
1210 ¹	3225	1.50	1.60	2.90	5.60	3.90	1.40	1.40	2.80	4.70	3.30	1.30	1.20	2.70	4.00	3.00
1812	4532	2.15	1.60	3.60	6.90	4.60	2.05	1.40	3.50	6.00	4.00	1.95	1.20	3.40	5.30	3.70

¹ Only for capacitance values $\geq 22 \mu\text{F}$

Density Level A: For low-density product applications. Recommended for wave solder applications and provides a wider process window for reflow solder processes. KEMET only recommends wave soldering of EIA 0603, 0805 and 1206 case sizes.

Density Level B: For products with a moderate level of component density. Provides a robust solder attachment condition for reflow solder processes.

Density Level C: For high component density product applications. Before adapting the minimum land pattern variations the user should perform qualification testing based on the conditions outlined in IPC Standard 7351 (IPC–7351).

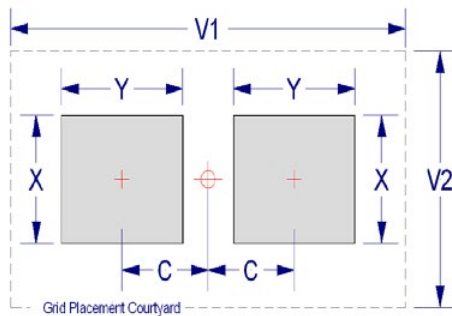

Soldering Process

Recommended Soldering Technique:

- Solder wave or solder reflow for EIA case sizes 0603, 0805 and 1206
- All other EIA case sizes are limited to solder reflow only

Recommended Soldering Profile:

- KEMET recommends following the guidelines outlined in IPC/JEDEC J–STD–020

Table 4 – Performance & Reliability: Test Methods and Conditions

Stress	Reference	Test or Inspection Method
Terminal Strength	JIS-C-6429	Appendix 1, Note: Force of 1.8 kg for 60 seconds.
Board Flex	JIS-C-6429	Appendix 2, Note: Standard termination system – 2.0 mm (minimum) for all except 3 mm for COG. Flexible termination system – 3.0 mm (minimum).
Solderability	J-STD-002	Magnification 50 X. Conditions:
		a) Method B, 4 hours @ 155°C, dry heat @ 235°C
		b) Method B @ 215°C category 3
		c) Method D, category 3 @ 260°C
Temperature Cycling	JESD22 Method JA-104	1,000 cycles (-55°C to +150°C). Measurement at 24 hours +/- 2 hours after test conclusion.
Biased Humidity	MIL-STD-202 Method 103	Load Humidity: 1,000 hours 85°C/85%RH and rated voltage. Add 100K ohm resistor. Measurement at 24 hours +/- 2 hours after test conclusion.
		Low Volt Humidity: 1,000 hours 85°C/85% RH and 1.5 V. Add 100 K ohm resistor. Measurement at 24 hours +/- 2 hours after test conclusion.
Moisture Resistance	MIL-STD-202 Method 106	t = 24 hours/cycle. Steps 7a and 7b not required. Unpowered. Measurement at 24 hours. +/- 2 hours after test conclusion.
Thermal Shock	MIL-STD-202 Method 107	-55°C/+150. Note: Number of cycles required – 300. Maximum transfer time – 20 seconds. Dwell time – 15 minutes. Air – Air.
High Temperature Life	MIL-STD-202 Method 108 /EIA-198	1,000 hours at 150°C with 2 X rated voltage applied.
Storage Life	MIL-STD-202 Method 108	150°C, 0 VDC for 1,000 hours.
Vibration	MIL-STD-202 Method 204	5 g's for 20 min., 12 cycles each of 3 orientations. Note: Use 8" X 5" PCB 0.031" thick 7 secure points on one long side and 2 secure points at corners of opposite sides. Parts mounted within 2" from any secure point. Test from 10 – 2,000 Hz
Mechanical Shock	MIL-STD-202 Method 213	Figure 1 of Method 213, Condition F.
Resistance to Solvents	MIL-STD-202 Method 215	Add aqueous wash chemical, OKEM Clean or equivalent.

Storage and Handling

Ceramic chip capacitors should be stored in normal working environments. While the chips themselves are quite robust in other environments, solderability will be degraded by exposure to high temperatures, high humidity, corrosive atmospheres, and long term storage. In addition, packaging materials will be degraded by high temperature– reels may soften or warp and tape peel force may increase. KEMET recommends that maximum storage temperature not exceed 40°C and maximum storage humidity not exceed 70% relative humidity. Temperature fluctuations should be minimized to avoid condensation on the parts and atmospheres should be free of chlorine and sulfur bearing compounds. For optimized solderability chip stock should be used promptly, preferably within 1.5 years of receipt.

Construction

Reference	Item		Material	
A	Termination System	Finish	100% Matte Sn	SnPb (5% min)
B		Barrier Layer	Ni	
C		Base Metal	Cu	
D	Inner Electrode		Ni	
E	Dielectric Material		CaZrO ₃	

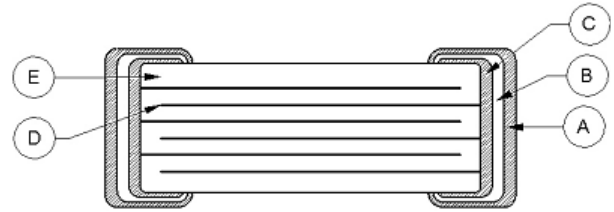

Note: Image is exaggerated in order to clearly identify all components of construction.

Capacitor Marking (Optional):

Laser marking option is not available on:

- COG, Ultra Stable X8R and Y5V dielectric devices
- EIA 0402 case size devices
- EIA 0603 case size devices with Flexible Termination option.
- KPS Commercial and Automotive grade stacked devices.

These capacitors are supplied unmarked only.

High Temperature 150°C, X8L Dielectric, 10 – 50 VDC (Commercial & Automotive Grade)

Overview

KEMET's X8L dielectric features a 150°C maximum operating temperature and is considered "general purpose high temperature." These components are fixed, ceramic dielectric capacitors suited for high temperature bypass and decoupling applications or frequency discriminating circuits where Q and stability of capacitance characteristics are not critical. X8L exhibits a predictable change in capacitance with respect to time and voltage and boasts a minimal change in capacitance with reference to ambient temperature up to 125°C. Beyond 125°C X8L displays a wider variation in capacitance. Capacitance change is limited to $\pm 15\%$ from -55°C to +125°C and +15, -40% from 125°C to 150°C.

Driven by the demand for a more robust and reliable component, X8L dielectric capacitors were developed for critical applications where reliability at higher operating temperatures are a concern. These capacitors are widely used in automotive

circuits as well as general high temperature applications. Concerned with flex cracks resulting from excessive tensile and shear stresses produced during board flexure and thermal cycling? These devices are available with KEMET's Flexible termination technology which inhibits the transfer of board stress to the rigid ceramic body, therefore mitigating flex cracks which can result in low IR or short circuit failures. Although flexible termination technology does not eliminate the potential for mechanical damage that may propagate during extreme environmental and handling conditions, it does provide superior flex performance over standard termination systems.

In addition to commercial grade, automotive grade devices are available and meet the demanding Automotive Electronics Council's AEC-Q200 qualification requirements.

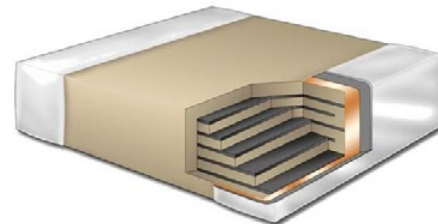

Ordering Information

C	1210	X	106	K	8	N	A	C	TU
Ceramic	Case Size (L" x W")	Specification/ Series ¹	Capacitance Code (pF)	Capacitance Tolerance	Voltage	Dielectric	Failure Rate/ Design	Termination Finish ²	Packaging/Grade (C-Spec) ³
	0402 0603 0805 1206 1210	C = Standard X = Flexible Termination	2 Significant Digits + Number of Zeros	J = $\pm 5\%$ K = $\pm 10\%$ M = $\pm 20\%$	8 = 10 V 3 = 25 V 5 = 50 V	N = X8L	A = N/A	C = 100% Matte Sn L = SnPb (5% minimum)	Blank = Bulk TU = 7" Reel Unmarked TM = 7" Reel Marked AUTO = Automotive Grade 7" Reel Unmarked

¹ The flexible termination option is not available on EIA 0402 case size product. "C" must be used in the 6th character position when ordering this case size.

² Additional termination finish options may be available. Contact KEMET for details.

³ SnPb termination finish option is not available on Automotive Grade product.

³ Additional reeling or packaging options may be available. Contact KEMET for details.

Dimensions – Standard Termination – Millimeters (Inches)

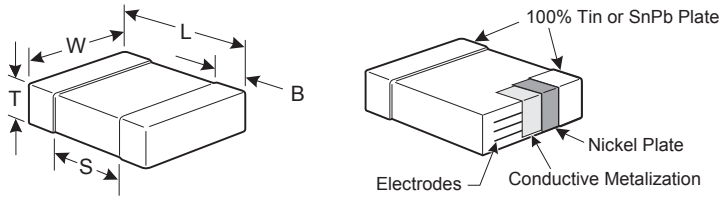

EIA Size Code	Metric Size Code	L Length	W Width	T Thickness	B Bandwidth	S Separation Minimum	Mounting Technique
0402	1005	1.00 (.040) ± 0.05 (.002)	0.50 (.020) ± 0.05 (.002)	See Table 2 for Thickness	0.30 (.012) ± 0.10 (.004)	0.30 (.012)	Solder Reflow Only
0603	1608	1.60 (.063) ± 0.15 (.006)	0.80 (.032) ± 0.15 (.006)		0.35 (.014) ± 0.15 (.006)	0.70 (.028)	Solder Wave or Solder Reflow
0805	2012	2.00 (.079) ± 0.20 (.008)	1.25 (.049) ± 0.20 (.008)		0.50 (0.02) ± 0.25 (.010)	0.75 (.030)	
1206	3216	3.20 (.126) ± 0.20 (.008)	1.60 (.063) ± 0.20 (.008)		0.50 (0.02) ± 0.25 (.010)	N/A	Solder Reflow Only
1210	3225	3.20 (.126) ± 0.20 (.008)	2.50 (.098) ± 0.20 (.008)		0.50 (0.02) ± 0.25 (.010)		

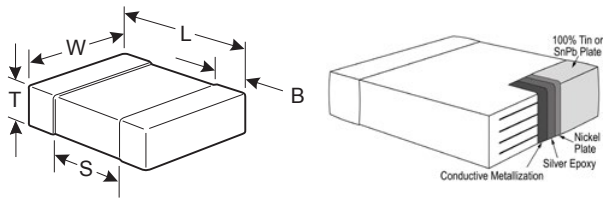

Dimensions – Flexible Termination – Millimeters (Inches)

EIA Size Code	Metric Size Code	L Length	W Width	T Thickness	B Bandwidth	S Separation Minimum	Mounting Technique
0603	1608	1.60 (.064) ± 0.17 (.007)	0.80 (.032) ± 0.15 (.006)	See Table 2 for Thickness	0.45 (.018) ± 0.15 (.006)	0.58 (.023)	Solder Wave or Solder Reflow
0805	2012	2.00 (.079) ± 0.20 (.008)	1.25 (.049) ± 0.20 (.008)		0.50 (0.02) ± 0.25 (.010)	0.75 (.030)	
1206	3216	3.30 (.130) ± 0.40 (.016)	1.60 (.063) ± 0.20 (.008)		0.60 (.024) ± 0.25 (.010)	N/A	Solder Reflow Only
1210	3225	3.30 (.130) ± 0.40 (.016)	2.50 (.098) ± 0.20 (.008)		0.60 (.024) ± 0.25 (.010)		

Benefits

- -55°C to +150°C operating temperature range
- Pb-Free and RoHS Compliant
- EIA 0402, 0603, 0805, 1206, and 1210 case sizes
- DC voltage ratings of 10 V, 25 V, and 50 V
- Capacitance offerings ranging from 0.012 µF to 10 µF
- Available capacitance tolerances of ±5%, ±10%, and ±20%
- Commercial & Automotive (AEC-Q200) grades available
- Non-polar device, minimizing installation concerns
- 100% pure matte tin-plated termination finish allowing for excellent solderability
- SnPb termination finish option available upon request (5% minimum)
- Flexible termination option available upon request

Applications

Typical applications include use in extreme environments such as down-hole oil exploration, under-hood automotive, military and aerospace.

Qualification/Certification

Commercial Grade products are subject to internal qualification. Details regarding test methods and conditions are referenced in Table 4, Performance & Reliability.

Automotive Grade products meet or exceed the requirements outlined by the Automotive Electronics Council. Details regarding test methods and conditions are referenced in document AEC-Q200, Stress Test Qualification for Passive Components. For additional information regarding the Automotive Electronics Council and AEC-Q200, please visit their website at www.aecouncil.com.

Environmental Compliance

Pb-Free and RoHS compliant (excluding SnPb termination finish option).



RoHS Compliant

Electrical Parameters/Characteristics

Item	Parameters/Characteristics
Operating Temperature Range	-55°C to +150°C
Capacitance Change with Reference to +25°C and 0 VDC Applied (TCC)	±15% (-55°C – 125°C) +15, -40% (125°C – 150°C)
Aging Rate (Maximum % Capacitance Loss/Decade Hour)	3.0%
Dielectric Withstanding Voltage (DWV)	250% of rated voltage (5 ±1 seconds and charge/discharge not exceeding 50 mA)
Dissipation Factor (DF) Maximum Limit @ 25°C	3.5% (10 V) and 2.5% (25 V and 50 V)
Insulation Resistance (IR) Limit @ 25°C	500 megohm microfarads or 10 GΩ (Rated voltage applied for 120 ±5 seconds @ 25°C)

Regarding aging rate: Capacitance measurements (including tolerance) are indexed to a referee time of 1,000 hours.

To obtain IR limit, divide $M\Omega\text{-}\mu F$ value by the capacitance and compare to $G\Omega$ limit. Select the lower of the two limits.

Capacitance and dissipation factor (DF) measured under the following conditions:

1 kHz ±50 Hz and 1.0 ±0.2 Vrms.

Note: When measuring capacitance it is important to ensure the set voltage level is held constant. The HP4284 and Agilent E4980 have a feature known as Automatic Level Control (ALC). The ALC feature should be switched to "ON."

Post Environmental Limits

High Temperature Life, Biased Humidity, Moisture Resistance					
Dielectric	Rated DC Voltage	Capacitance Value	Dissipation Factor (Maximum %)	Capacitance Shift	Insulation Resistance
X8L	> 25	All	3.0	±20%	10% of Initial Limit
	25		5.0		
	10		7.5		

Insulation Resistance Limit Table (X8L Dielectric)

EIA Case Size	1,000 Megohm Microfarads or 100 GΩ	500 Megohm Microfarads or 10 GΩ
0201	N/A	ALL
0402	< .012 μF	≥ .012 μF
0603	< .047 μF	≥ .047 μF
0805	< .047 μF	≥ .047 μF
1206	< 0.22 μF	≥ 0.22 μF
1210	< 0.39 μF	≥ 0.39 μF
1808	ALL	N/A
1812	< 2.2 μF	≥ 2.2 μF
1825	ALL	N/A
2220	< 10 μF	≥ 10 μF
2225	ALL	N/A

Table 1 – Capacitance Range/Selection Waterfall (0402 – 1210 Case Sizes)

Capacitance	Cap Code	Case Size / Series			C0402C		C0603C			C0805C			C1206C			C1210C		
		Voltage Code			8	3	8	3	5	8	3	5	8	3	5	8	3	5
		Rated Voltage (VDC)			10	25	10	25	50	10	25	50	10	25	50	10	25	50
		Capacitance Tolerance			Product Availability and Chip Thickness Codes See Table 2 for Chip Thickness Dimensions													
12,000 pF	123	J	K	M	BB	BB												
15,000 pF	153	J	K	M	BB	BB												
18,000 pF	183	J	K	M	BB	BB												
22,000 pF	223	J	K	M	BB	BB												
27,000 pF	273	J	K	M	BB	BB												
33,000 pF	333	J	K	M	BB													
39,000 pF	393	J	K	M	BB													
47,000 pF	473	J	K	M	BB		CB	CB	CB									
0.12 µF	124	J	K	M			CB	CB		DG	DG	DG						
0.15 µF	154	J	K	M			CB	CB										
0.18 µF	184	J	K	M			CB			DG	DG	DG						
0.22 µF	224	J	K	M			CB			DD	DD	DG						
0.27 µF	274	J	K	M						DD	DD							
0.33 µF	334	J	K	M						DD	DD							
0.39 µF	394	J	K	M						DE	DE					FD	FD	FD
0.47 µF	474	J	K	M						DE	DE		EG	EG	EG	FD	FD	FD
0.56 µF	564	J	K	M						DG	DH					FF	FF	FF
0.68 µF	684	J	K	M						DG	DH					FG	FG	FG
0.82 µF	824	J	K	M						DG						FL	FL	FL
1.0 µF	105	J	K	M						DG			ED	ED		FM	FM	FM
1.2 µF	125	J	K	M									EH	EH		FG	FG	
1.5 µF	155	J	K	M									EH	EH		FG	FG	
1.8 µF	185	J	K	M									EF	EH		FG	FG	
2.2 µF	225	J	K	M									EF	EH		FG	FG	
2.7 µF	275	J	K	M									EH			FG	FH	
3.3 µF	335	J	K	M									EH			FM	FM	
3.9 µF	395	J	K	M									EH			FG	FK	
4.7 µF	475	J	K	M									EH			FG	FS	
5.6 µF	565	J	K	M												FH		
6.8 µF	685	J	K	M												FM		
8.2 µF	825	J	K	M												FK		
10 µF	106	J	K	M												FS		
Capacitance	Cap Code	Rated Voltage (VDC)			10	25	10	25	50	10	25	50	10	25	50	10	25	50
		Voltage Code			8	3	8	3	5	8	3	5	8	3	5	8	3	5
		Case Size / Series			C0402C			C0603C			C0805C			C1206C			C1210C	

Table 2 – Chip Thickness/Packaging Quantities

Thickness Code	Case Size	Thickness ± Range (mm)	Paper Quantity		Plastic Quantity	
			7" Reel	13" Reel	7" Reel	13" Reel
BB	0402	0.50 ± 0.05	10,000	50,000	0	0
CB	0603	0.80 ± 0.07	4,000	10,000	0	0
DD	0805	0.90 ± 0.10	4,000	10,000	0	0
DE	0805	1.00 ± 0.10	0	0	2,500	10,000
DG	0805	1.25 ± 0.15	0	0	2,500	10,000
DH	0805	1.25 ± 0.20	0	0	2,500	10,000
ED	1206	1.00 ± 0.10	0	0	2,500	10,000
EF	1206	1.20 ± 0.15	0	0	2,500	10,000
EG	1206	1.60 ± 0.15	0	0	2,000	8,000
EH	1206	1.60 ± 0.20	0	0	2,000	8,000
FD	1210	0.95 ± 0.10	0	0	4,000	10,000
FF	1210	1.10 ± 0.10	0	0	2,500	10,000
FG	1210	1.25 ± 0.15	0	0	2,500	10,000
FL	1210	1.40 ± 0.15	0	0	2,000	8,000
FH	1210	1.55 ± 0.15	0	0	2,000	8,000
FM	1210	1.70 ± 0.20	0	0	2,000	8,000
FK	1210	2.10 ± 0.20	0	0	2,000	8,000
FS	1210	2.50 ± 0.30	0	0	1,000	4,000
Thickness Code	Case Size	Thickness ± Range (mm)	7" Reel	13" Reel	7" Reel	13" Reel
			Paper Quantity		Plastic Quantity	

Package quantity based on finished chip thickness specifications.

Table 3A – Land Pattern Design Recommendations per IPC-7351 – Standard Termination

EIA Size Code	Metric Size Code	Density Level A: Maximum (Most) Land Protrusion (mm)					Density Level B: Median (Nominal) Land Protrusion (mm)					Density Level C: Minimum (Least) Land Protrusion (mm)				
		C	Y	X	V1	V2	C	Y	X	V1	V2	C	Y	X	V1	V2
0402	1005	0.50	0.72	0.72	2.20	1.20	0.45	0.62	0.62	1.90	1.00	0.40	0.52	0.52	1.60	0.80
0603	1608	0.90	1.15	1.10	4.00	2.10	0.80	0.95	1.00	3.10	1.50	0.60	0.75	0.90	2.40	1.20
0805	2012	1.00	1.35	1.55	4.40	2.60	0.90	1.15	1.45	3.50	2.00	0.75	0.95	1.35	2.80	1.70
1206	3216	1.60	1.35	1.90	5.60	2.90	1.50	1.15	1.80	4.70	2.30	1.40	0.95	1.70	4.00	2.00
1210	3225	1.60	1.35	2.80	5.65	3.80	1.50	1.15	2.70	4.70	3.20	1.40	0.95	2.60	4.00	2.90
1210 ¹	3225	1.50	1.60	2.90	5.60	3.90	1.40	1.40	2.80	4.70	3.30	1.30	1.20	2.70	4.00	3.00

¹ Only for capacitance values ≥ 22 µF

Density Level A: For low-density product applications. Recommended for wave solder applications and provides a wider process window for reflow solder processes. KEMET only recommends wave soldering of EIA 0603, 0805 and 1206 case sizes.

Density Level B: For products with a moderate level of component density. Provides a robust solder attachment condition for reflow solder processes.

Density Level C: For high component density product applications. Before adapting the minimum land pattern variations the user should perform qualification testing based on the conditions outlined in IPC Standard 7351 (IPC-7351).

Table 3B – Land Pattern Design Recommendations per IPC–7351 – Flexible Termination

EIA Size Code	Metric Size Code	Density Level A: Maximum (Most) Land Protrusion (mm)					Density Level B: Median (Nominal) Land Protrusion (mm)					Density Level C: Minimum (Least) Land Protrusion (mm)				
		C	Y	X	V1	V2	C	Y	X	V1	V2	C	Y	X	V1	V2
0603	1608	0.85	1.25	1.10	4.00	2.10	0.75	1.05	1.00	3.10	1.50	0.65	0.85	0.90	2.40	1.20
0805	2012	1.00	1.35	1.55	4.40	2.60	0.90	1.15	1.45	3.50	2.00	0.80	0.95	1.35	2.80	1.70
1206	3216	1.60	1.65	1.90	5.90	2.90	1.50	1.45	1.80	5.00	2.30	1.40	1.25	1.70	4.30	2.00
1210	3225	1.60	1.65	2.80	5.90	3.80	1.50	1.45	2.70	5.00	3.20	1.40	1.25	2.60	4.30	2.90

Density Level A: For low-density product applications. Recommended for wave solder applications and provides a wider process window for reflow solder processes. KEMET only recommends wave soldering of EIA 0603, 0805 and 1206 case sizes.

Density Level B: For products with a moderate level of component density. Provides a robust solder attachment condition for reflow solder processes.

Density Level C: For high component density product applications. Before adapting the minimum land pattern variations the user should perform qualification testing based on the conditions outlined in IPC Standard 7351 (IPC–7351).

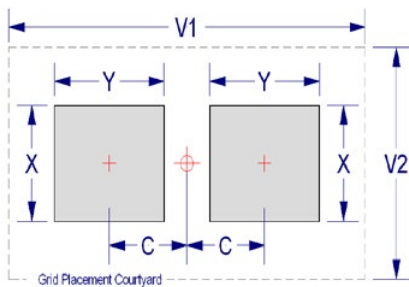

Soldering Process

Recommended Soldering Technique:

- Solder wave or solder reflow for EIA case sizes 0603, 0805 and 1206
- All other EIA case sizes are limited to solder reflow only

Recommended Soldering Profile:

- KEMET recommends following the guidelines outlined in IPC/JEDEC J–STD–020

Table 4 – Performance & Reliability: Test Methods and Conditions

Stress	Reference	Test or Inspection Method
Terminal Strength	JIS-C-6429	Appendix 1, Note: Force of 1.8 kg for 60 seconds.
Board Flex	JIS-C-6429	Appendix 2, Note: Standard termination system – 2.0 mm (minimum) for all except 3 mm for COG. Flexible termination system – 3.0 mm (minimum).
Solderability	J-STD-002	Magnification 50 X. Conditions:
		a) Method B, 4 hours @ 155°C, dry heat @ 235°C
		b) Method B @ 215°C category 3
		c) Method D, category 3 @ 260°C
Temperature Cycling	JESD22 Method JA-104	1,000 cycles (-55°C to +150°C). Measurement at 24 hours +/- 2 hours after test conclusion.
Biased Humidity	MIL-STD-202 Method 103	Load Humidity: 1,000 hours 85°C/85%RH and rated voltage. Add 100K ohm resistor. Measurement at 24 hours +/- 2 hours after test conclusion.
		Low Volt Humidity: 1,000 hours 85°C/85% RH and 1.5 V. Add 100 K ohm resistor. Measurement at 24 hours +/- 2 hours after test conclusion.
Moisture Resistance	MIL-STD-202 Method 106	t = 24 hours/cycle. Steps 7a and 7b not required. Unpowered. Measurement at 24 hours. +/- 2 hours after test conclusion.
Thermal Shock	MIL-STD-202 Method 107	-55°C/+150. Note: Number of cycles required – 300. Maximum transfer time – 20 seconds. Dwell time – 15 minutes. Air – Air.
High Temperature Life	MIL-STD-202 Method 108 /EIA-198	1,000 hours at 150°C with 2 X rated voltage applied.
Storage Life	MIL-STD-202 Method 108	150°C, 0 VDC for 1,000 hours.
Vibration	MIL-STD-202 Method 204	5 g's for 20 min., 12 cycles each of 3 orientations. Note: Use 8" X 5" PCB 0.031" thick 7 secure points on one long side and 2 secure points at corners of opposite sides. Parts mounted within 2" from any secure point. Test from 10 – 2,000 Hz
Mechanical Shock	MIL-STD-202 Method 213	Figure 1 of Method 213, Condition F.
Resistance to Solvents	MIL-STD-202 Method 215	Add aqueous wash chemical, OKEM Clean or equivalent.

Storage and Handling

Ceramic chip capacitors should be stored in normal working environments. While the chips themselves are quite robust in other environments, solderability will be degraded by exposure to high temperatures, high humidity, corrosive atmospheres, and long term storage. In addition, packaging materials will be degraded by high temperature– reels may soften or warp and tape peel force may increase. KEMET recommends that maximum storage temperature not exceed 40°C and maximum storage humidity not exceed 70% relative humidity. Temperature fluctuations should be minimized to avoid condensation on the parts and atmospheres should be free of chlorine and sulfur bearing compounds. For optimized solderability chip stock should be used promptly, preferably within 1.5 years of receipt.

Construction – Standard Termination

Reference	Item		Material	
A	Termination System	Finish	100% Matte Sn	SnPb (5% min)
B		Barrier Layer	Ni	
D		Base Metal	Cu	
E	Inner Electrode		Ni	
F	Dielectric Material		BaTiO ₃	

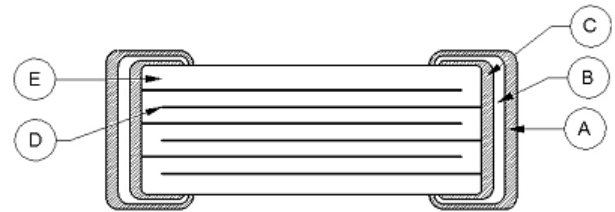

Note: Image is exaggerated in order to clearly identify all components of construction.

Construction – Flexible Termination

Reference	Item		Material	
A	Termination System	Finish	100% Matte Sn	SnPb (5% min)
B		Barrier Layer	Ni	
C		Epoxy Layer	Ag	
D	Base Metal		Cu	
E	Inner Electrode		Ni	
F	Dielectric Material		BaTiO ₃	

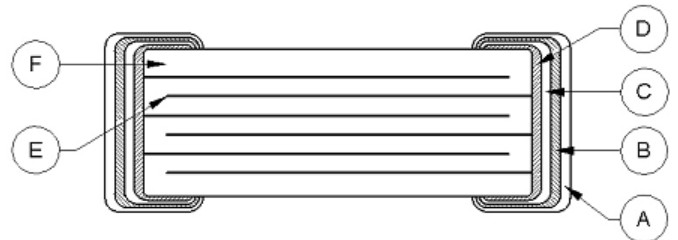

Note: Image is exaggerated in order to clearly identify all components of construction.

High Temperature 200°C, C0G Dielectric, 10 – 200 VDC (Industrial Grade)

Overview

KEMET's high temperature surface mount C0G Multilayer Ceramic Capacitors (MLCCs) feature a robust, proprietary base metal dielectric system that offers industry-leading performance relative to capacitance and case size combined with capacitance stability at extreme temperatures up to +200°C. This new platform promotes downsizing opportunities of existing high temperature C0G technology, and offers replacement opportunities of existing X7R, BX and BR dielectric technologies.

KEMET's high temperature C0G dielectric features a 200°C maximum operating temperature and is considered "stable." The Electronics Components, Assemblies & Materials Association (EIA) characterizes C0G dielectric as a Class I material. Components of this classification are temperature compensating and are suited for resonant circuit applications or those where Q and stability of capacitance characteristics are required. C0G exhibits no change in capacitance with respect to time and voltage and boasts a negligible change in capacitance with reference to ambient temperature. Capacitance change is limited to ± 30 ppm/°C from -55°C to +200°C.

Benefits

- -55°C to +200°C operating temperature range
- Pb-Free and RoHS compliant
- EIA 0402, 0603, 0805, 1206, 1210, 1812, and 2220 case sizes
- DC voltage ratings of 10 V, 16 V, 25 V, 50 V, 100 V, and 200 V
- Capacitance offerings ranging from 0.5 pF up to 0.47 μ F
- Available capacitance tolerances of ± 0.10 pF, ± 0.25 pF, ± 0.5 pF, $\pm 1\%$, $\pm 2\%$, $\pm 5\%$, $\pm 10\%$ or $\pm 20\%$
- No piezoelectric noise

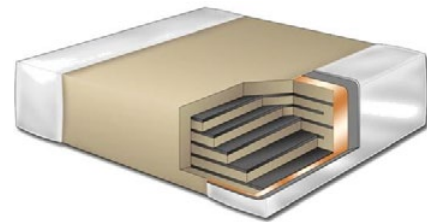

Ordering Information

C	1210	H	124	J	5	G	A	C	TU
Ceramic	Case Size (L" x W")	Specification/ Series	Capacitance Code (pF)	Capacitance Tolerance ¹	Voltage	Dielectric	Failure Rate/ Design	Termination Finish ²	Packaging/Grade (C-Spec) ³
	0402 0603 0805 1206 1210 1812 2220	H= High Temperature (200°C)	2 significant digits + number of zeros. Use 9 for 1.0 – 9.9 pF Use 8 for 0.5 – .99 pF e.g., 2.2 pF = 229 e.g., 0.5 pF = 508	B = ± 0.10 pF C = ± 0.25 pF D = ± 0.5 pF F = $\pm 1\%$ G = $\pm 2\%$ J = $\pm 5\%$ K = $\pm 10\%$ M = $\pm 20\%$	8 = 10 V 4 = 16 V 3 = 25 V 5 = 50 V 1 = 100 V 2 = 200 V	G = C0G	A = N/A	C = 100% Matte Sn L = SnPb (5% minimum)	Blank = Bulk TU = 7" Reel - Unmarked (full reel quantity) T050 = 50 pcs / 7" Reel - Unmarked T100 = 100 pcs / 7" Reel - Unmarked T250 = 250 pcs / 7" Reel - Unmarked T500 = 500 pcs / 7" Reel - Unmarked T1K0 = 1,000 pcs / Reel - Unmarked

¹ Additional capacitance tolerance offerings may be available. Contact KEMET for details.

² Additional termination finish options may be available. Contact KEMET for details.

³ Reeling quantities are dependent upon chip size and thickness dimension. When ordering using the "T1K0" packaging option, 1812 thru 2225 case size devices with chip thickness of ≥ 1.9 mm (nominal) may be shipped on multiple 7" reels or a single 13" reel. The term "Unmarked" pertains to laser marking of components. All packaging options labeled as "Unmarked" will contain capacitors that have not been laser marked. Additional reeling or packaging options may be available. Contact KEMET for details.

Dimensions – Millimeters (Inches)

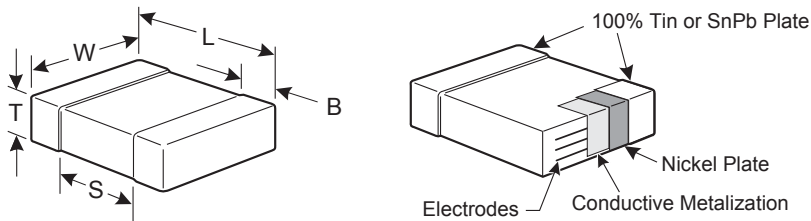

EIA Size Code	Metric Size Code	L Length	W Width	T Thickness	B Bandwidth	S Separation Minimum	Mounting Technique
0402	1005	1.00 (.040) ±0.05 (.002)	0.50 (.020) ±0.05 (.002)	See Table 2 for Thickness	0.30 (.012) ±0.10 (.004)	0.30 (.012)	Solder Reflow Only
0603	1608	1.60 (.063) ±0.15 (.006)	0.80 (.032) ±0.15 (.006)		0.35 (.014) ±0.15 (.006)	0.70 (.028)	Solder Wave or Solder Reflow
0805	2012	2.00 (.079) ±0.20 (.008)	1.25 (.049) ±0.20 (.008)		0.50 (0.02) ±0.25 (.010)	0.75 (.030)	
1206	3216	3.20 (.126) ±0.20 (.008)	1.60 (.063) ±0.20 (.008)		0.50 (0.02) ±0.25 (.010)	N/A	Solder Reflow Only
1210	3225	3.20 (.126) ±0.20 (.008)	2.50 (.098) ±0.20 (.008)		0.50 (0.02) ±0.25 (.010)		
1812	4532	4.50 (.177) ±0.30 (.012)	3.20 (.126) ±0.30 (.012)		0.60 (.024) ±0.35 (.014)		
2220	5650	5.70 (.224) ±0.40 (.016)	5.00 (.197) ±0.40 (.016)		0.60 (.024) ±0.35 (.014)		

Benefits cont'd

- Extremely low ESR and ESL
- High thermal stability
- High ripple current capability
- Preferred capacitance solution at line frequencies and into the MHz range
- No capacitance change with respect to applied rated DC voltage
- Negligible capacitance change with respect to temperature from -55°C to +200°C
- No capacitance decay with time
- Non-polar device, minimizing installation concerns
- 100% pure matte tin-plated termination finish allowing for excellent solderability

Applications

Typical applications include critical timing, tuning, circuits requiring low loss, circuits with pulse, high current, decoupling, bypass, filtering, transient voltage suppression, blocking and energy storage for use in extreme environments such as down-hole exploration, aerospace engine compartments and geophysical probes.

Qualification/Certification

High temperature (200°C) Industrial grade products meet or exceed the requirements outlined in Table 4, Performance & Reliability. Qualification packages are available for review and download on our website at www.kemet.com/hightemp

Environmental Compliance

RoHS Compliant (excluding SnPb termination finish option).



RoHS Compliant

Electrical Parameters/Characteristics

Item	Parameters/Characteristics
Operating Temperature Range	-55°C to +200°C
Capacitance Change with Reference to +25°C and 0 VDC Applied (TCC)	±30 ppm/°C (up to +200°C)
Aging Rate (Maximum % Capacitance Loss/Decade Hour)	0%
Dielectric Withstanding Voltage (DWV)	250% of rated voltage (5 ±1 second and charge/discharge not exceeding 50 mA)
Dissipation Factor (DF) Maximum Limit @ 25°C	0.1%
Insulation Resistance (IR) Limit @ 25°C	1,000 megohm microfarads or 100 GΩ
Insulation Resistance (IR) Limit @ 200°C	1,000 megohm microfarads or 100 GΩ (Rated voltage applied for 120 ±5 seconds @ 25°C)

To obtain IR limit, divide MΩ-μF value by the capacitance and compare to GΩ limit. Select the lower of the two limits.

Capacitance and Dissipation Factor (DF) measured under the following conditions:

1 MHz ±100 kHz and 1.0 Vrms ±0.2 V if capacitance ≤ 1,000 pF

1 kHz ± 50 Hz and 1.0 Vrms ±0.2 V if capacitance > 1,000 pF

Note: When measuring capacitance it is important to ensure the set voltage level is held constant. The HP4284 and Agilent E4980 have a feature known as Automatic Level Control (ALC). The ALC feature should be switched to "ON."

Post Environmental Limits

High Temperature Life, Biased Humidity, Moisture Resistance					
Dielectric	Rated DC Voltage	Capacitance Value	Dissipation Factor (Maximum %)	Capacitance Shift	Insulation Resistance
C0G	All	All	0.5	0.3% or ±0.25 pF	10% of Initial Limit

Electrical Characteristics

Delta Cap vs. Temperature (Typical)

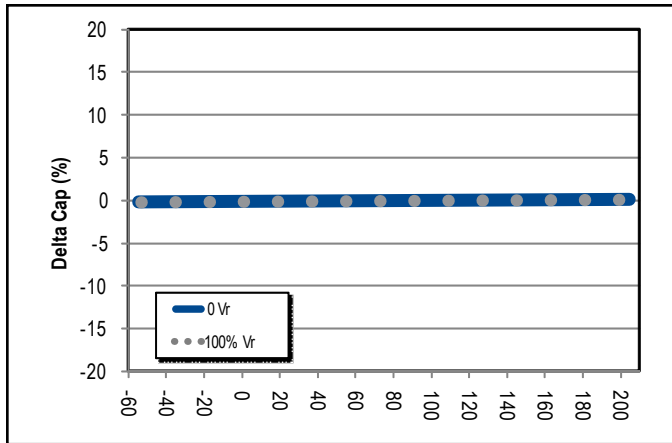

C1210H104J1GAC - Life Test IR Distribution (Lognormal)

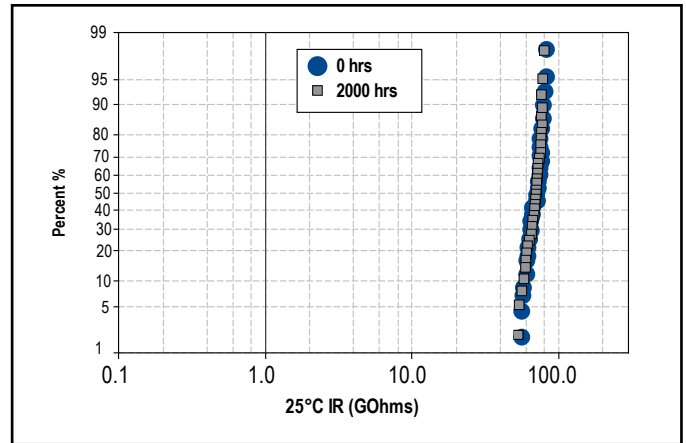

Capacitance vs. Temperature with 25 V DC Bias (Rated Voltage)

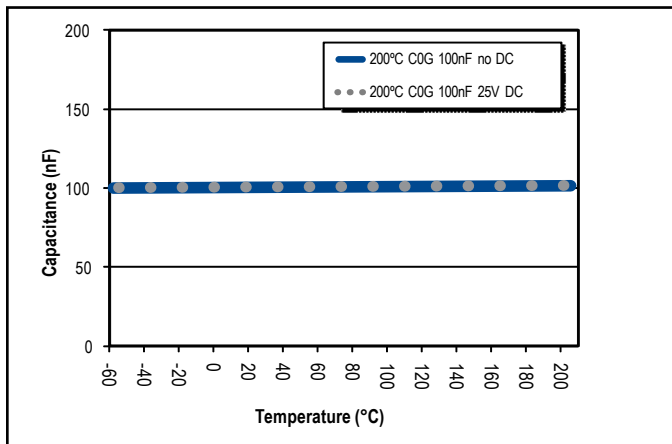

DF vs. Temperature without DC Bias.

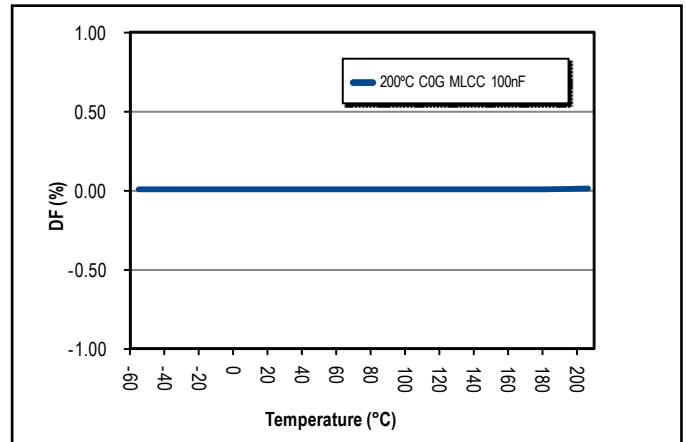

IR vs. Temperature with 25 V DC Bias (Rated Voltage)

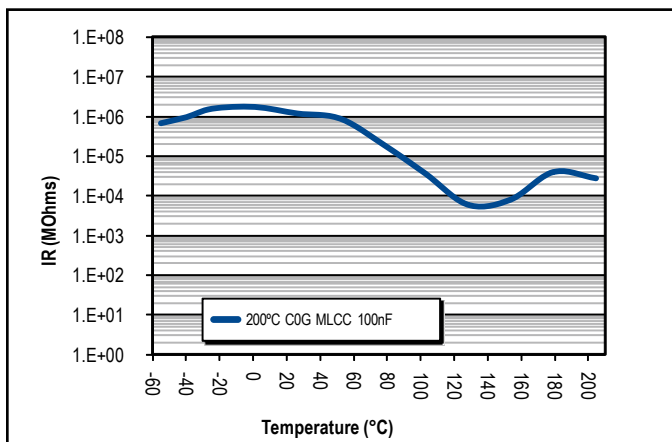

BME vs. PME/IR vs. Temperature with 25 V DC Bias (Rated Voltage)

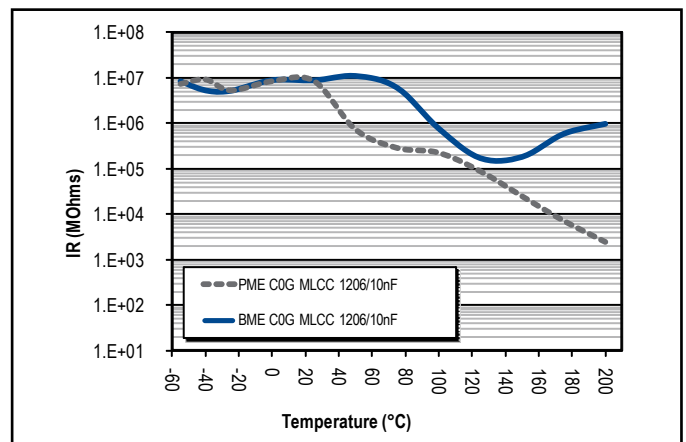

Table 1A – Capacitance Range/Selection Waterfall (0402 – 1206 Case Sizes)

Capacitance	Cap Code	Case Size / Series						C0402H					C0603H						C0805H						C1206H							
		Voltage Code						8	4	3	5	1	8	4	3	5	1	2	8	4	3	5	1	2	8	4	3	5	1	2		
		Rated Voltage (VDC)						10	16	25	50	100	10	16	25	50	100	200	10	16	25	50	100	200	10	16	25	50	100	200		
		Capacitance Tolerance						Product Availability and Chip Thickness Codes See Table 2 for Chip Thickness Dimensions																								
0.5 & 0.75 pF	508 & 758	B	C	D			BB	BB	BB	BB		CB	CB	CB	CB	CB	CB	DC	DC	DC	DC	DC	DC									
1.0 - 9.0 pF*	109 - 919*	B	C	D			BB	BB	BB	BB		CB	CB	CB	CB	CB	CB	DC	DC	DC	DC	DC	DC	EB	EB	EB	EB	EB	EB			
10 - 91 pF*	100 - 910*				F	G	J	K	M	BB	BB	BB	BB		CB	CB	CB	CB	CB	CB	DC	DC	DC	DC	DC	DC	EB	EB	EB	EB	EB	EB
100 - 180 pF*	101 - 181*				F	G	J	K	M	BB	BB	BB	BB	BB	CB	CB	CB	CB	CB	CB	DC	DC	DC	DC	DC	DC	EB	EB	EB	EB	EB	EB
200 - 430 pF*	201 - 431*				F	G	J	K	M	BB	BB	BB	BB	BB	CB	CB	CB	CB	CB	CB	DC	DC	DC	DC	DC	DC	EB	EB	EB	EB	EB	EB
470 pF	471				F	G	J	K	M	BB	BB	BB	BB	BB	CB	CB	CB	CB	CB	CB	DC	DC	DC	DC	DC	DD	EB	EB	EB	EB	EB	EB
510 pF	511				F	G	J	K	M	BB	BB	BB	BB	BB	CB	CB	CB	CB	CB	CB	DC	DC	DC	DC	DC	DC	EB	EB	EB	EB	EB	EB
560 pF	561				F	G	J	K	M	BB	BB	BB	BB	BB	CB	CB	CB	CB	CB	CB	DC	DC	DC	DC	DC	DC	EB	EB	EB	EB	EB	EB
620 pF	621				F	G	J	K	M	BB	BB	BB	BB	BB	CB	CB	CB	CB	CB	CB	DC	DC	DC	DC	DC	DC	EB	EB	EB	EB	EB	EB
680 pF	681				F	G	J	K	M	BB	BB	BB	BB	BB	CB	CB	CB	CB	CB	CB	DC	DC	DC	DC	DC	DC	EB	EB	EB	EB	EB	EB
750 pF	751				F	G	J	K	M	BB	BB	BB	BB	BB	CB	CB	CB	CB	CB	CB	DC	DC	DC	DC	DC	DC	EB	EB	EB	EB	EB	EB
820 pF	821				F	G	J	K	M	BB	BB	BB	BB	BB	CB	CB	CB	CB	CB	CB	DC	DC	DC	DC	DC	DC	EB	EB	EB	EB	EB	EB
910 pF	911				F	G	J	K	M	BB	BB	BB	BB	BB	CB	CB	CB	CB	CB	CB	DC	DC	DC	DC	DD	DD	EB	EB	EB	EB	EB	EB
1,000 pF	102				F	G	J	K	M	BB	BB	BB	BB	BB	CB	CB	CB	CB	CB	CB	DC	DC	DC	DC	DD	DD	EB	EB	EB	EB	EB	EE
1,100 pF	112				F	G	J	K	M	BB	BB	BB	BB		CB	CB	CB	CB	CB	CB	DC	DC	DC	DC	DC		EB	EB	EB	EB	EB	EB
1,200 pF	122				F	G	J	K	M	BB	BB	BB	BB		CB	CB	CB	CB	CB	CB	DC	DC	DC	DC	DC		EB	EB	EB	EB	EB	EB
1,300 pF	132				F	G	J	K	M	BB	BB	BB	BB		CB	CB	CB	CB	CB	CB	DD	DD	DD	DD	DD		EB	EB	EB	EB	EC	EC
1,500 pF	152				F	G	J	K	M	BB	BB	BB	BB		CB	CB	CB	CB	CB	CB	DD	DD	DD	DD	DD		EB	EB	EB	EB	ED	ED
1,600 pF	162				F	G	J	K	M						CB	CB	CB	CB	CB	CB	DD	DD	DD	DD	DD		EB	EB	EB	EB	ED	ED
1,800 pF	182				F	G	J	K	M						CB	CB	CB	CB	CB	CB	DD	DD	DD	DD	DD		EB	EB	EB	EB	ED	ED
2,000 pF	202				F	G	J	K	M						CB	CB	CB	CB	CB	CB	DC	DC	DC	DC	DC		EB	EB	EB	EB	ED	ED
2,200 pF	222				F	G	J	K	M						CB	CB	CB	CB	CB	CB	DC	DC	DC	DC	DC		EB	EB	EB	EB	EE	EE
2,400 pF	242				F	G	J	K	M						CB	CB	CB	CB	CB	CB	DC	DC	DC	DC	DC		EB	EB	EB	EB	EC	EC
2,700 pF	272				F	G	J	K	M						CB	CB	CB	CB	CB	CB	DC	DC	DC	DC	DC		EB	EB	EB	EB	EC	EC
3,000 pF	302				F	G	J	K	M						CB	CB	CB	CB	CB	CB	DD	DD	DD	DD	DC		EC	EC	EC	EC	EC	
3,300 pF	332				F	G	J	K	M						CB	CB	CB	CB	CB	CB	DD	DD	DD	DD	DC		EC	EC	EC	EC	EE	
3,600 pF	362				F	G	J	K	M						CB	CB	CB	CB	CB	CB	DD	DD	DD	DD	DC		EC	EC	EC	EC	EE	
3,900 pF	392				F	G	J	K	M						CB	CB	CB	CB	CB	CB	DE	DE	DE	DE	DC		EC	EC	EC	EC	EF	
4,300 pF	432				F	G	J	K	M						CB	CB	CB	CB	CB	CB	DE	DE	DE	DE	DC		EC	EC	EC	EC	EC	
4,700 pF	472				F	G	J	K	M						CB	CB	CB	CB	CB	CB	DE	DE	DE	DE	DC		EC	EC	EC	EC	EC	
5,100 pF	512				F	G	J	K	M						CB	CB	CB	CB	CB	CB	DE	DE	DE	DE	DC		ED	ED	ED	ED	ED	
5,600 pF	562				F	G	J	K	M						CB	CB	CB	CB	CB	CB	DC	DC	DC	DC	DC		ED	ED	ED	ED	ED	
6,200 pF	622				F	G	J	K	M						CB	CB	CB	CB	CB	CB	DC	DC	DC	DC	DC		EB	EB	EB	EB	EB	
6,800 pF	682				F	G	J	K	M						CB	CB	CB	CB	CB	CB	DC	DC	DC	DC	DC		EB	EB	EB	EB	EB	
7,500 pF	752				F	G	J	K	M						CB	CB	CB	CB	CB	CB	DC	DC	DC	DC	DC		EB	EB	EB	EB	EB	
8,200 pF	822				F	G	J	K	M						CB	CB	CB	CB	CB	CB	DC	DC	DC	DC	DC		EC	EC	EC	EC	EB	
9,100 pF	912				F	G	J	K	M						CB	CB	CB	CB	CB	CB	DC	DC	DC	DC	DC		EC	EC	EC	EC	EB	
10,000 pF	103				F	G	J	K	M						CB	CB	CB	CB	CB	CB	DC	DC	DC	DC	DD		ED	ED	ED	ED	EB	
12,000 pF	123				F	G	J	K	M												DC	DC	DC	DC	DE		EB	EB	EB	EB	EB	
15,000 pF	153				F	G	J	K	M												DC	DC	DC	DD	DG		EB	EB	EB	EB	EB	
18,000 pF	183				F	G	J	K	M												DC	DC	DC	DD			EB	EB	EB	EB	EB	
22,000 pF	223				F	G	J	K	M												DD	DD	DD	DF			EB	EB	EB	EB	EC	
27,000 pF	273				F	G	J	K	M												DF	DF	DF				EB	EB	EB	EB	EE	
33,000 pF	333				F	G	J	K	M												DG	DG	DG				EB	EB	EB	EB	EE	
47,000 pF	473				F	G	J	K	M																		EC	EC	EC	EE	EH	
56,000 pF	563				F	G	J	K	M																		ED	ED	ED	EF		
68,000 pF	683				F	G	J	K	M																		EF	EF	EF	EH		
82,000 pF	823				F	G	J	K	M																		EH	EH	EH	EH		
0.10 µF	104				F	G	J	K	M																		EH	EH	EH			

*Capacitance range Includes E24 decade values only. (i.e., 10, 11, 12, 13, 15, 16, 18, 20, 22, 24, 27, 30, 33, 36, 39, 43, 47, 51, 56, 62, 68, 75, 82 and 91)
 KEMET reserves the right to substitute product with an improved temperature characteristic, tighter capacitance tolerance and/or higher voltage capability within the same form factor (configuration and dimensions).
 These products are protected under US Patents 7,172,985 and 7,670,981, other patents pending, and any foreign counterparts..

Table 2 – Chip Thickness/Packaging Quantities

Thickness Code	Case Size	Thickness ± Range (mm)	Paper Quantity		Plastic Quantity	
			7" Reel	13" Reel	7" Reel	13" Reel
BB	0402	0.50 ± 0.05	10,000	50,000	0	0
CB	0603	0.80 ± 0.07	4,000	10,000	0	0
DC	0805	0.78 ± 0.10	4,000	10,000	0	0
DD	0805	0.90 ± 0.10	4,000	10,000	0	0
DE	0805	1.00 ± 0.10	0	0	2,500	10,000
DF	0805	1.10 ± 0.10	0	0	2,500	10,000
DG	0805	1.25 ± 0.15	0	0	2,500	10,000
EB	1206	0.78 ± 0.10	4,000	10,000	4,000	10,000
EC	1206	0.90 ± 0.10	0	0	4,000	10,000
ED	1206	1.00 ± 0.10	0	0	2,500	10,000
EE	1206	1.10 ± 0.10	0	0	2,500	10,000
EF	1206	1.20 ± 0.15	0	0	2,500	10,000
EH	1206	1.60 ± 0.20	0	0	2,000	8,000
FB	1210	0.78 ± 0.10	0	0	4,000	10,000
FC	1210	0.90 ± 0.10	0	0	4,000	10,000
FE	1210	1.00 ± 0.10	0	0	2,500	10,000
FF	1210	1.10 ± 0.10	0	0	2,500	10,000
FG	1210	1.25 ± 0.15	0	0	2,500	10,000
FH	1210	1.55 ± 0.15	0	0	2,000	8,000
FM	1210	1.70 ± 0.20	0	0	2,000	8,000
GB	1812	1.00 ± 0.10	0	0	1,000	4,000
GD	1812	1.25 ± 0.15	0	0	1,000	4,000
GH	1812	1.40 ± 0.15	0	0	1,000	4,000
GK	1812	1.60 ± 0.20	0	0	1,000	4,000
GN	1812	1.70 ± 0.20	0	0	1,000	4,000
JJ	2220	2.20 ± 0.15	0	0	500	2,000
Thickness Code	Case Size	Thickness ± Range (mm)	7" Reel	13" Reel	7" Reel	13" Reel
			Paper Quantity		Plastic Quantity	

Package quantity based on finished chip thickness specifications.

Table 3 – Chip Capacitor Land Pattern Design Recommendations per IPC–7351

EIA Size Code	Metric Size Code	Density Level A: Maximum (Most) Land Protrusion (mm)					Density Level B: Median (Nominal) Land Protrusion (mm)					Density Level C: Minimum (Least) Land Protrusion (mm)				
		C	Y	X	V1	V2	C	Y	X	V1	V2	C	Y	X	V1	V2
0402	1005	0.50	0.72	0.72	2.20	1.20	0.45	0.62	0.62	1.90	1.00	0.40	0.52	0.52	1.60	0.80
0603	1608	0.90	1.15	1.10	4.00	2.10	0.80	0.95	1.00	3.10	1.50	0.60	0.75	0.90	2.40	1.20
0805	2012	1.00	1.35	1.55	4.40	2.60	0.90	1.15	1.45	3.50	2.00	0.75	0.95	1.35	2.80	1.70
1206	3216	1.60	1.35	1.90	5.60	2.90	1.50	1.15	1.80	4.70	2.30	1.40	0.95	1.70	4.00	2.00
1210	3225	1.60	1.35	2.80	5.65	3.80	1.50	1.15	2.70	4.70	3.20	1.40	0.95	2.60	4.00	2.90
1210 ¹	3225	1.50	1.60	2.90	5.60	3.90	1.40	1.40	2.80	4.70	3.30	1.30	1.20	2.70	4.00	3.00
1812	4532	2.15	1.60	3.60	6.90	4.60	2.05	1.40	3.50	6.00	4.00	1.95	1.20	3.40	5.30	3.70
2220	5650	2.75	1.70	5.50	8.20	6.50	2.65	1.50	5.40	7.30	5.90	2.55	1.30	5.30	6.60	5.60

¹ Only for capacitance values $\geq 22 \mu\text{F}$

Density Level A: For low-density product applications. Recommended for wave solder applications and provides a wider process window for reflow solder processes. KEMET only recommends wave soldering of EIA 0603, 0805 and 1206 case sizes.

Density Level B: For products with a moderate level of component density. Provides a robust solder attachment condition for reflow solder processes.

Density Level C: For high component density product applications. Before adapting the minimum land pattern variations the user should perform qualification testing based on the conditions outlined in IPC Standard 7351 (IPC–7351).

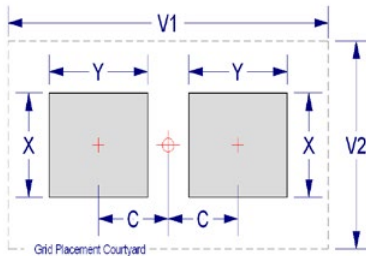

Soldering Process

Recommended Soldering Technique:

- Solder wave or solder reflow for EIA case sizes 0603, 0805 and 1206
- All other EIA case sizes are limited to solder reflow only

Recommended Reflow Soldering Profile:

KEMET's families of surface mount multilayer ceramic capacitors (SMD MLCCs) are compatible with wave (single or dual), convection, IR or vapor phase reflow techniques. Preheating of these components is recommended to avoid extreme thermal stress. KEMET's recommended profile conditions for convection and IR reflow reflect the profile conditions of the IPC/J-STD-020 standard for moisture sensitivity testing. These devices can safely withstand a maximum of three reflow passes at these conditions.

Profile Feature	Termination Finish	
	SnPb	100% Matte Sn
Preheat/Soak		
Temperature Minimum (T_{Smin})	100°C	150°C
Temperature Maximum (T_{Smax})	150°C	200°C
Time (t_s) from T_{Smin} to T_{Smax}	60 – 120 seconds	60 – 120 seconds
Ramp-Up Rate (T_L to T_p)	3°C/second maximum	3°C/second maximum
Liquidous Temperature (T_L)	183°C	217°C
Time Above Liquidous (t_L)	60 – 150 seconds	60 – 150 seconds
Peak Temperature (T_p)	235°C	260°C
Time Within 5°C of Maximum Peak Temperature (t_p)	20 seconds maximum	30 seconds maximum
Ramp-Down Rate (T_p to T_L)	6°C/second maximum	6°C/second maximum
Time 25°C to Peak Temperature	6 minutes maximum	8 minutes maximum

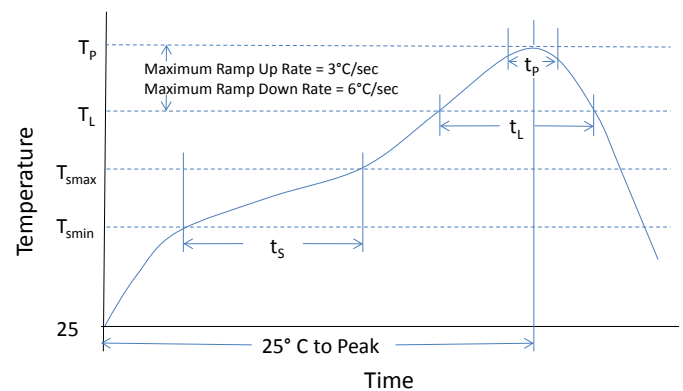

Note 1: All temperatures refer to the center of the package, measured on the capacitor body surface that is facing up during assembly reflow.

Flexible Termination System (FT-CAP), Ultra-Stable X8R Dielectric, 25 – 100 VDC (Commercial & Automotive Grade)

Overview

KEMET's Flexible Termination (FT-CAP) Multilayer Ceramic Capacitor in Ultra-Stable X8R dielectric incorporates a unique, flexible termination system that is integrated with KEMET's standard termination materials. A conductive silver epoxy is utilized between the base metal and nickel barrier layers of KEMET's standard termination system in order to establish pliability while maintaining terminal strength, solderability and electrical performance. This technology was developed in order to address the primary failure mode of MLCCs— flex cracks, which are typically the result of excessive tensile and shear stresses produced during board flexure and thermal cycling. Flexible termination technology inhibits the transfer of board stress to the rigid ceramic body, therefore mitigating flex cracks which can result in low IR or short circuit failures.

Although this technology does not eliminate the potential for mechanical damage that may propagate during extreme environmental and handling conditions, it does provide superior flex performance over standard termination systems. FT-CAP complements KEMET's Open Mode, Floating Electrode (FE-

CAP), Floating Electrode with Flexible Termination (FF-CAP), and KEMET Power Solutions (KPS) product lines by providing a complete portfolio of flex mitigation solutions.

Combined with the stability of KEMET's Ultra-Stable high temperature dielectric technology, these flex-robust devices are RoHS Compliant, offer up to 5 mm of flex-bend capability and feature a 150°C maximum operating temperature. Ultra-Stable X8R dielectric offers the same temperature capability as conventional X8R but without the capacitance loss due to applied DC voltage. These devices exhibit no change in capacitance with respect to voltage and boast a minimal change in capacitance with reference to ambient temperature. They are also suitable replacements for higher capacitance and larger footprint devices that fail to offer capacitance stability. Capacitance change with respect to temperature is limited to $\pm 15\%$ from -55°C to +150°C.

In addition to Commercial Grade, Automotive Grade devices are available which meet the demanding Automotive Electronics Council's AEC-Q200 qualification requirements.

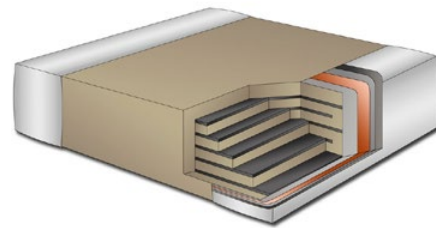

Ordering Information

C	1206	X	104	J	3	H	A	C	AUTO
Ceramic	Case Size (L" x W")	Specification/ Series	Capacitance Code (pF)	Capacitance Tolerance	Voltage	Dielectric	Failure Rate/ Design	Termination Finish ¹	Packaging/Grade (C-Spec) ²
	0603 0805 1206 1210 1812	X = Flexible Termination	2 significant digits + number of zeros.	F = $\pm 1\%$ G = $\pm 2\%$ J = $\pm 5\%$ K = $\pm 10\%$ M = $\pm 20\%$	3 = 25 V 5 = 50 V 1 = 100 V	H = Ultra-Stable X8R	A = N/A	C = 100% Matte Sn L = SnPb (5% minimum)	Blank = Bulk TU = 7" Reel Unmarked AUTO = Automotive Grade 7" Reel Unmarked

¹ Additional termination finish options may be available. Contact KEMET for details.

^{1,2} SnPb termination finish option is not available on Automotive Grade product.

² Additional reeling or packaging options may be available. Contact KEMET for details.

Dimensions – Millimeters (Inches)

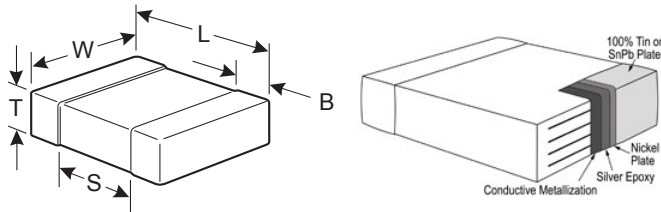

EIA Size Code	Metric Size Code	L Length	W Width	T Thickness	B Bandwidth	S Separation Minimum	Mounting Technique
0603	1608	1.60 (.064) ± 0.17 (.007)	0.80 (.032) ± 0.15 (.006)	See Table 2 for Thickness	0.45 (.018) ± 0.15 (.006)	0.58 (.023)	Solder Wave or Solder Reflow
0805	2012	2.00 (.079) ± 0.20 (.008)	1.25 (.049) ± 0.20 (.008)		0.50 (0.02) ± 0.25 (.010)	0.75 (.030)	
1206	3216	3.30 (.130) ± 0.40 (.016)	1.60 (.063) ± 0.20 (.008)		0.60 (.024) ± 0.25 (.010)	N/A	Solder Reflow Only
1210	3225	3.30 (.130) ± 0.40 (.016)	2.50 (.098) ± 0.20 (.008)		0.60 (.024) ± 0.25 (.010)		
1812	4532	4.50 (.178) ± 0.40 (.016)	3.20 (.126) ± 0.30 (.012)		0.70 (.028) ± 0.35 (.014)		

Benefits

- -55°C to +150°C operating temperature range
- Superior flex performance (up to 5 mm)
- Pb-Free and RoHS Compliant
- EIA 0603, 0805, 1206, 1210, and 1812 case sizes
- DC voltage ratings of 25 V, 50 V, and 100 V
- Capacitance offerings ranging from 430 pF to 0.22 µF
- Available capacitance tolerances of ±1%, ±2%, ±5%, ±10%, and ±20%
- Extremely low ESR and ESL
- High thermal stability
- High ripple current capability
- No capacitance change with respect to applied rated DC voltage
- Non-polar device, minimizing installation concerns
- Commercial & Automotive (AEC-Q200) Grades available
- 100% pure matte tin-plated termination finish allowing for excellent solderability
- SnPb plated termination finish option available upon request (5% minimum)

Applications

Typical applications include decoupling, bypass, filtering and transient voltage suppression in critical and safety relevant circuits without (integrated) current limitation including those subject to high levels of board flexure or temperature cycling.

Qualification/Certification

Commercial Grade products are subject to internal qualification. Details regarding test methods and conditions are referenced in Table 4, Performance & Reliability.

Automotive Grade products meet or exceed the requirements outlined by the Automotive Electronics Council. Details regarding test methods and conditions are referenced in document AEC-Q200, Stress Test Qualification for Passive Components. For additional information regarding the Automotive Electronics Council and AEC-Q200, please visit their website at www.aecouncil.com.

Environmental Compliance

Pb-Free and RoHS Compliant (excluding SnPb termination finish option)



RoHS Compliant

Electrical Parameters/Characteristics

Item	Parameters/Characteristics
Operating Temperature Range	-55°C to +150°C
Capacitance Change with Reference to +25°C and 0 VDC Applied (TCC)	±15%
Aging Rate (Maximum % Capacitance Loss/Decade Hour)	0%
Dielectric Withstanding Voltage (DWV)	250% of rated voltage (5 ±1 seconds and charge/discharge not exceeding 50 mA)
Dissipation Factor (DF) Maximum Limit @ 25°C	2.5%
Insulation Resistance (IR) Limit @ 25°C	1,000 megohm microfarads or 100 GΩ (Rated voltage applied for 120 ±5 seconds @ 25°C)

To obtain IR limit, divide MΩ-μF value by the capacitance and compare to GΩ limit. Select the lower of the two limits.

Capacitance and dissipation factor (DF) measured under the following conditions:

1 MHz ±100 kHz and 1.0 ±0.2 Vrms if capacitance ≤ 1,000 pF

1 kHz ±50 Hz and 1.0 ±0.2 Vrms if capacitance > 1,000 pF

Note: When measuring capacitance it is important to ensure the set voltage level is held constant. The HP4284 and Agilent E4980 have a feature known as Automatic Level Control (ALC). The ALC feature should be switched to "ON."

Post Environmental Limits

High Temperature Life, Biased Humidity, Moisture Resistance					
Dielectric	Rated DC Voltage	Capacitance Value	Dissipation Factor (Maximum %)	Capacitance Shift	Insulation Resistance
Ultra-Stable X8R	All	All	2.5	0.3% or ±0.25 pF	10% of Initial Limit

Table 1A – Capacitance Range/Selection Waterfall (0603 – 1812 Case Sizes)

Capacitance	Capacitance Code	Case Size / Series					C0603C			C0805C			C1206C			C1210C			C1812C	
		Voltage Code					3	5	1	3	5	1	3	5	1	3	5	1	5	1
		Rated Voltage (VDC)					25	50	100	25	50	100	25	50	100	25	50	100	50	100
		Capacitance Tolerance					Product Availability and Chip Thickness Codes See Table 2 for Chip Thickness Dimensions													
430 pF	431	F	G	J	K	M	CB	CB	CB											
470 pF	471	F	G	J	K	M	CB	CB	CB											
510 pF	511	F	G	J	K	M	CB	CB	CB											
560 pF	561	F	G	J	K	M	CB	CB	CB											
620 pF	621	F	G	J	K	M	CB	CB	CB											
680 pF	681	F	G	J	K	M	CB	CB	CB											
750 pF	751	F	G	J	K	M	CB	CB	CB											
820 pF	821	F	G	J	K	M	CB	CB	CB											
910 pF	911	F	G	J	K	M	CB	CB	CB											
1,000 pF	102	F	G	J	K	M	CB	CB	CB											
1,100 pF	112	F	G	J	K	M	CB	CB	CB											
1,200 pF	122	F	G	J	K	M	CB	CB	CB											
1,300 pF	132	F	G	J	K	M	CB	CB	CB											
1,500 pF	152	F	G	J	K	M	CB	CB	CB											
1,600 pF	162	F	G	J	K	M	CB	CB	CB											
1,800 pF	182	F	G	J	K	M	CB	CB	CB											
2,000 pF	202	F	G	J	K	M	CB	CB	CB	DC	DC	DC								
2,200 pF	222	F	G	J	K	M	CB	CB	CB	DC	DC	DC								
2,400 pF	242	F	G	J	K	M	CB	CB	CB	DC	DC	DC								
2,700 pF	272	F	G	J	K	M	CB	CB	CB	DC	DC	DC								
3,000 pF	302	F	G	J	K	M	CB	CB	CB	DC	DC	DC								
3,300 pF	332	F	G	J	K	M	CB	CB	CB	DC	DC	DC								
3,600 pF	362	F	G	J	K	M	CB	CB	CB	DC	DC	DC								
3,900 pF	392	F	G	J	K	M	CB	CB	CB	DC	DC	DC								
4,300 pF	432	F	G	J	K	M	CB	CB	CB	DC	DC	DC								
4,700 pF	472	F	G	J	K	M	CB	CB	CB	DC	DC	DC								
5,100 pF	512	F	G	J	K	M	CB	CB	CB	DC	DC	DC								
5,600 pF	562	F	G	J	K	M	CB	CB	CB	DC	DC	DC								
6,200 pF	622	F	G	J	K	M	CB	CB	CB	DC	DC	DC								
6,800 pF	682	F	G	J	K	M	CB	CB	CB	DC	DC	DC	EB	EB	EB					
7,500 pF	752	F	G	J	K	M	CB	CB	CB	DC	DC	DC	EB	EB	EB					
8,200 pF	822	F	G	J	K	M	CB	CB	CB	DC	DC	DC	EB	EB	EB					
9,100 pF	912	F	G	J	K	M	CB	CB	CB	DC	DC	DC	EB	EB	EB					
10,000 pF	103	F	G	J	K	M	CB	CB	CB	DC	DC	DD	EB	EB	EB					
12,000 pF	123	F	G	J	K	M	CB	CB	CB	DC	DC	DE	EB	EB	EB	FB	FB	FB		
15,000 pF	153	F	G	J	K	M	CB	CB	CB	DC	DD	DG	EB	EB	EB	FB	FB	FB	GB	GB
18,000 pF	183	F	G	J	K	M	CB	CB	CB	DC	DD		EB	EB	EB	FB	FB	FB	GB	GB
22,000 pF	223	F	G	J	K	M	CB	CB	CB	DD	DF		EB	EB	EC	FB	FB	FB	GB	GB
27,000 pF	273	F	G	J	K	M	CB	CB	CB	DF			EB	EB	EE	FB	FB	FB	GB	GB
33,000 pF	333	F	G	J	K	M	CB	CB	CB	DG			EB	EB	EE	FB	FB	FB	GB	GB
47,000 pF	473	F	G	J	K	M	CB	CB	CB				EC	EE	EH	FB	FB	FE	GB	GB
56,000 pF	563	F	G	J	K	M	CB	CB	CB				ED	EF	EH	FB	FB	FF	GB	GB
68,000 pF	683	F	G	J	K	M	CB	CB	CB				EF	EH		FB	FC	FG	GB	GB
82,000 pF	823	F	G	J	K	M	CB	CB	CB				EH	EH		FC	FF	FH	GB	GB
100,000 pF	104	F	G	J	K	M	CB	CB	CB				EH			FE	FG	FM	GB	GD
120,000 pF	124	F	G	J	K	M	CB	CB	CB							FG	FH		GB	GH
150,000 pF	154	F	G	J	K	M	CB	CB	CB							FH	FM		GD	GN
180,000 pF	184	F	G	J	K	M	CB	CB	CB							FJ			GH	
220,000 pF	224	F	G	J	K	M	CB	CB	CB										GK	
Capacitance	Capacitance Code	Rated Voltage (VDC)					25	50	100	25	50	100	25	50	100	25	50	100	50	100
		Voltage Code					3	5	1	3	5	1	3	5	1	3	5	1	5	1
		Case Size / Series					C0603C			C0805C			C1206C			C1210C			C1812C	

Table 2 – Chip Thickness/Packaging Quantities

Thickness Code	Case Size	Thickness ± Range (mm)	Paper Quantity		Plastic Quantity	
			7" Reel	13" Reel	7" Reel	13" Reel
CB	0603	0.80 ± 0.07	4,000	10,000	0	0
DC	0805	0.78 ± 0.10	0	0	4,000	10,000
DD	0805	0.90 ± 0.10	0	0	4,000	10,000
DE	0805	1.00 ± 0.10	0	0	2,500	10,000
DF	0805	1.10 ± 0.10	0	0	2,500	10,000
DG	0805	1.25 ± 0.15	0	0	2,500	10,000
EB	1206	0.78 ± 0.10	4,000	10,000	4,000	10,000
EC	1206	0.90 ± 0.10	0	0	4,000	10,000
ED	1206	1.00 ± 0.10	0	0	2,500	10,000
EE	1206	1.10 ± 0.10	0	0	2,500	10,000
EF	1206	1.20 ± 0.15	0	0	2,500	10,000
EH	1206	1.60 ± 0.20	0	0	2,000	8,000
FB	1210	0.78 ± 0.10	0	0	4,000	10,000
FC	1210	0.90 ± 0.10	0	0	4,000	10,000
FE	1210	1.00 ± 0.10	0	0	2,500	10,000
FF	1210	1.10 ± 0.10	0	0	2,500	10,000
FG	1210	1.25 ± 0.15	0	0	2,500	10,000
FH	1210	1.55 ± 0.15	0	0	2,000	8,000
FM	1210	1.70 ± 0.20	0	0	2,000	8,000
FJ	1210	1.85 ± 0.20	0	0	2,000	8,000
GB	1812	1.00 ± 0.10	0	0	1,000	4,000
GD	1812	1.25 ± 0.15	0	0	1,000	4,000
GH	1812	1.40 ± 0.15	0	0	1,000	4,000
GK	1812	1.60 ± 0.20	0	0	1,000	4,000
GN	1812	1.70 ± 0.20	0	0	1,000	4,000
Thickness Code	Case Size	Thickness ± Range (mm)	7" Reel	13" Reel	7" Reel	13" Reel
			Paper Quantity		Plastic Quantity	

Package quantity based on finished chip thickness specifications.

Table 3 – Chip Capacitor Land Pattern Design Recommendations per IPC–7351 (mm)

EIA Size Code	Metric Size Code	Density Level A: Maximum (Most) Land Protrusion (mm)					Density Level B: Median (Nominal) Land Protrusion (mm)					Density Level C: Minimum (Least) Land Protrusion (mm)				
		C	Y	X	V1	V2	C	Y	X	V1	V2	C	Y	X	V1	V2
0603	1608	0.85	1.25	1.10	4.00	2.10	0.75	1.05	1.00	3.10	1.50	0.65	0.85	0.90	2.40	1.20
0805	2012	1.00	1.35	1.55	4.40	2.60	0.90	1.15	1.45	3.50	2.00	0.80	0.95	1.35	2.80	1.70
1206	3216	1.60	1.65	1.90	5.90	2.90	1.50	1.45	1.80	5.00	2.30	1.40	1.25	1.70	4.30	2.00
1210	3225	1.60	1.65	2.80	5.90	3.80	1.50	1.45	2.70	5.00	3.20	1.40	1.25	2.60	4.30	2.90
1812	4532	2.10	1.80	3.60	7.00	4.60	2.00	1.60	3.50	6.10	4.00	1.90	1.40	3.40	5.40	3.70

Density Level A: For low-density product applications. Recommended for wave solder applications and provides a wider process window for reflow solder processes. KEMET only recommends wave soldering of EIA 0603, 0805, and 1206 case sizes.

Density Level B: For products with a moderate level of component density. Provides a robust solder attachment condition for reflow solder processes.

Density Level C: For high component density product applications. Before adapting the minimum land pattern variations the user should perform qualification testing based on the conditions outlined in IPC Standard 7351 (IPC–7351).

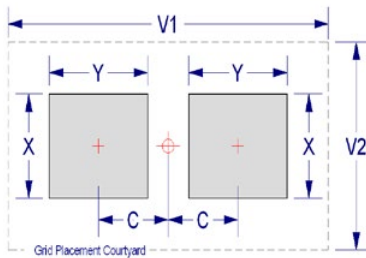

Soldering Process

Recommended Soldering Technique:

- Solder wave or solder reflow for EIA case sizes 0603, 0805, and 1206
- All other EIA case sizes are limited to solder reflow only

Recommended Soldering Profile:

- KEMET recommends following the guidelines outlined in IPC/JEDEC J–STD–020

Table 4 – Performance & Reliability: Test Methods and Conditions

Stress	Reference	Test or Inspection Method
Terminal Strength	JIS-C-6429	Appendix 1, Note: Force of 1.8 kg for 60 seconds.
Board Flex	JIS-C-6429	Appendix 2, Note: Standard termination system – 2.0 mm (minimum) for all except 3 mm for COG. Flexible termination system – 3.0 mm (minimum).
Solderability	J-STD-002	Magnification 50 X. Conditions:
		a) Method B, 4 hours @ 155°C, dry heat @ 235°C
		b) Method B @ 215°C category 3
		c) Method D, category 3 @ 260°C
Temperature Cycling	JESD22 Method JA-104	1,000 cycles (-55°C to +150°C). Measurement at 24 hours +/- 2 hours after test conclusion.
Biased Humidity	MIL-STD-202 Method 103	Load Humidity: 1,000 hours 85°C/85%RH and rated voltage. Add 100K ohm resistor. Measurement at 24 hours +/- 2 hours after test conclusion.
		Low Volt Humidity: 1,000 hours 85°C/85% RH and 1.5 V. Add 100 K ohm resistor. Measurement at 24 hours +/- 2 hours after test conclusion.
Moisture Resistance	MIL-STD-202 Method 106	t = 24 hours/cycle. Steps 7a and 7b not required. Unpowered. Measurement at 24 hours. +/- 2 hours after test conclusion.
Thermal Shock	MIL-STD-202 Method 107	-55°C/+150. Note: Number of cycles required – 300. Maximum transfer time – 20 seconds. Dwell time – 15 minutes. Air – Air.
High Temperature Life	MIL-STD-202 Method 108 /EIA-198	1,000 hours at 150°C with 2 X rated voltage applied.
Storage Life	MIL-STD-202 Method 108	150°C, 0 VDC for 1,000 hours.
Vibration	MIL-STD-202 Method 204	5 g's for 20 min., 12 cycles each of 3 orientations. Note: Use 8" X 5" PCB 0.031" thick 7 secure points on one long side and 2 secure points at corners of opposite sides. Parts mounted within 2" from any secure point. Test from 10 – 2,000 Hz
Mechanical Shock	MIL-STD-202 Method 213	Figure 1 of Method 213, Condition F.
Resistance to Solvents	MIL-STD-202 Method 215	Add aqueous wash chemical, OKEM Clean or equivalent.

Storage and Handling

Ceramic chip capacitors should be stored in normal working environments. While the chips themselves are quite robust in other environments, solderability will be degraded by exposure to high temperatures, high humidity, corrosive atmospheres, and long term storage. In addition, packaging materials will be degraded by high temperature– reels may soften or warp and tape peel force may increase. KEMET recommends that maximum storage temperature not exceed 40°C and maximum storage humidity not exceed 70% relative humidity. Temperature fluctuations should be minimized to avoid condensation on the parts and atmospheres should be free of chlorine and sulfur bearing compounds. For optimized solderability chip stock should be used promptly, preferably within 1.5 years of receipt.

Construction

Reference	Item	Material	
A	Termination System	Finish	100% Matte Sn
B		Barrier Layer	Ni
C		Epoxy Layer	Ag
D		Base Metal	Cu
E	Inner Electrode	Ni	
F	Dielectric Material	CaZrO ₃	

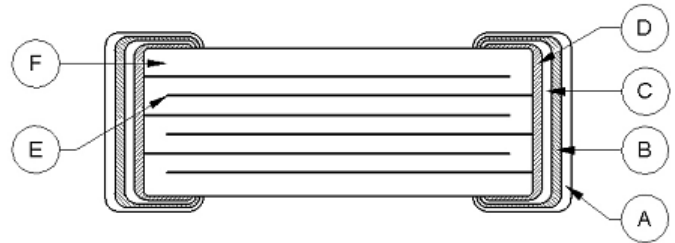

Note: Image is exaggerated in order to clearly identify all components of construction.

Capacitor Marking (Optional):

Laser marking option is not available on:

- COG, Ultra Stable X8R and Y5V dielectric devices
- EIA 0402 case size devices
- EIA 0603 case size devices with Flexible Termination option.
- KPS Commercial and Automotive grade stacked devices.

These capacitors are supplied unmarked only.

KPS HT Series, High Temperature 150°C, X8L Dielectric, 10 VDC – 50 VDC (Commercial & Automotive Grade)

Overview

KEMET Power Solutions High Temperature (KPS HT) stacked capacitors utilize a proprietary lead-frame technology to vertically stack one or two multilayer ceramic chip capacitors into a single compact surface mount package. The attached lead-frame mechanically isolates the capacitor(s) from the printed circuit board, thereby offering advanced mechanical and thermal stress performance. Isolation also addresses concerns for audible, microphonic noise that may occur when a bias voltage is applied. A two-chip stack offers up to double the capacitance in the same or smaller design footprint when compared to traditional surface mount MLCC devices. Providing up to 10 mm of board flex capability, KPS Series capacitors are environmentally friendly and in compliance with RoHS legislation. Combined with X8L dielectric, these devices are

capable of reliable operation up to 150°C and are well suited for high temperature filtering, bypass and decoupling applications.

X8L exhibits a predictable change in capacitance with respect to time and voltage, and boasts a minimal change in capacitance with reference to ambient temperature up to 125°C. Beyond 125°C, X8L displays a wider variation in capacitance. Capacitance change is limited to $\pm 15\%$ from -55°C to +125°C and +15, -40% from 125°C to 150°C.

In addition to Commercial grade, Automotive grade devices are available and meet the demanding Automotive Electronics Council's AEC-Q200 qualification requirements.

Benefits

- -55°C to +150°C operating temperature range
- Reliable and robust termination system
- EIA 1210 and 2220 case sizes
- DC voltage ratings of 10 V, 16 V, 25 V, and 50 V
- Capacitance offerings ranging from 0.47 μF up to 47 μF
- Available capacitance tolerances of $\pm 10\%$ and $\pm 20\%$
- Higher capacitance in the same footprint
- Potential board space savings
- Advanced protection against thermal and mechanical stress
- Provides up to 10 mm of board flex capability
- Reduces audible, microphonic noise
- Extremely low ESR and ESL
- Pb-Free and RoHS Compliant
- Capable of Pb-Free reflow profiles
- Non-polar device, minimizing installation concerns
- Tantalum and electrolytic alternative
- Commercial & Automotive (AEC-Q200) grades available



Ordering Information

C	2220	C	476	M	4	N	2	C	7186
Ceramic	Case Size (L"x W")	Specification/ Series	Capacitance Code (pF)	Capacitance Tolerance ¹	Rated Voltage (VDC)	Dielectric	Failure Rate/ Design	Leadframe Finish	Packaging/Grade (C-Spec)
	1210 2220	C = Standard	2 significant digits + number of zeros.	K = $\pm 10\%$ M = $\pm 20\%$	8 = 10 V 4 = 16 V 3 = 25 V 5 = 50 V	N = X8L	1 = KPS Single Chip Stack 2 = KPS Double Chip Stack	C = 100% Matte Sn	7186 = 7" Reel Unmarked 7289 = 13" Reel Unmarked AUTO = Automotive Grade 7" Reel Unmarked AUTO7289 = Automotive Grade 13" Reel Unmarked

¹ Double chip stacks ("2" in the 13th character position of the ordering code) are only available in M ($\pm 20\%$) capacitance tolerance.

Dimensions – Millimeters (Inches)

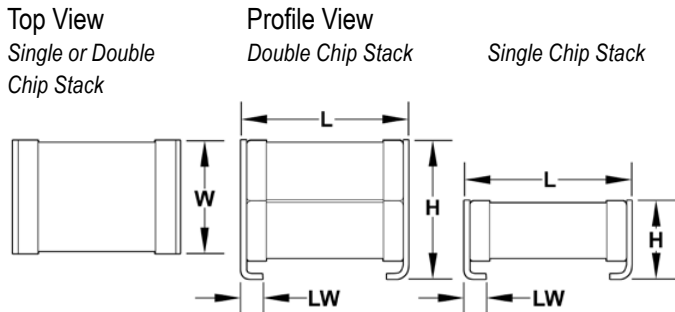

Chip Stack	EIA Size Code	Metric Size Code	L Length	W Width	H Height	LW Lead Width	Mounting Technique
Single	1210	3225	3.50 (.138) ±0.30 (.012)	2.60 (.102) ±0.30 (.012)	3.35 (.132) ±0.10 (.004)	0.80 (.032) ±0.15 (.006)	Solder Reflow Only
	2220	5650	6.00 (.236) ±0.50 (.020)	5.00 (.197) ±0.50 (.020)	3.50 (.138) ±0.30 (.012)	1.60 (.063) ±0.30 (.012)	
Double	1210	3225	3.50 (.138) ±0.30 (.012)	2.60 (.102) ±0.30 (.012)	6.15 (.242) ±0.15 (.006)	0.80 (.031) ±0.15 (.006)	
	2220	5650	6.00 (.236) ±0.50 (.020)	5.00 (.197) ±0.50 (.020)	5.00 (.197) ±0.50 (.020)	1.60 (.063) ±0.30 (.012)	

Applications

Typical applications include smoothing circuits, DC/DC converters, power supplies (input/output filters), noise reduction (piezoelectric/mechanical), circuits with a direct battery or power source connection, critical and safety relevant circuits without (integrated) current limitation and any application that is subject to extreme environments such as high temperature, high levels of board flexure and/or temperature cycling. Markets include industrial, aerospace, automotive, and telecom.

Qualification/Certification

Commercial Grade products are subject to internal qualification. Details regarding test methods and conditions are referenced in Table 4, Performance & Reliability.

Automotive Grade products meet or exceed the requirements outlined by the Automotive Electronics Council. Details regarding test methods and conditions are referenced in document AEC-Q200, Stress Test Qualification for Passive Components. For additional information regarding the Automotive Electronics Council and AEC-Q200, please visit their website at www.aecouncil.com.

Environmental Compliance

Pb-Free and RoHS Compliant.



RoHS Compliant

Electrical Parameters/Characteristics

Item	Parameters/Characteristics
Operating Temperature Range	-55°C to +150°C
Capacitance Change with Reference to +25°C and 0 VDC Applied (TCC)	±15% (-55°C to 125°C), +15, -40% (125°C to 150°C)
Aging Rate (Maximum % Capacitance Loss/Decade Hour)	3.0%
Dielectric Withstanding Voltage (DWV)	250% of rated voltage (5 ±1 seconds and charge/discharge not exceeding 50 mA)
Dissipation Factor (DF) Maximum Limit @ 25°C	3.5% (10 V and 16 V) and 2.5% (25 V and 50 V)
Insulation Resistance (IR) Limit @ 25°C	500 megohm microfarads or 10 GΩ (Rated voltage applied for 120 ±5 seconds @ 25°C)

Regarding Aging Rate: Capacitance measurements (including tolerance) are indexed to a referee time of 1,000 hours.

To obtain IR limit, divide MΩ - μF value by the capacitance and compare to GΩ limit. Select the lower of the two limits.

Capacitance and Dissipation Factor (DF) measured under the following conditions:

1 kHz ±50 Hz and 1.0 ±0.2 Vrms.

Note: When measuring capacitance it is important to ensure the set voltage level is held constant. The HP4284 and Agilent E4980 have a feature known as Automatic Level Control (ALC). The ALC feature should be switched to "ON."

Post Environmental Limits

High Temperature Life, Biased Humidity, Moisture Resistance					
Dielectric	Rated DC Voltage	Capacitance Value	Dissipation Factor (Maximum %)	Capacitance Shift	Insulation Resistance
X8L	> 25	All	3.0	±20%	10% of Initial Limit
	16 / 25		5.0		
	10		7.5		

Table 1 – Capacitance Range/Selection Waterfall (1210 – 2220 Case Sizes)

Capacitance	Cap Code	Case Size / Series			C1210C						C2220C					
		Voltage Code			8	4	3	5	1	A	8	4	3	5	1	A
		Rated Voltage (VDC)			10	16	25	50	100	250	10	16	25	50	100	250
		Capacitance Tolerance			Product Availability and Chip Thickness Codes – See Table 2 for Chip Thickness Dimensions											
Single Chip Stack																
0.47 µF	474		K	M	FV	FV	FV	FV								
1.0 µF	105		K	M	FV	FV	FV	FV								
2.2 µF	225		K	M	FV	FV	FV	FV					JP	JP	JP	
3.3 µF	335		K	M	FV	FV	FV	FV					JP	JP	JP	
4.7 µF	475		K	M	FV	FV	FV	FV					JP	JP	JP	
10 µF	106		K	M									JP	JP	JP	
15 µF	156		K	M									JP	JP	JP	
22 µF	226		K	M									JP	JP	JP	
Double Chip Stack																
1.0 µF	105			M	FW	FW	FW	FW								
2.2 µF	225			M	FW	FW	FW	FW								
3.3 µF	335			M	FW	FW	FW	FW								
4.7 µF	475			M	FW	FW	FW	FW					JR	JR	JR	
10 µF	106			M	FW	FW	FW	FW					JR	JR	JR	
22 µF	226			M									JR	JR	JR	
33 µF	336			M									JR	JR	JR	
47 µF	476			M									JR	JR	JR	
Capacitance	Cap Code	Rated Voltage (VDC)			10	16	25	50	100	250	10	16	25	50	100	250
		Voltage Code			8	4	3	5	1	A	8	4	3	5	1	A
		Case Size / Series			C1210C						C2220C					

These products are protected under US Patent 8,331,078 other patents pending, and any foreign counterparts.

Table 2 – Chip Thickness/Packaging Quantities

Thickness Code	Case Size	Thickness ± Range (mm)	Paper Quantity		Plastic Quantity	
			7" Reel	13" Reel	7" Reel	13" Reel
FV	1210	3.35 ± 0.10	0	0	600	2,000
FW	1210	6.15 ± 0.15	0	0	300	1,000
JP	2220	3.50 ± 0.30	0	0	300	1,300
JR	2220	5.00 ± 0.50	0	0	200	800

Package quantity based on finished chip thickness specifications.

Table 3 – KPS Land Pattern Design Recommendations (mm)

EIA SIZE CODE	METRIC SIZE CODE	Median (Nominal) Land Protrusion				
		C	Y	X	V1	V2
1210	3225	1.50	1.14	1.75	5.05	3.40
2220	5650	2.69	2.08	4.78	7.70	6.00

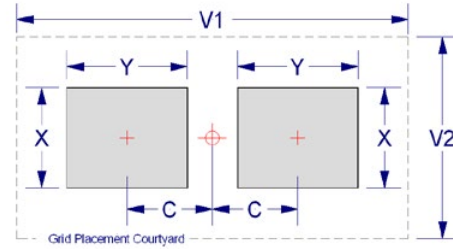

Soldering Process

KEMET's KPS Series devices are compatible with IR reflow techniques. Preheating of these components is recommended to avoid extreme thermal stress. KEMET's recommended profile conditions for IR reflow reflect the profile conditions of the IPC/J–STD–020D standard for moisture sensitivity testing.

To prevent degradation of temperature cycling capability, care must be taken to prevent solder from flowing into the inner side of the lead frames (inner side of "J" lead in contact with the circuit board).

After soldering, the capacitors should be air cooled to room temperature before further processing. Forced air cooling is not recommended.

Hand soldering should be performed with care due to the difficulty in process control. If performed, care should be taken to avoid contact of the soldering iron to the capacitor body. The iron should be used to heat the solder pad, applying solder between the pad and the lead, until reflow occurs. Once reflow occurs, the iron should be removed immediately. (Preheating is required when hand soldering to avoid thermal shock.)

Profile Feature	SnPb Assembly	Pb-Free Assembly
Preheat/Soak		
Temperature Minimum (T_{Smin})	100°C	150°C
Temperature Maximum (T_{Smax})	150°C	200°C
Time (t_s) from T_{Smin} to T_{Smax}	60 – 120 seconds	60 – 120 seconds
Ramp-up Rate (T_L to T_p)	3°C/seconds maximum	3°C/seconds maximum
Liquidous Temperature (T_L)	183°C	217°C
Time Above Liquidous (t_L)	60 – 150 seconds	60 – 150 seconds
Peak Temperature (T_p)	235°C	250°C
Time within 5°C of Maximum Peak Temperature (t_p)	20 seconds maximum	10 seconds maximum
Ramp-down Rate (T_p to T_L)	6°C/seconds maximum	6°C/seconds maximum
Time 25°C to Peak Temperature	6 minutes maximum	8 minutes maximum

Note: All temperatures refer to the center of the package, measured on the package body surface that is facing up during assembly reflow.

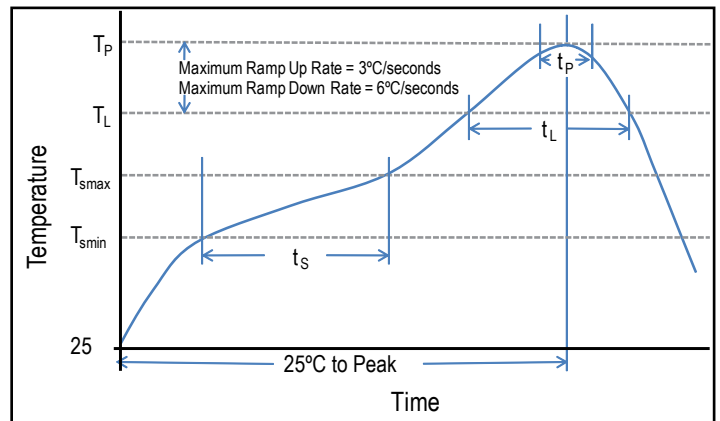

Table 4 – Performance & Reliability: Test Methods and Conditions

Stress	Reference	Test or Inspection Method
Terminal Strength	JIS-C-6429	Appendix 1, Note: Force of 1.8 kg for 60 seconds.
Board Flex	JIS-C-6429	Appendix 2, Note: 5.0 mm minimum
Solderability	J-STD-002	Magnification 50 X. Conditions:
		a) Method B, 4 hours @ 155°C, dry heat @ 235°C
		b) Method B @ 215°C category 3
		c) Method D, category 3 @ 250°C
Temperature Cycling	JESD22 Method JA-104	1,000 cycles (-55°C to +150°C). Measurement at 24 hours +/- 2 hours after test conclusion.
Biased Humidity	MIL-STD-202 Method 103	Load Humidity: 1,000 hours 85°C/85% RH and rated voltage. Add 100 K ohm resistor. Measurement at 24 hours +/- 2 hours after test conclusion.
		Low Volt Humidity: 1,000 hours 85°C/85% RH and 1.5 V. Add 100 K ohm resistor. Measurement at 24 hours +/- 2 hours after test conclusion.
Moisture Resistance	MIL-STD-202 Method 106	t = 24 hours/cycle. Steps 7a and 7b not required. Unpowered. Measurement at 24 hours +/- 2 hours after test conclusion.
Thermal Shock	MIL-STD-202 Method 107	-55°C/+150°C. Note: Number of cycles required- 300, maximum transfer time- 20 seconds, Dwell time- 15 minutes. Air-Air.
High Temperature Life	MIL-STD-202 Method 108	1,000 hours at 150°C with rated voltage applied.
Storage Life	MIL-STD-202 Method 108	150°C, 0 VDC for 1,000 hours.
Vibration	MIL-STD-202 Method 204	5 g's for 20 minutes, 12 cycles each of 3 orientations. Note: Use 8" X 5" PCB .031" thick, 7 secure points on one long side and 2 secure points at corners of opposite sides. Parts mounted within 2" from any secure point. Test from 10 – 2,000 Hz.
Mechanical Shock	MIL-STD-202 Method 213	Figure 1 of Method 213, Condition F.
Resistance to Solvents	MIL-STD-202 Method 215	Add aqueous wash chemical, OKEM Clean or equivalent.

Storage & Handling

Ceramic chip capacitors should be stored in normal working environments. While the chips themselves are quite robust in other environments, solderability will be degraded by exposure to high temperatures, high humidity, corrosive atmospheres, and long term storage. In addition, packaging materials will be degraded by high temperature– reels may soften or warp and tape peel force may increase. KEMET recommends that maximum storage temperature not exceed 40°C and maximum storage humidity not exceed 70% relative humidity. Temperature fluctuations should be minimized to avoid condensation on the parts and atmospheres should be free of chlorine and sulfur bearing compounds. For optimized solderability chip stock should be used promptly, preferably within 1.5 years of receipt.

Construction

Reference	Item	Material
A	Leadframe	Phosphor Bronze – Alloy 510
B	Leadframe Attach	HMP Solder
C	Termination	Cu
D		Ni
E		Sn
F	Inner Electrode	Ni
G	Dielectric Material	BaTiO ₃

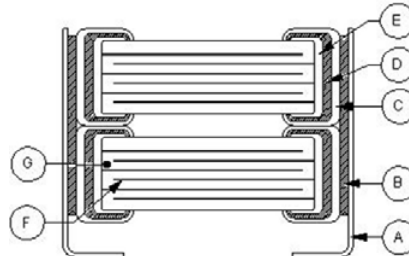

*Note: Image is exaggerated in order to clearly identify all components of construction.
 HMP = High Melting Point*

Product Marking

Laser marking option is not available on:

- COG, Ultra Stable X8R and Y5V dielectric devices
- EIA 0402 case size devices
- EIA 0603 case size devices with Flexible Termination option.
- KPS Commercial and Automotive grade stacked devices.

These capacitors are supplied unmarked only.

Pulse Detonation, High Voltage, High Temperature 200°C, C0G Dielectric, 500 – 2,000 VDC (Industrial Grade)

Overview

KEMET's Industrial Grade Pulse Detonation Series surface mount capacitors in C0G dielectric deliver reliable, high voltage and high temperature performance required for operation in harsh environments, specifically detonation circuitry. Constructed of a robust and proprietary base metal electrode (BME) dielectric system, these devices offer industry-leading performance relative to capacitance and case size. KEMET Pulse Detonation capacitors average greater than 30% higher breakdown voltage than competitive precious metal electrode (PME) devices with similar capacitance and voltage ratings.

Designed for down-hole oil exploration and perforation, these devices feature a 200°C maximum operating temperature. The Electronics Industries Alliance (EIA) characterizes C0G

dielectric as a Class I material. Components of this classification are temperature compensating and are suited for resonant circuit applications or those where Q and stability of capacitance characteristics are required. Pulse Detonation Series capacitors in C0G dielectric exhibit no change in capacitance with respect to time and voltage and boast a negligible change in capacitance with reference to ambient temperature. These devices retain high insulation resistance with low dissipation factor at elevated temperatures up to 200°C.

KEMET's Pulse Detonation surface mount MLCCs are manufactured in state-of-the-art ISO/TS 16949:2002 certified facilities and are proven to function reliably in harsh, high temperature and high humidity down-hole environments.

Benefits

- -55°C to +200°C operating temperature range
- Pb-Free and RoHS Compliant
- Base metal technology
- High breakdown voltage capability up to +200°C
- Higher UVBD capability than competitive dielectric technologies
- Capacitance offerings ranging from 0.5 pF up to 0.15 µF
- Available capacitance tolerances of ±5%, ±10% or ±20%
- Extremely low ESR and ESL
- High thermal stability

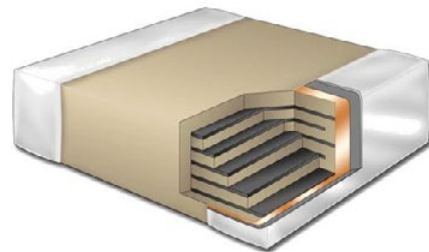

Ordering Information

Contact KEMET for ordering information									
Ceramic	Case Size (L" x W")	Specification/ Series	Capacitance Code (pF)	Capacitance Tolerance	Rated Voltage (VDC) ¹	Dielectric	Failure Rate/ Design	Termination Finish ²	Packaging/Grade (C-Spec) ³
	2824 3040 3640 4040 4540	H= High Temp (200°C)	2 Significant Digits + Number of Zeros	J = ±5% K = ±10% M = ±20%	C = 500 V B = 630 V D = 1,000 V F = 1,500 V G = 2,000 V	G = C0G	W = Pulse Detonation	C = 100% Matte Sn	Contact KEMET for packaging availability and details

¹ For breakdown voltage (UVBD) values see Table 1, Pulse Detonation Series, Capacitance Range Waterfall.

² Additional termination finish options may be available. Contact KEMET for details.

³ Additional reeling or packaging options may be available. Contact KEMET for details.

Dimensions – Millimeters (Inches)

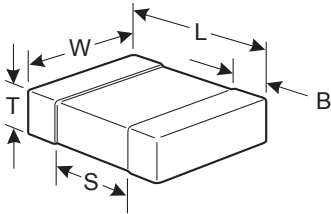

Size Code	L Length	W Width	T Thickness Maximum	B Bandwidth	S Separation Minimum	Mounting Technique
2824	7.10 ± 0.40 (0.280 ± 0.016)	6.10 ± 0.40 (0.240 ± 0.016)	2.5 (0.098)	0.76 ± 0.40 (0.030 ± 0.016)	N/A	Solder Reflow Only
3040	7.60 ± 0.40 (0.300 ± 0.016)	10.20 ± 0.40 (0.402 ± 0.016)				
3640	9.10 ± 0.40 (0.358 ± 0.016)	10.20 ± 0.40 (0.402 ± 0.016)				
4040	10.20 ± 0.40 (0.402 ± 0.016)	10.20 ± 0.40 (0.402 ± 0.016)				
4540	11.40 ± 0.40 (0.449 ± 0.016)	10.20 ± 0.40 (0.402 ± 0.016)				

Benefits

- High ripple current capability
- No capacitance change with respect to applied rated DC voltage
- Negligible capacitance change with respect to temperature from -55°C to +200°C
- No capacitance decay with time
- Non-polar device, minimizing installation concerns
- 100% pure matte tin-plated termination finish allowing for excellent solderability

Applications

Typical applications include high temperature detonation circuits for down-hole oil exploration and perforation.

Qualification/Certification

Industrial Grade pulse detonation products are designed to meet customer-specific testing requirements.

Environmental Compliance

Pb-Free and RoHS Compliant.



RoHS Compliant

Electrical Parameters/Characteristics

Item	Parameters/Characteristics
Operating Temperature Range	-55°C to +200°C
Capacitance Change with Reference to +25°C and 0 VDC Applied (TCC)	±30 ppm/°C
Aging Rate (Maximum % Capacitance Loss/Decade Hour)	0%
Dielectric Withstanding Voltage (DWV)	150% of rated voltage for voltage rating of < 1,000 V 120% of rated voltage for voltage rating of ≥ 1,000 V (5 ±1 seconds and charge/discharge not exceeding 50 mA)
Ultimate Voltage Breakdown (UVBD)	300% of rated voltage for voltage rating of < 1,000 V 250% of rated voltage for voltage rating of 1,000 V 240% of rated voltage for voltage rating of 1,500 V (5 ±1 seconds and charge/discharge not exceeding 50 mA)
Dissipation Factor (DF) Maximum Limit @ 25°C	0.1%
Insulation Resistance (IR) Limit @ 25°C	1000 megohm microfarads or 100 GΩ (500 VDC applied for 120 ±5 seconds @ 25°C)

To obtain IR limit, divide MΩ-μF value by the capacitance and compare to GΩ limit. Select the lower of the two limits.

Capacitance and Dissipation Factor (DF) measured under the following conditions:

1 MHz ±100 kHz and 1.0 Vrms ±0.2 V if capacitance ≤ 1,000 pF

1 kHz ±50 Hz and 1.0 Vrms ±0.2 V if capacitance > 1,000 pF

Note: When measuring capacitance it is important to ensure the set voltage level is held constant. The HP4284 and Agilent E4980 have a feature known as Automatic Level Control (ALC). The ALC feature should be switched to "ON."

Post Environmental Limits

High Temperature Life, Biased Humidity, Moisture Resistance					
Dielectric	Rated DC Voltage	Capacitance Value	Dissipation Factor (Maximum %)	Capacitance Shift	Insulation Resistance
COG	All	All	0.5	0.3% or ±0.25 pF	10% of Initial Limit

Ultimate Voltage Breakdown (UVBD) – Typical Mean Breakdown Voltage Ratings

Rated Voltage (VDC)	Breakdown Voltage/UVBD (VDC)
500	3X Rated
630	3X Rated
1,000	2.5X Rated
1,500	2.3X Rated
2,000	2X Rated

Electrical Characteristics

Current vs. Voltage

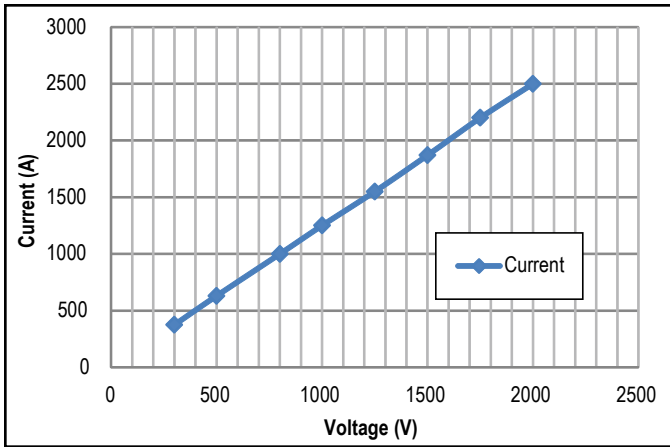

Table 1 – Pulse Detonation Series, Capacitance Range Waterfall

Case Size (in.)		2824					3040					3640					4040					4540									
Length	mm	7.10 ± 0.40					7.60 ± 0.40					9.10 ± 0.40					10.20 ± 0.40					11.40 ± 0.40									
	(in.)	(0.280 ± 0.016)					(0.300 ± 0.016)					(0.358 ± 0.016)					(0.402 ± 0.016)					(0.449 ± 0.016)									
Width	mm	6.10 ± 0.40					10.20 ± 0.40					10.20 ± 0.40					10.20 ± 0.40					10.20 ± 0.40									
	(in.)	(0.240 ± 0.016)					(0.402 ± 0.016)					(0.402 ± 0.016)					(0.402 ± 0.016)					(0.402 ± 0.016)									
Thickness Maximum	mm	2.5					2.5					2.5					2.5					2.5									
	(in.)	(0.098)					(0.098)					(0.098)					(0.098)					(0.098)									
Bandwidth	mm	0.76 ± 0.40					0.76 ± 0.40					0.76 ± 0.40					0.76 ± 0.40					0.76 ± 0.40									
	(in.)	(0.030 ± 0.016)					(0.030 ± 0.016)					(0.030 ± 0.016)					(0.030 ± 0.016)					(0.030 ± 0.016)									
Rated Voltage (VDC)		500	630	1K	1.5K	2K	500	630	1K	1.5K	2K	500	630	1K	1.5K	2K	500	630	1K	1.5K	2K	500	630	1K	1.5K	2K	500	630	1K	1.5K	2K
Voltage Code		C	B	D	F	G	C	B	D	F	G	C	B	D	F	G	C	B	D	F	G	C	B	D	F	G	C	B	D	F	G
Breakdown Voltage (VDC)		1.5K	1.8K	2.5K	3.5K	4K	1.5K	1.8K	2.5K	3.5K	4K	1.5K	1.8K	2.5K	3.5K	4K	1.5K	1.8K	2.5K	3.5K	4K	1.5K	1.8K	2.5K	3.5K	4K	1.5K	1.8K	2.5K	3.5K	4K
Capacitance	Capacitance Tolerance	Capacitance Code (Available Maximum Capacitance)¹																													
5,600pF	J = ±5% K = ±10% M = ±20%					562																									
6,800pF					682																										
8,200pF																															
0.01µF											103																				
0.012µF																															
0.015µF											153					153															
0.018µF																														183	
0.022µF					223																										
0.027µF																															
0.033µF					333																										
0.039µF																															
0.047µF											473					473															
0.056µF																															
0.062µF																															
0.068µF						683					683																			683	
0.072µF																723															
0.082µF																															
0.1µF										104																			104		
0.12µF															124																
0.15µF																													154		
Rated Voltage (VDC)		500	630	1K	1.5K	2K	500	630	1K	1.5K	2K	500	630	1K	1.5K	2K	500	630	1K	1.5K	2K	500	630	1K	1.5K	2K	500	630	1K	1.5K	2K
Voltage Code		C	B	D	F	G	C	B	D	F	G	C	B	D	F	G	C	B	D	F	G	C	B	D	F	G	C	B	D	F	G
Breakdown Voltage (VDC)		1.5K	1.8K	2.5K	3.5K	4K	1.5K	1.8K	2.5K	3.5K	4K	1.5K	1.8K	2.5K	3.5K	4K	1.5K	1.8K	2.5K	3.5K	4K	1.5K	1.8K	2.5K	3.5K	4K	1.5K	1.8K	2.5K	3.5K	4K

¹ Only maximum available CV (capacitance /voltage) values are highlighted. Lower CV values are available upon request. Please contact KEMET to discuss your specific CV requirement.

These products are protected under US Patents 7,172,985 and 7,670,981, other patents pending, and any foreign counterparts.

Table 2 – Chip Capacitor Land Pattern Design Recommendations per IPC–7351

Size Code (in)	Density Level A: Maximum (Most) Land Protrusion (mm)					Density Level B: Median (Nominal) Land Protrusion (mm)					Density Level C: Minimum (Least) Land Protrusion (mm)				
	C	Y	X	V1	V2	C	Y	X	V1	V2	C	Y	X	V1	V2
2824	3.45	1.70	6.60	9.60	7.60	3.35	1.50	6.50	8.70	7.00	3.25	1.30	6.40	8.00	6.70
3040	3.70	1.70	10.70	10.10	11.70	3.60	1.50	10.60	9.20	11.10	3.50	1.30	10.50	8.50	10.80
3640	4.45	1.70	10.70	11.60	11.70	4.35	1.50	10.60	10.70	11.10	4.25	1.30	10.50	10.00	10.80
4040	5.00	1.70	10.70	12.70	11.70	4.90	1.50	10.60	11.80	11.10	4.80	1.30	10.50	11.10	10.80
4540	5.60	1.70	10.70	13.90	11.70	5.50	1.50	10.60	13.00	11.10	5.40	1.30	10.50	12.30	10.80

Density Level A: For low-density product applications. Provides a wider process window for reflow solder processes.

Density Level B: For products with a moderate level of component density. Provides a robust solder attachment condition for reflow solder processes.

Density Level C: For high component density product applications. Before adapting the minimum land pattern variations, the user should perform qualification testing based on the conditions outlined in IPC Standard 7351 (IPC–7351).

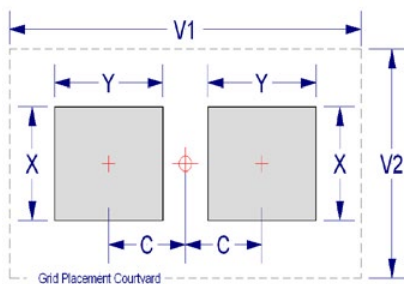

Soldering Process

Recommended Soldering Technique:

- Solder reflow only

Recommended Soldering Profile:

- KEMET recommends following the guidelines outlined in IPC/JEDEC J-STD–020

Storage and Handling

Ceramic chip capacitors should be stored in normal working environments. While the chips themselves are quite robust in other environments, solderability will be degraded by exposure to high temperatures, high humidity, corrosive atmospheres, and long term storage. In addition, packaging materials will be degraded by high temperature— reels may soften or warp and tape peel force may increase. KEMET recommends that maximum storage temperature not exceed 40°C and maximum storage humidity not exceed 70% relative humidity. Temperature fluctuations should be minimized to avoid condensation on the parts and atmospheres should be free of chlorine and sulfur bearing compounds. For optimized solderability chip stock should be used promptly, preferably within 1.5 years of receipt.

Construction

Reference	Item	Material
A	Termination System	Finish
B		Barrier Layer
C		Base Metal
D	Inner Electrode	Ni
E	Dielectric Material	CaZrO ₃

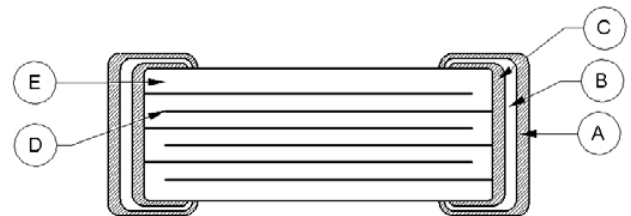

Note: Image is exaggerated in order to clearly identify all components of construction.

Capacitor Marking (Optional):

Laser marking option is not available on:

- COG, Ultra Stable X8R and Y5V dielectric devices
- EIA 0402 case size devices
- EIA 0603 case size devices with Flexible Termination option.
- KPS Commercial and Automotive grade stacked devices.

These capacitors are supplied unmarked only.

Packaging

Please contact KEMET for details regarding available packaging options.

Surface Mount Multilayer Ceramic Chip Capacitors (SMD MLCCs)
High Voltage C0G Dielectric, 500 – 3,000 VDC
(Commercial & Automotive Grade)

Overview

KEMET's high voltage surface mount MLCCs in C0G dielectric feature a 125°C maximum operating temperature and are considered "stable." The Electronics Industries Alliance (EIA) characterizes C0G dielectric as a Class I material. Components of this classification are temperature compensating and are suited for resonant circuit applications or those where Q and stability of capacitance characteristics are required. C0G exhibits no change in capacitance with respect to time and voltage and boasts a negligible change in capacitance with reference to ambient temperature. Capacitance change is limited to ±30 ppm/°C from -55°C to +125°C.

These devices exhibit low ESR at high frequencies and find conventional use as snubbers or filters in applications such as switching power supplies and lighting ballasts. Their exceptional performance at high frequencies has made high

voltage MLCCs the preferred dielectric choice of design engineers worldwide. In addition to their use in power supplies, these capacitors are widely used in industries related to automotive (hybrid), telecommunications, medical, military, aerospace, semiconductors and test/diagnostic equipment.

Automotive Grade is available for applications requiring proven, reliable performance in harsh environments. Whether under-hood or in-cabin, these capacitors are designed for mission and safety critical automotive circuits. Stricter testing protocol and inspection criteria have been established for automotive grade products in recognition of potentially harsh environmental conditions. KEMET automotive grade series capacitors meet the demanding Automotive Electronics Council's AEC-Q200 qualification requirements.

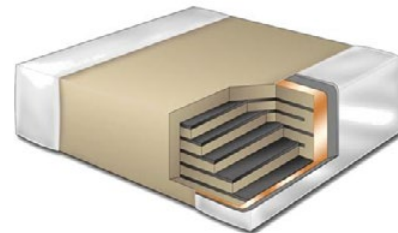

Ordering Information

C	1210	C	332	J	C	G	A	C	TU
Ceramic	Case Size (L" x W")	Specification/ Series	Capacitance Code (pF)	Capacitance Tolerance ¹	Voltage	Dielectric	Failure Rate/ Design	Termination Finish ²	Packaging/Grade (C-Spec) ³
	0805 1206 1210 1808 1812 1825 2220 2225	C = Standard	2 Significant Digits + Number of Zeros Use 9 for 1.0 – 9.9 pF Use 8 for 0.5 – .99 pF ex. 2.2 pF = 229 ex. 0.5 pF = 508	B = ±0.10 pF C = ±0.25 pF D = ±0.5 pF F = ±1% G = ±2% J = ±5% K = ±10% M = ±20%	C = 500 V B = 630 V D = 1,000 V F = 1,500 V G = 2,000 V Z = 2,500 V H = 3,000 V	G = C0G	A = N/A	C = 100% Matte Sn L = SnPb (5% minimum)	Blank = Bulk TU = 7" Reel Unmarked AUTO = Automotive Grade 7" Reel Unmarked

¹ Additional capacitance tolerance offerings may be available. Contact KEMET for details.

² SnPb termination finish option is not available on Automotive Grade product.

^{2,3} Additional termination finish options may be available. Contact KEMET for details.

³ Additional reeling or packaging options may be available. Contact KEMET for details.

Dimensions – Millimeters (Inches)

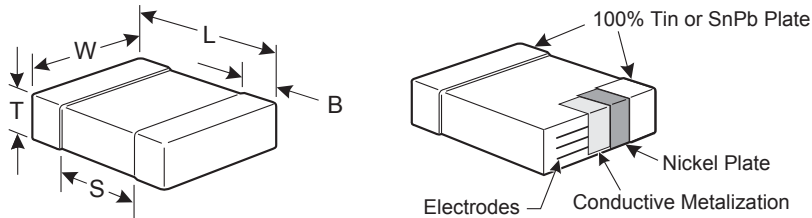

EIA Size Code	Metric Size Code	L Length	W Width	T Thickness	B Bandwidth	S Separation Minimum	Mounting Technique
0805	2012	2.00 (.079) ±0.20 (.008)	1.25 (.049) ±0.20 (.008)	See Table 2 for Thickness	0.50 (0.02) ±0.25 (.010)	0.75 (.030)	Solder Wave or Solder Reflow
1206	3216	3.20 (.126) ±0.20 (.008)	1.60 (.063) ±0.20 (.008)		0.50 (0.02) ±0.25 (.010)	N/A	
1210	3225	3.20 (.126) ±0.20 (.008)	2.50 (.098) ±0.20 (.008)		0.50 (0.02) ±0.25 (.010)		Solder Reflow Only
1808	4520	4.70 (.185) ±0.50 (.020)	2.00 (.079) ±0.20 (.008)		0.60 (.024) ±0.35 (.014)		
1812	4532	4.50 (.177) ±0.30 (.012)	3.20 (.126) ±0.30 (.012)		0.60 (.024) ±0.35 (.014)		
1825	4564	4.50 (.177) ±0.30 (.012)	6.40 (.252) ±0.40 (.016)		0.60 (.024) ±0.35 (.014)		
2220	5650	5.70 (.224) ±0.40 (.016)	5.00 (.197) ±0.40 (.016)		0.60 (.024) ±0.35 (.014)		
2225	5664	5.60 (.220) ±0.40 (.016)	6.40 (.248) ±0.40 (.016)		0.60 (.024) ±0.35 (.014)		

Benefits

- -55°C to +125°C operating temperature range
- RoHS Compliant
- EIA 0805, 1206, 1210, 1808, 1812, 1825, 2220, and 2225 case sizes
- DC voltage ratings of 500 V, 630 V, 1 KV, 1.5 KV, 2 KV, 2.5 KV, and 3 KV
- Capacitance offerings ranging from 1 pF to 0.039 µF
- Available capacitance tolerances of ±0.10 pF, ±0.25 pF, ±0.5 pF, ±1%, ±2%, ±5%, ±10%, and ±20%
- No piezoelectric noise
- Extremely low ESR and ESL
- High thermal stability
- High ripple current capability
- Preferred capacitance solution at line frequencies & into the MHz range
- No capacitance change with respect to applied rated DC voltage
- Negligible capacitance change with respect to temperature from -55°C to +125°C
- No capacitance decay with time
- Non-polar device, minimizing installation concerns
- Commercial & Automotive (AEC-Q200) grades available
- 100% pure matte tin-plated termination finish allowing for excellent solderability
- SnPb plated termination finish option available upon request (5% minimum)

Applications

Typical applications include switch mode power supplies (input filters, resonators, tank circuits, snubbed circuits, output filters), high voltage coupling and DC blocking, lighting ballasts, voltage multiplier circuits, DC/DC converters and coupling capacitors in Ćuk converters. Markets include power supply, LCD fluorescent backlight ballasts, HID lighting, telecom equipment, industrial and medical equipment/control, LAN/WAN interface, analog and digital modems, and automotive.

Qualification/Certification

Commercial Grade products are subject to internal qualification. Details regarding test methods and conditions are referenced in Table 4, Performance & Reliability.

Automotive Grade products meet or exceed the requirements outlined by the Automotive Electronics Council. Details regarding test methods and conditions are referenced in document AEC-Q200, Stress Test Qualification for Passive Components. For additional information regarding the Automotive Electronics Council and AEC-Q200, please visit their website at www.aecouncil.com.

Environmental Compliance

RoHS Compliant (excluding SnPb termination finish option).



RoHS Compliant

Electrical Parameters/Characteristics

Item	Parameters/Characteristics
Operating Temperature Range	-55°C to +125°C
Capacitance Change with Reference to +25°C and 0 VDC Applied (TCC)	±30 ppm/°C
Aging Rate (Maximum % Capacitance Loss/Decade Hour)	0%
Dielectric Withstanding Voltage (DWV)	150% of rated voltage for voltage rating of < 1,000 V 120% of rated voltage for voltage rating of ≥ 1,000 V (5 ±1 seconds and charge/discharge not exceeding 50 mA)
Dissipation Factor (DF) Maximum Limit @ 25°C	0.1%
Insulation Resistance (IR) Limit @ 25°C	1,000 megohm microfarads or 100 GΩ (500 VDC applied for 120 ±5 seconds @ 25°C)

To obtain IR limit, divide MΩ-μF value by the capacitance and compare to GΩ limit. Select the lower of the two limits.

Capacitance and dissipation factor (DF) measured under the following conditions:

1 MHz ±100 kHz and 1.0 Vrms ±0.2 V if capacitance ≤ 1,000 pF

1 kHz ±50 Hz and 1.0 Vrms ±0.2 V if capacitance > 1,000 pF

Note: When measuring capacitance it is important to ensure the set voltage level is held constant. The HP4284 and Agilent E4980 have a feature known as Automatic Level Control (ALC). The ALC feature should be switched to "ON."

Post Environmental Limits

High Temperature Life, Biased Humidity, Moisture Resistance					
Dielectric	Rated DC Voltage	Capacitance Value	Dissipation Factor (Maximum %)	Capacitance Shift	Insulation Resistance
COG	All	All	0.5	0.3% or ±0.25 pF	10% of Initial Limit

Table 1A – Capacitance Range/Selection Waterfall (0805 – 1808 Case Sizes)

Capacitance	Cap Code	Case Size / Series			C0805C			C1206C					C1210C					C1808C											
		Voltage Code			C	B	D	C	B	D	F	G	C	B	D	F	G	C	B	D	F	G	Z	H					
		Rated Voltage (VDC)			500	630	1000	500	630	1000	1500	2000	500	630	1000	1500	2000	500	630	1000	1500	2000	2500	3000					
		Capacitance Tolerance			Product Availability and Chip Thickness Codes See Table 2 for Chip Thickness Dimensions																								
1.0 - 9.1 pF*	109 - 919*	B	C	D	F	G	J	K	M	DG	DG	DG	EG	EG	EG	EG	EG	FM	FM	FM	FM	FM	LB	LB	LB	LB	LB	LB	LB
10 pF - 47pF*	100 - 470*				F	G	J	K	M	DG	DG	DG	EF	EF	EF	EG	EG	FM	FM	FM	FM	FM	LB	LB	LB	LB	LB	LB	LB
51 pF	510				F	G	J	K	M	DG	DG	DG	EF	EF	EF	EG	EG	FM	FM	FM	FM	FM	LB	LB	LB	LB	LB	LB	LB
56 pF	560				F	G	J	K	M	DG	DG	DG	EF	EF	EF	EG	EG	FM	FM	FM	FM	FM	LB	LB	LB	LB	LB	LB	LB
62 pF	620				F	G	J	K	M	DG	DG	DG	EF	EF	EF	EG	EG	FM	FM	FM	FM	FM	LB	LB	LB	LB	LB	LB	LB
68 pF	680				F	G	J	K	M	DG	DG	DG	EF	EF	EF	EG	EG	FM	FM	FM	FM	FM	LB	LB	LB	LB	LB	LB	LB
75 pF	750				F	G	J	K	M	DG	DG	DG	EF	EF	EF	EG	EG	FM	FM	FM	FM	FM	LB	LB	LB	LB	LB	LB	LB
82 pF	820				F	G	J	K	M	DG	DG	DG	EF	EF	EF	EG	EG	FM	FM	FM	FM	FM	LB	LB	LB	LB	LB	LB	LB
91 pF	910				F	G	J	K	M	DG	DG	DG	EF	EF	EF	EG	EG	FM	FM	FM	FM	FM	LB	LB	LB	LB	LB	LB	LB
100 pF	101				F	G	J	K	M	DG	DG	DG	EF	EF	EF	EG	EG	FM	FM	FM	FM	FM	LB	LB	LB	LB	LB	LC	LB
110 pF	111				F	G	J	K	M	DG	DG	DG	EF	EF	EF	EG	EG	FM	FM	FM	FM	FM	LB	LB	LB	LB	LB	LC	LB
120 pF	121				F	G	J	K	M	DG	DG	DG	EF	EF	EF	EG	EG	FG	FG	FG	FM	FM	LA	LA	LA	LA	LA	LB	LC
130 pF	131				F	G	J	K	M	DG	DG	DG	EF	EF	EF	EG	EG	FG	FG	FG	FM	FM	LA	LA	LA	LA	LA	LB	LC
150 pF	151				F	G	J	K	M	DG	DG	DG	EF	EF	EF	EG	EG	FG	FG	FG	FM	FM	LA	LA	LA	LA	LA	LB	LC
160 pF	161				F	G	J	K	M	DG	DG	DG	EF	EF	EF	EG	EG	FG	FG	FG	FM	FM	LA	LA	LA	LA	LA	LC	LC
180 pF	181				F	G	J	K	M	DG	DG	DG	EF	EF	EF	EG	EG	FG	FG	FG	FM	FM	LA	LA	LA	LA	LA	LC	LC
200 pF	201				F	G	J	K	M	DG	DG	DG	EF	EG	EG	EG	EG	FG	FG	FG	FM	FM	LA	LA	LA	LA	LA	LC	LC
220 pF	221				F	G	J	K	M	DG	DG	DG	EF	EG	EG	EG	EG	FG	FG	FG	FM	FM	LA	LA	LA	LA	LA	LC	LC
240 pF	241				F	G	J	K	M	DG	DG	DG	EF	EG	EG	EG	EG	FG	FG	FG	FM	FM	LA	LA	LA	LA	LB	LC	LC
270 pF	271				F	G	J	K	M	DG	DG	DG	EF	EG	EG	EG	EG	FG	FG	FG	FK	FK	LA	LA	LA	LA	LB	LC	LC
300 pF	301				F	G	J	K	M	DG	DG		EF	EG	EG	EG		FG	FG	FG	FK	FK	LA	LA	LA	LB	LC	LC	
330 pF	331				F	G	J	K	M	DG	DG		EF	EG	EG	EG		FG	FG	FG	FK	FK	LA	LA	LA	LB	LC	LC	
360 pF	361				F	G	J	K	M	DG	DG		EG	EG	EG	EG		FG	FG	FG	FK	FS	LA	LA	LA	LB	LA	LC	LC
390 pF	391				F	G	J	K	M	DG	DG		EG	EG	EG	EG		FG	FG	FG	FK	FS	LA	LA	LA	LB	LA	LC	LC
430 pF	431				F	G	J	K	M	DG	DG		EG	EG	EG	EG		FG	FM	FM	FS	FS	LA	LB	LB	LC	LA		
470 pF	471				F	G	J	K	M	DG	DG		EG	EG	EG	EG		FG	FM	FM	FS	FS	LA	LB	LB	LC	LA		
510 pF	511				F	G	J	K	M	DG	DG		EG	EG	EG	EG		FG	FM	FM	FS	FS	LA	LB	LB	LC	LB		
560 pF	561				F	G	J	K	M	DG	DG		EG	EG	EG	EG		FG	FM	FM	FS	FS	LA	LB	LB	LC	LB		
620 pF	621				F	G	J	K	M	DG			EG	EG	EG			FG	FM	FM	FS	FS	LA	LB	LB	LA	LC		
680 pF	681				F	G	J	K	M	DG			EG	EG	EG			FG	FM	FM	FS	FS	LB	LB	LB	LA	LC		
750 pF	751				F	G	J	K	M	DG			EG	EF	EG			FG	FM	FM	FM		LB	LB	LB	LA			
820 pF	821				F	G	J	K	M	DG			EG	EF	EG			FG	FM	FM	FM		LB	LB	LB	LA			
910 pF	911				F	G	J	K	M				EG	EF	EG			FM	FM	FM	FY		LB	LB	LB	LA			
1,000 pF	102				F	G	J	K	M				EG	EF	EG			FM	FM	FM	FY		LB	LB	LB	LB			
1,100 pF	112				F	G	J	K	M				EF	EG				FM	FK	FK	FS		LC	LC	LC	LB			
1,200 pF	122				F	G	J	K	M				EF	EG				FM	FK	FK	FS		LC	LC	LC	LC			
1,300 pF	132				F	G	J	K	M				EF	EG				FM	FS	FS			LC	LC	LC	LC			
1,500 pF	152				F	G	J	K	M				EF	EG				FK	FS	FS			LC	LC	LC	LC			
1,600 pF	162				F	G	J	K	M				EF	EG				FK	FS	FS			LC	LC	LC	LC			
1,800 pF	182				F	G	J	K	M				EF	EG				FK	FS	FS			LC	LC	LC	LC			
2,000 pF	202				F	G	J	K	M				EG					FK	FL	FS			LC	LA	LB				
2,200 pF	222				F	G	J	K	M				EG					FK	FL	FS			LC	LA	LB				
2,400 pF	242				F	G	J	K	M				EG					FS	FL	FS			LC	LA	LB				
2,700 pF	272				F	G	J	K	M				EG					FS	FL	FS			LC	LA	LC				
3,000 pF	302				F	G	J	K	M									FS	FL				LA	LA					
3,300 pF	332				F	G	J	K	M									FS	FM				LA	LA					
3,600 pF	362				F	G	J	K	M									FL	FM				LA	LB					
3,900 pF	392				F	G	J	K	M									FL	FY				LA	LB					
4,300 pF	432				F	G	J	K	M									FM	FY				LA	LC					
4,700 pF	472				F	G	J	K	M									FM	FY				LA	LC					
5,100 pF	512				F	G	J	K	M									FY	FS				LA						
Capacitance	Cap Code	Rated Voltage (VDC)			C0805C			C1206C					C1210C					C1808C											
		Voltage Code			C	B	D	C	B	D	F	G	C	B	D	F	G	C	B	D	F	G	Z	H					
		Case Size / Series			C0805C			C1206C					C1210C					C1808C											

*Capacitance range Includes E24 decade values only. (i.e., 10, 11, 12, 13, 15, 16, 18, 20, 22, 24, 27, 30, 33, 36, 39, 43, 47, 51, 56, 62, 68, 75, 82 and 91)
 KEMET reserves the right to substitute product with an improved temperature characteristic, tighter capacitance tolerance and/or higher voltage capability within the same form factor (configuration and dimensions).
 These products are protected under US Patents 7,172,985 and 7,670,981, other patents pending, and any foreign counterparts.

Table 2 – Chip Thickness/Packaging Quantities

Thickness Code	Case Size	Thickness ± Range (mm)	Paper Quantity		Plastic Quantity	
			7" Reel	13" Reel	7" Reel	13" Reel
DG	0805	1.25 ± 0.15	0	0	2,500	10,000
EF	1206	1.20 ± 0.15	0	0	2,500	10,000
EG	1206	1.60 ± 0.15	0	0	2,000	8,000
FG	1210	1.25 ± 0.15	0	0	2,500	10,000
FL	1210	1.40 ± 0.15	0	0	2,000	8,000
FM	1210	1.70 ± 0.20	0	0	2,000	8,000
FY	1210	2.00 ± 0.20	0	0	2,000	8,000
FK	1210	2.10 ± 0.20	0	0	2,000	8,000
FS	1210	2.50 ± 0.30	0	0	1,000	4,000
LA	1808	1.40 ± 0.15	0	0	1,000	4,000
LB	1808	1.60 ± 0.15	0	0	1,000	4,000
LC	1808	2.00 ± 0.15	0	0	1,000	4,000
GH	1812	1.40 ± 0.15	0	0	1,000	4,000
GK	1812	1.60 ± 0.20	0	0	1,000	4,000
GM	1812	2.00 ± 0.20	0	0	500	2,000
GO	1812	2.50 ± 0.20	0	0	500	2,000
HE	1825	1.40 ± 0.15	0	0	1,000	4,000
HG	1825	1.60 ± 0.20	0	0	1,000	4,000
HJ	1825	2.00 ± 0.20	0	0	500	2,000
HK	1825	2.50 ± 0.20	0	0	500	2,000
JE	2220	1.40 ± 0.15	0	0	1,000	4,000
JK	2220	1.60 ± 0.20	0	0	1,000	4,000
JL	2220	2.00 ± 0.20	0	0	500	2,000
JN	2220	2.50 ± 0.20	0	0	500	2,000
KE	2225	1.40 ± 0.15	0	0	1,000	4,000
KF	2225	1.60 ± 0.20	0	0	1,000	4,000
KH	2225	2.00 ± 0.20	0	0	500	2,000
KJ	2225	2.50 ± 0.20	0	0	500	2,000
Thickness Code	Case Size	Thickness ± Range (mm)	7" Reel	13" Reel	7" Reel	13" Reel
			Paper Quantity		Plastic Quantity	

Package quantity based on finished chip thickness specifications.

Table 3 – Chip Capacitor Land Pattern Design Recommendations per IPC–7351

EIA Size Code	Metric Size Code	Density Level A: Maximum (Most) Land Protrusion (mm)					Density Level B: Median (Nominal) Land Protrusion (mm)					Density Level C: Minimum (Least) Land Protrusion (mm)				
		C	Y	X	V1	V2	C	Y	X	V1	V2	C	Y	X	V1	V2
0805	2012	1.00	1.35	1.55	4.40	2.60	0.90	1.15	1.45	3.50	2.00	0.75	0.95	1.35	2.80	1.70
1206	3216	1.60	1.35	1.90	5.60	2.90	1.50	1.15	1.80	4.70	2.30	1.40	0.95	1.70	4.00	2.00
1210	3225	1.60	1.35	2.80	5.65	3.80	1.50	1.15	2.70	4.70	3.20	1.40	0.95	2.60	4.00	2.90
1210 ¹	3225	1.50	1.60	2.90	5.60	3.90	1.40	1.40	2.80	4.70	3.30	1.30	1.20	2.70	4.00	3.00
1808	4520	2.30	1.75	2.30	7.40	3.30	2.20	1.55	2.20	6.50	2.70	2.10	1.35	2.10	5.80	2.40
1812	4532	2.15	1.60	3.60	6.90	4.60	2.05	1.40	3.50	6.00	4.00	1.95	1.20	3.40	5.30	3.70
1825	4564	2.15	1.60	6.90	6.90	7.90	2.05	1.40	6.80	6.00	7.30	1.95	1.20	6.70	5.30	7.00
2220	5650	2.75	1.70	5.50	8.20	6.50	2.65	1.50	5.40	7.30	5.90	2.55	1.30	5.30	6.60	5.60
2225	5664	2.70	1.70	6.90	8.10	7.90	2.60	1.50	6.80	7.20	7.30	2.50	1.30	6.70	6.50	7.00

¹ Only for capacitance values $\geq 22 \mu\text{F}$

Density Level A: For low-density product applications. Recommended for wave solder applications and provides a wider process window for reflow solder processes. KEMET only recommends wave soldering of EIA 0603, 0805 and 1206 case sizes.

Density Level B: For products with a moderate level of component density. Provides a robust solder attachment condition for reflow solder processes.

Density Level C: For high component density product applications. Before adapting the minimum land pattern variations the user should perform qualification testing based on the conditions outlined in IPC Standard 7351 (IPC–7351).

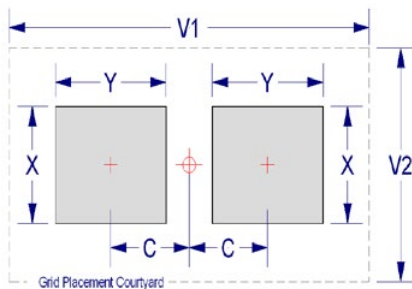

Soldering Process

Recommended Soldering Technique:

- Solder wave or solder reflow for EIA case sizes 0603, 0805 and 1206
- All other EIA case sizes are limited to solder reflow only

Recommended Soldering Profile:

- KEMET recommends following the guidelines outlined in IPC / JEDEC J–STD–020

Table 4 – Performance & Reliability: Test Methods and Conditions

Stress	Reference	Test or Inspection Method
Terminal Strength	JIS-C-6429	Appendix 1, Note: Force of 1.8 kg for 60 seconds.
Board Flex	JIS-C-6429	Appendix 2, Note: Standard termination system – 2.0 mm (minimum) for all except 3 mm for COG. Flexible termination system – 3.0 mm (minimum).
Solderability	J-STD-002	Magnification 50 X. Conditions:
		a) Method B, 4 hours @ 155°C, dry heat @ 235°C
		b) Method B @ 215°C category 3
		c) Method D, category 3 @ 260°C
Temperature Cycling	JESD22 Method JA-104	1,000 cycles (-55°C to +125°C). Measurement at 24 hours +/- 2 hours after test conclusion.
Biased Humidity	MIL-STD-202 Method 103	Load Humidity: 1,000 hours 85°C/85% RH and 200 VDC maximum. Add 100 K ohm resistor. Measurement at 24 hours +/- 2 hours after test conclusion.
		Low Volt Humidity: 1,000 hours 85°C/85% RH and 1.5 V. Add 100 K ohm resistor. Measurement at 24 hours +/- 2 hours after test conclusion.
Moisture Resistance	MIL-STD-202 Method 106	t = 24 hours/cycle. Steps 7a and 7b not required. Unpowered. Measurement at 24 hours +/- 2 hours after test conclusion.
Thermal Shock	MIL-STD-202 Method 107	-55°C/+125°C. Note: Number of cycles required – 300. Maximum transfer time – 20 seconds. Dwell time – 15 minutes. Air – Air.
High Temperature Life	MIL-STD-202 Method 108	1,000 hours at 125°C (85°C for X5R, Z5U and Y5V) with 1.2 X rated voltage applied.
Storage Life	MIL-STD-202 Method 108	150°C, 0 VDC for 1,000 hours.
Vibration	MIL-STD-202 Method 204	5 g's for 20 min., 12 cycles each of 3 orientations. Note: Use 8" X 5" PCB 0.031" thick 7 secure points on one long side and 2 secure points at corners of opposite sides. Parts mounted within 2" from any secure point. Test from 10 – 2,000 Hz
Mechanical Shock	MIL-STD-202 Method 213	Figure 1 of Method 213, Condition F.
Resistance to Solvents	MIL-STD-202 Method 215	Add aqueous wash chemical, OKEM Clean or equivalent.

Storage and Handling

Ceramic chip capacitors should be stored in normal working environments. While the chips themselves are quite robust in other environments, solderability will be degraded by exposure to high temperatures, high humidity, corrosive atmospheres, and long term storage. In addition, packaging materials will be degraded by high temperature– reels may soften or warp and tape peel force may increase. KEMET recommends that maximum storage temperature not exceed 40°C and maximum storage humidity not exceed 70% relative humidity. Temperature fluctuations should be minimized to avoid condensation on the parts and atmospheres should be free of chlorine and sulfur bearing compounds. For optimized solderability chip stock should be used promptly, preferably within 1.5 years of receipt.

Construction

Reference	Item	Material
A	Termination System	Finish 100% Matte Sn SnPb (5% min)
B		Barrier Layer Ni
C		Base Metal Cu
D	Inner Electrode	Ni
E	Dielectric Material	CaZrO ₃

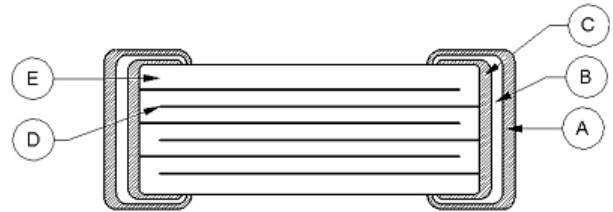

Note: Image is exaggerated in order to clearly identify all components of construction.

Capacitor Marking (Optional):

Laser marking option is not available on:

- COG, Ultra Stable X8R and Y5V dielectric devices
- EIA 0402 case size devices
- EIA 0603 case size devices with Flexible Termination option.
- KPS Commercial and Automotive grade stacked devices.

These capacitors are supplied unmarked only.

High Voltage X7R Dielectric, 500 – 3,000 VDC (Commercial & Automotive Grade)

Overview

KEMET's high voltage surface mount MLCCs in X7R Dielectric feature a 125°C maximum operating temperature and are considered "temperature stable." The Electronics Industries Alliance (EIA) characterizes X7R dielectric as a Class II material. Components of this classification are fixed, ceramic dielectric capacitors suited for bypass and decoupling applications or for frequency discriminating circuits where Q and stability of capacitance characteristics are not critical. X7R exhibits a predictable change in capacitance with respect to time and voltage and boasts a minimal change in capacitance with reference to ambient temperature. Capacitance change is limited to $\pm 15\%$ from -55°C to +125°C.

Available in a variety of case sizes and industry leading CV values (capacitance/voltage), these devices exhibit low leakage current and low ESR at high frequencies. Conventional uses include both snubbers and filters in applications such as switching power supplies and lighting ballasts. Their exceptional

performance at high frequencies has made high voltage MLCC's the preferred dielectric choice of design engineers worldwide. In addition to their use in power supplies, these capacitors are widely used in industries related to automotive (hybrid), telecommunications, medical, military, aerospace, semiconductors and test/diagnostic equipment.

Automotive Grade is available for applications requiring proven, reliable performance in harsh environments. Whether under-hood or in-cabin, these capacitors are designed for mission and safety critical automotive circuits. Stricter testing protocol and inspection criteria have been established for automotive grade products in recognition of potentially harsh environmental conditions. KEMET automotive grade series capacitors meet the demanding Automotive Electronics Council's AEC-Q200 qualification requirements.

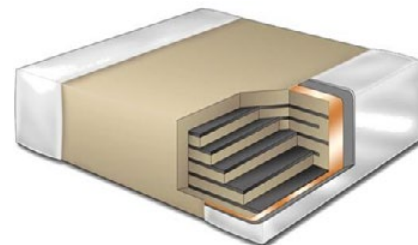

Ordering Information

C	1210	C	154	K	C	R	A	C	TU
Ceramic	Case Size (L" x W")	Specification/ Series	Capacitance Code (pF)	Capacitance Tolerance	Voltage	Dielectric	Failure Rate/ Design	Termination Finish ¹	Packaging/Grade (C-Spec) ²
	0805 1206 1210 1808 1812 1825 2220 2225	C = Standard	2 Significant Digits + Number of Zeros	J = $\pm 5\%$ K = $\pm 10\%$ M = $\pm 20\%$	C = 500 V B = 630 V D = 1,000 V F = 1,500 V G = 2,000 V Z = 2,500 V H = 3,000 V	R = X7R	A = N/A	C = 100% Matte Sn L = SnPb (5% minimum)	Blank = Bulk TU = 7" Reel Unmarked TM = 7" Reel Marked
								C = 100% Matte Sn	AUTO = Automotive Grade 7" Reel Unmarked

¹ Additional termination finish options may be available. Contact KEMET for details.

^{1,2} SnPb termination finish option is not available on Automotive Grade product.

² Additional reeling or packaging options may be available. Contact KEMET for details.

Dimensions – Millimeters (Inches)

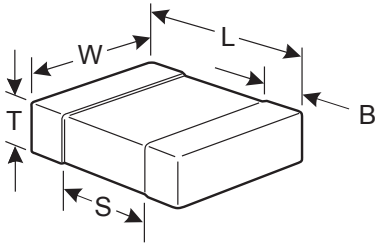

EIA Size Code	Metric Size Code	L Length	W Width	T Thickness	B Bandwidth	S Separation Minimum	Mounting Technique
0805	2012	2.00 (.079) ± 0.20 (.008)	1.25 (.049) ± 0.20 (.008)	See Table 2 for Thickness	0.50 (0.02) ± 0.25 (.010)	0.75 (.030)	Solder Wave or Solder Reflow
1206	3216	3.20 (.126) ± 0.20 (.008)	1.60 (.063) ± 0.20 (.008)		0.50 (0.02) ± 0.25 (.010)	N/A	
1210	3225	3.20 (.126) ± 0.20 (.008)	2.50 (.098) ± 0.20 (.008)		0.50 (0.02) ± 0.25 (.010)		Solder Reflow Only
1808	4520	4.70 (.185) ± 0.50 (.020)	2.00 (.079) ± 0.20 (.008)		0.60 (.024) ± 0.35 (.014)		
1812	4532	4.50 (.177) ± 0.30 (.012)	3.20 (.126) ± 0.30 (.012)		0.60 (.024) ± 0.35 (.014)		
1825	4564	4.50 (.177) ± 0.30 (.012)	6.40 (.252) ± 0.40 (.016)		0.60 (.024) ± 0.35 (.014)		
2220	5650	5.70 (.224) ± 0.40 (.016)	5.00 (.197) ± 0.40 (.016)		0.60 (.024) ± 0.35 (.014)		
2225	5664	5.60 (.220) ± 0.40 (.016)	6.40 (.248) ± 0.40 (.016)		0.60 (.024) ± 0.35 (.014)		

Benefits

- -55°C to +125°C operating temperature range
- Industry-leading CV values
- Exceptional performance at high frequencies
- Pb-Free and RoHS Compliant
- EIA 0805, 1206, 1210, 1808, 1812, 1825, 2220, and 2225 case sizes
- DC voltage ratings of 500 V, 630 V, 1 KV, 1.5 KV, 2 KV, 2.5 KV, and 3 KV
- Capacitance offerings ranging from 10 pF to 0.33 µF
- Available capacitance tolerances of ±5%, ±10%, and ±20%
- Low ESR and ESL
- Non-polar device, minimizing installation concerns
- Commercial and Automotive (AEC-Q200) grades available
- 100% pure matte tin-plated termination finish allowing for excellent solderability
- SnPb plated termination finish option available upon request (5% minimum)

Applications

Typical applications include switch mode power supplies (input filters, resonators, tank circuits, snubber circuits, output filters), high voltage coupling and DC blocking, lighting ballasts, voltage multiplier circuits, DC/DC converters and coupling capacitors in Ćuk converters. Markets include power supply, LCD fluorescent backlight ballasts, HID lighting, telecom equipment, industrial and medical equipment/control, LAN/WAN interface, analog and digital modems, and automotive (electric and hybrid vehicles, charging stations and lighting) applications.

Application Note

X7R dielectric is not recommended for AC line filtering or pulse applications. These capacitors and/or the assembled circuit board containing these capacitors may require a protective surface coating to prevent external surface arcing.

Qualification/Certification

Commercial Grade products are subject to internal qualification. Details regarding test methods and conditions are referenced in Table 4, Performance & Reliability.

Automotive Grade products meet or exceed the requirements outlined by the Automotive Electronics Council. Details regarding test methods and conditions are referenced in document AEC-Q200, Stress Test Qualification for Passive Components. For additional information regarding the Automotive Electronics Council and AEC-Q200, please visit their website at www.aecouncil.com.

Environmental Compliance

Pb-Free and RoHS Compliant (excluding SnPb termination finish option).



RoHS Compliant

Electrical Parameters/Characteristics

Item	Parameters/Characteristics
Operating Temperature Range	-55°C to +125°C
Capacitance Change with Reference to +25°C and 0 VDC Applied (TCC)	±15%
Aging Rate (Maximum % Capacitance Loss/Decade Hour)	3.0%
Dielectric Withstanding Voltage (DWV)	150% of rated voltage for voltage rating of < 1,000 V 120% of rated voltage for voltage rating of ≥ 1,000 V (5 ±1 second and charge/discharge not exceeding 50 mA)
Dissipation Factor (DF) Maximum Limit @ 25°C	2.5%
Insulation Resistance (IR) Limit @ 25°C	See Insulation Resistance Limit Table (500 VDC applied for 120 ±5 seconds @ 25°C)

Regarding aging rate: Capacitance measurements (including tolerance) are indexed to a referee time of 1,000 hours.

To obtain IR limit, divide MΩ-μF value by the capacitance and compare to GΩ limit. Select the lower of the two limits.

Capacitance and dissipation factor (DF) measured under the following conditions:

1 kHz ±50 Hz and 1.0 ±0.2 Vrms if capacitance ≤ 10 μF

120 Hz ±10 Hz and 0.5 ±0.1 Vrms if capacitance > 10 μF

Note: When measuring capacitance it is important to ensure the set voltage level is held constant. The HP4284 and Agilent E4980 have a feature known as Automatic Level Control (ALC). The ALC feature should be switched to "ON."

Post Environmental Limits

High Temperature Life, Biased Humidity, Moisture Resistance					
Dielectric	Rated DC Voltage	Capacitance Value	Dissipation Factor (Maximum %)	Capacitance Shift	Insulation Resistance
X7R	> 25	All	3.0	±20%	10% of Initial Limit
	16/25		5.0		
	< 16		7.5		

Insulation Resistance Limit Table (X7R Dielectric)

EIA Case Size	1,000 Megohm Microfarads or 100 GΩ	100 Megohm Microfarads or 10 GΩ
0805	< 0.0039 μF	≥ 0.0039 μF
1206	< 0.012 μF	≥ 0.012 μF
1210	< 0.033 μF	≥ 0.033 μF
1808	< 0.018 μF	≥ 0.018 μF
1812	< 0.027 μF	≥ 0.027 μF
≥ 1825	All	All

Table 1A – Capacitance Range/Selection Waterfall (0805 – 1812 Case Sizes)

Capacitance	Cap Code	Case Size / Series		C0805C			C1206C					C1210C					C1808C						C1812C														
		Voltage Code		C	B	D	C	B	D	F	G	C	B	D	F	G	C	B	D	F	G	Z	H	C	B	D	F	G	Z	H							
		Rated Voltage (VDC)		500	630	1000	500	630	1000	1500	2000	500	630	1000	1500	2000	500	630	1000	1500	2000	2500	3000	500	630	1000	1500	2000	2500	3000							
		Capacitance Tolerance		Product Availability and Chip Thickness Codes - See Table 2 for Chip Thickness Dimensions																																	
10 pF	100	J	K	M	DG	DG	DG	EG	EG	EG	EG	EG	FM	FM	FM	FM	FM	LB	LB	LB	LB	LB	LB	LB	LB	LB	LB	LB	LB	GK	GK	GK	GK	GK	GK	GK	GK
11 pF	110	J	K	M	DG	DG	DG	EG	EG	EG	EG	EG	FM	FM	FM	FM	FM	LB	LB	LB	LB	LB	LB	LB	LB	LB	LB	LB	LB	GK	GK	GK	GK	GK	GK	GK	GK
12 pF	120	J	K	M	DG	DG	DG	EG	EG	EG	EG	EG	FM	FM	FM	FM	FM	LB	LB	LB	LB	LB	LB	LB	LB	LB	LB	LB	LB	GK	GK	GK	GK	GK	GK	GK	GK
13 pF	130	J	K	M	DG	DG	DG	EG	EG	EG	EG	EG	FM	FM	FM	FM	FM	LB	LB	LB	LB	LB	LB	LB	LB	LB	LB	LB	LB	GK	GK	GK	GK	GK	GK	GK	GK
15 pF	150	J	K	M	DG	DG	DG	EG	EG	EG	EG	EG	FM	FM	FM	FM	FM	LB	LB	LB	LB	LB	LB	LB	LB	LB	LB	LB	LB	GK	GK	GK	GK	GK	GK	GK	GK
16 pF	160	J	K	M	DG	DG	DG	EG	EG	EG	EG	EG	FM	FM	FM	FM	FM	LB	LB	LB	LB	LB	LB	LB	LB	LB	LB	LB	LB	GK	GK	GK	GK	GK	GK	GK	GK
18 pF	180	J	K	M	DG	DG	DG	EG	EG	EG	EG	EG	FM	FM	FM	FM	FM	LB	LB	LB	LB	LB	LB	LB	LB	LB	LB	LB	LB	GK	GK	GK	GK	GK	GK	GK	GK
20 pF	200	J	K	M	DG	DG	DG	EG	EG	EG	EG	EG	FM	FM	FM	FM	FM	LB	LB	LB	LB	LB	LB	LB	LB	LB	LB	LB	LB	GK	GK	GK	GK	GK	GK	GK	GK
22 pF	220	J	K	M	DG	DG	DG	EG	EG	EG	EG	EG	FM	FM	FM	FM	FM	LB	LB	LB	LB	LB	LB	LB	LB	LB	LB	LB	LB	GK	GK	GK	GK	GK	GK	GK	GK
24 pF	240	J	K	M	DG	DG	DG	EG	EG	EG	EG	EG	FM	FM	FM	FM	FM	LB	LB	LB	LB	LB	LB	LB	LB	LB	LB	LB	LB	GK	GK	GK	GK	GK	GK	GK	GK
27 pF	270	J	K	M	DG	DG	DG	EG	EG	EG	EG	EG	FM	FM	FM	FM	FM	LB	LB	LB	LB	LB	LB	LB	LB	LB	LB	LB	LB	GK	GK	GK	GK	GK	GK	GK	GK
30 pF	300	J	K	M	DG	DG	DG	EG	EG	EG	EG	EG	FM	FM	FM	FM	FM	LB	LB	LB	LB	LB	LB	LB	LB	LB	LB	LB	LB	GK	GK	GK	GK	GK	GK	GK	GK
33 pF	330	J	K	M	DG	DG	DG	EG	EG	EG	EG	EG	FM	FM	FM	FM	FM	LB	LB	LB	LB	LB	LB	LB	LB	LB	LB	LB	LB	GK	GK	GK	GK	GK	GK	GK	GK
36 pF	360	J	K	M	DG	DG	DG	EG	EG	EG	EG	EG	FM	FM	FM	FM	FM	LB	LB	LB	LB	LB	LB	LB	LB	LB	LB	LB	LB	GK	GK	GK	GK	GK	GK	GK	GK
39 pF	390	J	K	M	DG	DG	DG	EG	EG	EG	EG	EG	FM	FM	FM	FM	FM	LB	LB	LB	LB	LB	LB	LB	LB	LB	LB	LB	LB	GK	GK	GK	GK	GK	GK	GK	GK
43 pF	430	J	K	M	DG	DG	DG	EG	EG	EG	EG	EG	FM	FM	FM	FM	FM	LB	LB	LB	LB	LB	LB	LB	LB	LB	LB	LB	LB	GK	GK	GK	GK	GK	GK	GK	GK
47 pF	470	J	K	M	DG	DG	DG	EG	EG	EG	EG	EG	FM	FM	FM	FM	FM	LB	LB	LB	LB	LB	LB	LB	LB	LB	LB	LB	LB	GK	GK	GK	GK	GK	GK	GK	GK
51 pF	510	J	K	M	DG	DG	DG	EF	EF	EF	EG	EG	FM	FM	FM	FM	FM	LB	LB	LB	LB	LB	LB	LB	LB	LB	LB	LB	LB	GK	GK	GK	GK	GK	GK	GK	GK
56 pF	560	J	K	M	DG	DG	DG	EF	EF	EF	EG	EG	FM	FM	FM	FM	FM	LB	LB	LB	LB	LB	LB	LB	LB	LB	LB	LB	LB	GK	GK	GK	GK	GK	GK	GK	GK
62 pF	620	J	K	M	DG	DG	DG	EF	EF	EF	EG	EG	FM	FM	FM	FM	FM	LB	LB	LB	LB	LB	LB	LB	LB	LB	LB	LB	LB	GK	GK	GK	GK	GK	GK	GK	GK
68 pF	680	J	K	M	DG	DG	DG	EF	EF	EF	EG	EG	FM	FM	FM	FM	FM	LB	LB	LB	LB	LB	LB	LB	LB	LB	LB	LB	LB	GK	GK	GK	GK	GK	GK	GK	GK
75 pF	750	J	K	M	DG	DG	DG	EF	EF	EF	EG	EG	FM	FM	FM	FM	FM	LB	LB	LB	LB	LB	LB	LB	LB	LB	LB	LB	LB	GK	GK	GK	GK	GK	GK	GK	GK
82 pF	820	J	K	M	DG	DG	DG	EF	EF	EF	EG	EG	FM	FM	FM	FM	FM	LB	LB	LB	LB	LB	LB	LB	LB	LB	LB	LB	LB	GK	GK	GK	GK	GK	GK	GK	GK
91 pF	910	J	K	M	DG	DG	DG	EF	EF	EF	EG	EG	FM	FM	FM	FM	FM	LB	LB	LB	LB	LB	LB	LB	LB	LB	LB	LB	LB	GK	GK	GK	GK	GK	GK	GK	GK
100 pF	101	J	K	M	DG	DG	DG	EF	EF	EF	EG	EG	FM	FM	FM	FM	FM	LB	LB	LB	LB	LB	LB	LB	LB	LB	LB	LB	LB	GK	GK	GK	GK	GK	GK	GK	GK
110 pF	111	J	K	M	DG	DG	DG	EF	EF	EF	EG	EG	FM	FM	FM	FM	FM	LB	LB	LB	LB	LB	LB	LB	LB	LB	LB	LB	LB	GK	GK	GK	GK	GK	GK	GK	GK
120 pF	121	J	K	M	DG	DG	DG	EF	EF	EF	EG	EG	FM	FM	FM	FM	FM	LA	LA	LA	LA	LA	LA	LA	LA	LA	LA	LA	LA	GK	GK	GK	GK	GK	GK	GK	GK
130 pF	131	J	K	M	DG	DG	DG	EF	EF	EF	EG	EG	FG	FG	FG	FG	FM	LA	LA	LA	LA	LA	LA	LA	LA	LA	LA	LA	LA	GK	GK	GK	GK	GK	GK	GK	GK
150 pF	151	J	K	M	DG	DG	DG	EF	EF	EF	EG	EG	FG	FG	FG	FG	FM	LA	LA	LA	LA	LA	LA	LA	LA	LA	LA	LA	LA	GK	GK	GK	GK	GK	GK	GK	GK
180 pF	181	J	K	M	DG	DG	DG	EF	EF	EF	EG	EG	FG	FG	FG	FM	FM	LA	LA	LA	LA	LA	LA	LA	LA	LA	LA	LA	LA	GK	GK	GK	GK	GK	GK	GK	GK
220 pF	221	J	K	M	DG	DG	DG	EF	EG	EG	EG	EG	FG	FG	FG	FM	FM	LA	LA	LA	LA	LA	LA	LA	LA	LA	LA	LA	LA	GH	GH	GH	GH	GH	GH	GK	GK
270 pF	271	J	K	M	DG	DG	DG	EF	EG	EG	EG	EG	FG	FG	FG	FK	FK	LA	LA	LA	LA	LA	LA	LA	LA	LA	LA	LA	GH	GH	GH	GH	GH	GH	GK	GK	
330 pF	331	J	K	M	DG	DG	DG	EF	EG	EG	EG	EG	FG	FG	FG	FK	FK	LA	LA	LA	LA	LA	LA	LA	LA	LA	LA	LA	GH	GH	GH	GH	GH	GH	GK	GK	
390 pF	391	J	K	M	DG	DG	DG	EG	EG	EG	EG	EG	FG	FG	FG	FK	FS	LA	LA	LA	LA	LA	LA	LA	LA	LA	LA	LA	GK	GK	GK	GK	GK	GK	GK	GK	
470 pF	471	J	K	M	DG	DG	DG	EG	EG	EG	EF	EG	FG	FM	FM	FS	FS	LA	LB	LB	LB	LB	LB	LB	LB	LB	LB	LB	GK	GK	GK	GK	GK	GK	GK	GK	
560 pF	561	J	K	M	DG	DG	DG	EG	EG	EG	EF	EG	FG	FM	FM	FS	FL	LA	LB	LB	LB	LB	LB	LB	LB	LB	LB	LB	GH	GH	GH	GK	GH	GK	GH	GK	
680 pF	681	J	K	M	DG	DG	DG	EG	EG	EG	EF	EG	FG	FM	FM	FS	FL	LB	LB	LB	LB	LB	LB	LB	LB	LB	LB	LB	GH	GH	GH	GK	GH	GK	GH	GK	
820 pF	821	J	K	M	DG	DG	DG	EG	EF	EF	EF	EG	FG	FM	FM	FL	FL	LB	LB	LB	LA	LB	LB	LB	LB	LB	LB	LB	GH	GH	GH	GK	GH	GK	GH	GK	
1,000 pF	102	J	K	M	DG	DG	DG	EG	EF	EF	EF	EG	FM	FM	FM	FL	FL	LB	LB	LB	LA	LB	LB	LB	LB	LB	LB	LB	GH	GH	GH	GH	GH	GH	GK	GK	
1,200 pF	122	J	K	M	DG	DG	DG	EF	EF	EF	EG	EG	FM	FK	FK	FL	FL	LC	LC	LC	LB	LB	LB	LB	LB	LB	LB	LB	GH	GH	GK	GH	GH	GH	GK	GK	
1,500 pF	152	J	K	M	DG	DG	DG	EF	EF	EF	EG	EG	FK	FL	FL	FL	FL	LC	LC	LC	LB	LB	LB	LB	LB	LB	LB	LB	GH	GK	GK	GH	GH	GH	GH	GK	
1,800 pF	182	J	K	M	DG	DG	DG	EF	EF	EF	EG	EG	FK	FS	FS	FL	FL	LC	LC	LC	LB	LB	LB	LB	LB	LB	LB	LB	GH	GK	GK	GH	GH	GH	GH	GK	
2,000 pF	202	J	K	M	DG	DG	DG	EF	EF	EF	EG	EG	FK	FL	FL	FL	FL	LC	LA	LA	LA	LB	LB	LB	LB	LB	LB	LB	GH	GK	GK	GH	GH	GH	GH	GK	
2,200 pF	222	J	K	M	DG	DG	DG	EF	EF	EF	EG	EG	FK	FL	FL	FL	FL	LC	LA	LA	LA	LB	LB	LB	LB	LB	LB	LB	GH	GK	GK	GH	GH	GH	GH	GK	
2,700 pF	272	J	K	M	DG	DG	DG	EF	EF	EF	EG	EG	FS	FL	FL	FL	FL	LC	LA	LA	LA	LB	LB	LB	LB	LB	LB	LB	GH	GK	GK	GH	GH	GH	GH	GM	
3,300 pF	332	J	K	M	DG	DG	DG	EF	EF	EF	EG	EG	FS	FL	FL	FL	FL	LA	LA	LA	LA	LB	LA	LA	LA	LA	LA	LA	GH	GH	GH	GH	GH	GH	GH	GM	
3,900 pF	392	J	K	M	DG	DG	DG	EF	EF	EF	EG	EG	FL	FL	FL	FL	FK	LA	LA	LA	LA	LB	LB	LB	LB	LB	LB	LB	GH	GH	GH	GH	GH	GH	GH	GO	
4,700 pF	472	J	K	M	DG	DG	DG	EF	EF	EF	EG	EG	FL	FL	FL	FL	FK	LA	LA	LA	LA	LB	LB	LB	LB	LB	LB	LB	GH	GH	GH	GH	GH	GH	GH	GO	
5,600 pF	562	J	K	M	DG	DG	DG	EF	EF	EF	EG	EG	FL	FL	FL	FL	FK	LA	LB	LB	LB	LB	LB	LB	LB	LB	LB	LB	GH	GH	GH	GH	GH	GH	GH	GK	
6,800 pF	682	J	K	M	DG	DG																															

Table 2 – Chip Thickness/Packaging Quantities

Thickness Code	Case Size	Thickness ± Range (mm)	Paper Quantity		Plastic Quantity	
			7" Reel	13" Reel	7" Reel	13" Reel
DG	0805	1.25 ± 0.15	0	0	2,500	10,000
EF	1206	1.20 ± 0.15	0	0	2,500	10,000
EG	1206	1.60 ± 0.15	0	0	2,000	8,000
EJ	1206	1.70 ± 0.20	0	0	2,000	8,000
FG	1210	1.25 ± 0.15	0	0	2,500	10,000
FL	1210	1.40 ± 0.15	0	0	2,000	8,000
FH	1210	1.55 ± 0.15	0	0	2,000	8,000
FM	1210	1.70 ± 0.20	0	0	2,000	8,000
FK	1210	2.10 ± 0.20	0	0	2,000	8,000
FS	1210	2.50 ± 0.30	0	0	1,000	4,000
LE	1808	1.00 ± 0.10	0	0	2,500	10,000
LA	1808	1.40 ± 0.15	0	0	1,000	4,000
LB	1808	1.60 ± 0.15	0	0	1,000	4,000
LC	1808	2.00 ± 0.15	0	0	1,000	4,000
GB	1812	1.00 ± 0.10	0	0	1,000	4,000
GC	1812	1.10 ± 0.10	0	0	1,000	4,000
GE	1812	1.30 ± 0.10	0	0	1,000	4,000
GH	1812	1.40 ± 0.15	0	0	1,000	4,000
GF	1812	1.50 ± 0.10	0	0	1,000	4,000
GK	1812	1.60 ± 0.20	0	0	1,000	4,000
GJ	1812	1.70 ± 0.15	0	0	1,000	4,000
GN	1812	1.70 ± 0.20	0	0	1,000	4,000
GL	1812	1.90 ± 0.20	0	0	500	2,000
GM	1812	2.00 ± 0.20	0	0	500	2,000
GS	1812	2.10 ± 0.20	0	0	500	2,000
GO	1812	2.50 ± 0.20	0	0	500	2,000
HE	1825	1.40 ± 0.15	0	0	1,000	4,000
HG	1825	1.60 ± 0.20	0	0	1,000	4,000
HJ	1825	2.00 ± 0.20	0	0	500	2,000
HK	1825	2.50 ± 0.20	0	0	500	2,000
JE	2220	1.40 ± 0.15	0	0	1,000	4,000
JK	2220	1.60 ± 0.20	0	0	1,000	4,000
JL	2220	2.00 ± 0.20	0	0	500	2,000
JN	2220	2.50 ± 0.20	0	0	500	2,000
KE	2225	1.40 ± 0.15	0	0	1,000	4,000
KF	2225	1.60 ± 0.20	0	0	1,000	4,000
KH	2225	2.00 ± 0.20	0	0	500	2,000
KJ	2225	2.50 ± 0.20	0	0	500	2,000
Thickness Code	Case Size	Thickness ± Range (mm)	7" Reel	13" Reel	7" Reel	13" Reel
			Paper Quantity		Plastic Quantity	

Package quantity based on finished chip thickness specifications.

Table 3 – Chip Capacitor Land Pattern Design Recommendations per IPC–7351

EIA Size Code	Metric Size Code	Density Level A: Maximum (Most) Land Protrusion (mm)					Density Level B: Median (Nominal) Land Protrusion (mm)					Density Level C: Minimum (Least) Land Protrusion (mm)				
		C	Y	X	V1	V2	C	Y	X	V1	V2	C	Y	X	V1	V2
0805	2012	1.00	1.35	1.55	4.40	2.60	0.90	1.15	1.45	3.50	2.00	0.80	0.95	1.35	2.80	1.70
1206	3216	1.60	1.65	1.90	5.90	2.90	1.50	1.45	1.80	5.00	2.30	1.40	1.25	1.70	4.30	2.00
1210	3225	1.60	1.65	2.80	5.90	3.80	1.50	1.45	2.70	5.00	3.20	1.40	1.25	2.60	4.30	2.90
1210 ¹	3225	1.50	1.60	2.90	5.60	3.90	1.40	1.40	2.80	4.70	3.30	1.30	1.20	2.70	4.00	3.00
1808	4520	2.25	1.85	2.30	7.40	3.30	2.15	1.65	2.20	6.50	2.70	2.05	1.45	2.10	5.80	2.40
1812	4532	2.10	1.80	3.60	7.00	4.60	2.00	1.60	3.50	6.10	4.00	1.90	1.40	3.40	5.40	3.70
1825	4564	2.15	1.80	6.90	7.10	7.90	2.05	1.60	6.80	6.20	7.30	1.95	1.40	6.70	5.50	7.00
2220	5650	2.85	2.10	5.50	8.80	6.50	2.75	1.90	5.40	7.90	5.90	2.65	1.70	5.30	7.20	5.60
2225	5664	2.85	2.10	6.90	8.80	7.90	2.75	1.90	6.80	7.90	7.30	2.65	1.70	6.70	7.20	7.00

¹ Only for capacitance values $\geq 22 \mu\text{F}$

Density Level A: For low-density product applications. Recommended for wave solder applications and provides a wider process window for reflow solder processes. KEMET only recommends wave soldering of EIA 0603, 0805 and 1206 case sizes.

Density Level B: For products with a moderate level of component density. Provides a robust solder attachment condition for reflow solder processes.

Density Level C: For high component density product applications. Before adapting the minimum land pattern variations the user should perform qualification testing based on the conditions outlined in IPC Standard 7351 (IPC–7351).

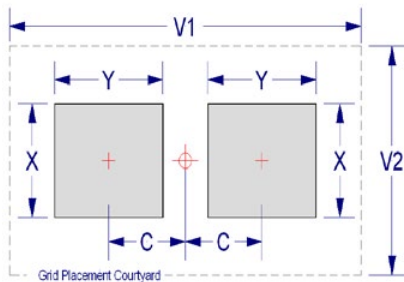

Soldering Process

Recommended Soldering Technique:

- Solder wave or solder reflow for EIA case sizes 0603, 0805 and 1206
- All other EIA case sizes are limited to solder reflow only

Recommended Soldering Profile:

- KEMET recommends following the guidelines outlined in IPC/JEDEC J–STD–020

Table 4 – Performance & Reliability: Test Methods and Conditions

Stress	Reference	Test or Inspection Method
Terminal Strength	JIS-C-6429	Appendix 1, Note: Force of 1.8 kg for 60 seconds.
Board Flex	JIS-C-6429	Appendix 2, Note: Standard termination system – 2.0 mm (minimum) for all except 3 mm for COG. Flexible termination system – 3.0 mm (minimum).
Solderability	J-STD-002	Magnification 50 X. Conditions:
		a) Method B, 4 hours @ 155°C, dry heat @ 235°C
		b) Method B @ 215°C category 3
		c) Method D, category 3 @ 260°C
Temperature Cycling	JESD22 Method JA-104	1,000 cycles (-55°C to +125°C). Measurement at 24 hours +/- 2 hours after test conclusion.
Biased Humidity	MIL-STD-202 Method 103	Load Humidity: 1,000 hours 85°C/85% RH and 200 VDC maximum. Add 100 K ohm resistor. Measurement at 24 hours +/- 2 hours after test conclusion.
		Low Volt Humidity: 1,000 hours 85°C/85% RH and 1.5 V. Add 100 K ohm resistor. Measurement at 24 hours +/- 2 hours after test conclusion.
Moisture Resistance	MIL-STD-202 Method 106	t = 24 hours/cycle. Steps 7a and 7b not required. Unpowered. Measurement at 24 hours +/- 2 hours after test conclusion.
Thermal Shock	MIL-STD-202 Method 107	-55°C/+125°C. Note: Number of cycles required – 300. Maximum transfer time – 20 seconds. Dwell time – 15 minutes. Air – Air.
High Temperature Life	MIL-STD-202 Method 108	1,000 hours at 125°C (85°C for X5R, Z5U and Y5V) with 1.2 X rated voltage applied.
Storage Life	MIL-STD-202 Method 108	150°C, 0 VDC for 1,000 hours.
Vibration	MIL-STD-202 Method 204	5 g's for 20 minutes, 12 cycles each of 3 orientations. Note: Use 8" X 5" PCB 0.031" thick, 7 secure points on one long side and 2 secure points at corners of opposite sides. Parts mounted within 2" from any secure point. Test from 10 – 2,000 Hz.
Mechanical Shock	MIL-STD-202 Method 213	Figure 1 of Method 213, Condition F.
Resistance to Solvents	MIL-STD-202 Method 215	Add aqueous wash chemical, OKEM Clean or equivalent.

Storage and Handling

Ceramic chip capacitors should be stored in normal working environments. While the chips themselves are quite robust in other environments, solderability will be degraded by exposure to high temperatures, high humidity, corrosive atmospheres, and long term storage. In addition, packaging materials will be degraded by high temperature– reels may soften or warp and tape peel force may increase. KEMET recommends that maximum storage temperature not exceed 40°C and maximum storage humidity not exceed 70% relative humidity. Temperature fluctuations should be minimized to avoid condensation on the parts and atmospheres should be free of chlorine and sulfur bearing compounds. For optimized solderability chip stock should be used promptly, preferably within 1.5 years of receipt.

Construction

Reference	Item		Material	
A	Termination System	Finish	100% Matte Sn	SnPb (5% min)
B		Barrier Layer	Ni	
D		Base Metal	Cu	
E	Inner Electrode		Ni	
F	Dielectric Material		BaTiO ₃	

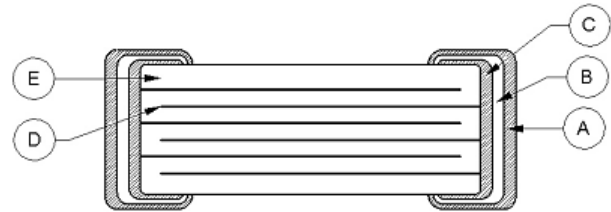

Note: Image is exaggerated in order to clearly identify all components of construction.

High Voltage with Flexible Termination System (HV FT-CAP) X7R Dielectric, 500 – 3,000 VDC (Commercial & Automotive Grade)

Overview

KEMET's High Voltage with Flexible Termination (HV FT-CAP) surface mount MLCCs in X7R dielectric address the primary failure mode of MLCCs— flex cracks, which are typically the result of excessive tensile and shear stresses produced during board flexure and thermal cycling. Featuring several of the highest CV (capacitance/voltage) values available in the industry, these devices utilize a pliable and conductive silver epoxy between the base metal and nickel barrier layers of the termination system. The addition of this epoxy layer inhibits the transfer of board stress to the rigid ceramic body, therefore mitigating flex cracks which can result in low IR or short circuit failures. Although flexible termination technology does not eliminate the potential for mechanical damage that may propagate during extreme environmental and handling conditions, it does provide superior flex performance over standard termination systems.

The HV FT-CAP offers low leakage current, exhibits low ESR at high frequencies and finds conventional use as snubbers or filters in applications such as switching power supplies and lighting ballasts. Their exceptional performance at high frequencies has made them a preferred choice of design engineers worldwide. In addition to their use in power supplies, these capacitors are widely used in industries related to

automotive(hybrid), telecommunications, medical, military, aerospace, semiconductors and test/diagnostic equipment.

Combined with the stability of an X7R dielectric and designed to accommodate all capacitance requirements, these flex-robust devices are RoHS Compliant, offer up to 5 mm of flex-bend capability and exhibits a predictable change in capacitance with respect to time and voltage. Capacitance change with reference to ambient temperature is limited to $\pm 15\%$ from -55°C to $+125^{\circ}\text{C}$.

Automotive Grade is available for applications requiring proven, reliable performance in harsh environments. Whether under-hood or in-cabin, these capacitors are designed for mission and safety critical automotive circuits. Stricter testing protocol and inspection criteria have been established for automotive grade products in recognition of potentially harsh environmental conditions. KEMET automotive grade series capacitors meet the demanding Automotive Electronics Council's AEC-Q200 qualification requirements.

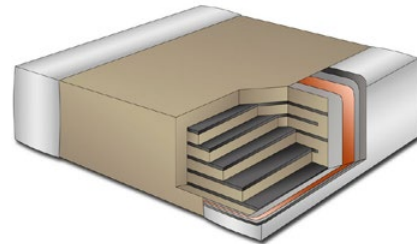

Ordering Information

C	1210	X	154	K	C	R	A	C	TU
Ceramic	Case Size (L" x W")	Specification/ Series	Capacitance Code (pF)	Capacitance Tolerance	Voltage	Dielectric	Failure Rate/ Design	Termination Finish ¹	Packaging/Grade (C-Spec) ²
	0805 1206 1210 1808 1812 1825 2220 2225	X = Flexible Termination	2 Significant Digits + Number of Zeros	J = $\pm 5\%$ K = $\pm 10\%$ M = $\pm 20\%$	C = 500 V B = 630 V D = 1,000 V F = 1,500 V G = 2,000 V Z = 2,500 V H = 3,000 V	R = X7R	A = N/A	C = 100% Matte Sn L = SnPb (5% min) C = 100% Matte Sn	Blank = Bulk TU = 7" Reel Unmarked TM = 7" Reel Marked AUTO = Automotive Grade 7" Reel Unmarked

¹ Additional termination finish options may be available. Contact KEMET for details.

^{1,2} SnPb termination finish option is not available on Automotive Grade product.

² Additional reeling or packaging options may be available. Contact KEMET for details.

Dimensions – Millimeters (Inches)

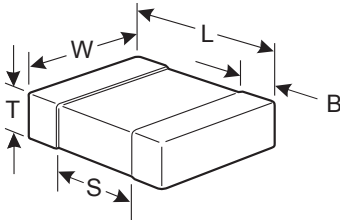

EIA Size Code	Metric Size Code	L Length	W Width	T Thickness	B Bandwidth	S Separation Minimum	Mounting Technique
0805	2012	2.00 (.079) ± 0.20 (.008)	1.25 (.049) ± 0.20 (.008)	See Table 2 for Thickness	0.50 (0.02) ± 0.25 (.010)	0.75 (.030)	Solder Wave or Solder Reflow
1206	3216	3.30 (.130) ± 0.40 (.016)	1.60 (.063) ± 0.20 (.008)		0.60 (.024) ± 0.25 (.010)	N/A	
1210	3225	3.30 (.130) ± 0.40 (.016)	2.50 (.098) ± 0.20 (.008)		0.60 (.024) ± 0.25 (.010)		
1808	4520	4.70 (.185) ± 0.50 (.020)	2.00 (.079) ± 0.20 (.008)		0.70 (.028) ± 0.35 (.014)		
1812	4532	4.50 (.178) ± 0.40 (.016)	3.20 (.126) ± 0.30 (.012)		0.70 (.028) ± 0.35 (.014)		
1825	4564	4.60 (.181) ± 0.40 (.016)	6.40 (.252) ± 0.40 (.016)		0.70 (.028) ± 0.35 (.014)		
2220	5650	5.90 (.232) ± 0.75 (.030)	5.00 (.197) ± 0.40 (.016)		0.70 (.028) ± 0.35 (.014)		
2225	5664	5.90 (.232) ± 0.75 (.030)	6.40 (.248) ± 0.40 (.016)		0.70 (.028) ± 0.35 (.014)	Solder Reflow Only	

Benefits

- -55°C to +125°C operating temperature range
- Industry-leading CV values
- Superior flex performance (up to 5 mm)
- Exceptional performance at high frequencies
- Pb-Free and RoHS Compliant
- EIA 0805, 1206, 1210, 1808, 1812, 1825, 2220, and 2225 case sizes
- DC voltage ratings of 500 V, 630 V, 1 KV, 1.5 KV, 2 KV, 2.5 KV, and 3 KV
- Capacitance offerings ranging from 130 pF to 0.33 µF
- Available capacitance tolerances of ±5%, ±10% or ±20%
- Low ESR and ESL
- Non-polar device, minimizing installation concerns
- Commercial and Automotive (AEC-Q200) Grades available
- 100% pure matte tin-plated termination finish allowing for excellent solderability
- SnPb plated termination finish option available upon request (5% minimum)

Applications

Typical applications include switch mode power supplies (input filters, resonators, tank circuits, snubber circuits, output filters), high voltage coupling and DC blocking, lighting ballasts, voltage multiplier circuits, DC/DC converters and coupling capacitors in Ćuk converters. Markets include power supply, LCD fluorescent backlight ballasts, HID lighting, telecom equipment, industrial and medical equipment/control, LAN/WAN interface, analog and digital modems, and automotive (electric and hybrid vehicles, charging stations and lighting) applications.

Application Note

X7R dielectric is not recommended for AC line filtering or pulse applications. These capacitors and/or the assembled circuit board containing these capacitors may require a protective surface coating to prevent external surface arcing.

Qualification/Certification

Commercial Grade products are subject to internal qualification. Details regarding test methods and conditions are referenced in Table 4, Performance & Reliability.

Automotive Grade products meet or exceed the requirements outlined by the Automotive Electronics Council. Details regarding test methods and conditions are referenced in document AEC-Q200, Stress Test Qualification for Passive Components. For additional information regarding the Automotive Electronics Council and AEC-Q200, please visit their website at www.aecouncil.com.

Environmental Compliance

Pb-Free and RoHS Compliant (excluding SnPb termination finish option).



RoHS Compliant

Electrical Parameters/Characteristics

Item	Parameters/Characteristics
Operating Temperature Range	-55°C to +125°C
Capacitance Change with Reference to +25°C and 0 VDC Applied (TCC)	±15%
Aging Rate (Maximum % Capacitance Loss/Decade Hour)	3.0%
Dielectric Withstanding Voltage	150% of rated voltage for voltage rating of < 1,000 V 120% of rated voltage for voltage rating of ≥ 1,000 V (5 ±1 seconds and charge/discharge not exceeding 50 mA)
Dissipation Factor (DF) Maximum Limit @ 25°C	2.5%
Insulation Resistance (IR) Limit @ 25°C	See Insulation Resistance Limit Table (500 VDC applied for 120 ±5 seconds @ 25°C)

Regarding aging rate: Capacitance measurements (including tolerance) are indexed to a referee time of 1,000 hours.

To obtain IR limit, divide MΩ-μF value by the capacitance and compare to GΩ limit. Select the lower of the two limits.

Capacitance and dissipation factor (DF) measured under the following conditions:

1 kHz ± 50 Hz and 1.0 ±0.2 Vrms if capacitance ≤ 10 μF

120 Hz ± 10 Hz and 0.5 ±0.1 Vrms if capacitance > 10 μF

Note: When measuring capacitance it is important to ensure the set voltage level is held constant. The HP4284 and Agilent E4980 have a feature known as Automatic Level Control (ALC). The ALC feature should be switched to "ON."

Post Environmental Limits

High Temperature Life, Biased Humidity, Moisture Resistance					
Dielectric	Rated DC Voltage	Capacitance Value	Dissipation Factor (%)	Capacitance Shift	Insulation Resistance
X7R	> 25	All	3.0	±20%	10% of Initial Limit
	16/25		5.0		
	< 16		7.5		

Insulation Resistance Limit Table (X7R Dielectric)

EIA Case Size	1,000 Megohm Microfarads or 100 GΩ	100 Megohm Microfarads or 10 GΩ
0805	< 0.0039 μF	≥ 0.0039 μF
1206	< 0.012 μF	≥ 0.012 μF
1210	< 0.033 μF	≥ 0.033 μF
1808	< 0.018 μF	≥ 0.018 μF
1812	< 0.027 μF	≥ 0.027 μF
≥ 1825	All	All

Table 2 – Chip Thickness/Packaging Quantities

Thickness Code	Case Size	Thickness ± Range (mm)	Paper Quantity		Plastic Quantity	
			7" Reel	13" Reel	7" Reel	13" Reel
DG	0805	1.25 ± 0.15	0	0	2,500	10,000
EF	1206	1.20 ± 0.15	0	0	2,500	10,000
EG	1206	1.60 ± 0.15	0	0	2,000	8,000
EJ	1206	1.70 ± 0.20	0	0	2,000	8,000
FG	1210	1.25 ± 0.15	0	0	2,500	10,000
FL	1210	1.40 ± 0.15	0	0	2,000	8,000
FH	1210	1.55 ± 0.15	0	0	2,000	8,000
FM	1210	1.70 ± 0.20	0	0	2,000	8,000
FK	1210	2.10 ± 0.20	0	0	2,000	8,000
FS	1210	2.50 ± 0.30	0	0	1,000	4,000
LE	1808	1.00 ± 0.10	0	0	2,500	10,000
LA	1808	1.40 ± 0.15	0	0	1,000	4,000
LB	1808	1.60 ± 0.15	0	0	1,000	4,000
LC	1808	2.00 ± 0.15	0	0	1,000	4,000
GB	1812	1.00 ± 0.10	0	0	1,000	4,000
GC	1812	1.10 ± 0.10	0	0	1,000	4,000
GE	1812	1.30 ± 0.10	0	0	1,000	4,000
GG	1812	1.55 ± 0.10	0	0	1,000	4,000
GH	1812	1.40 ± 0.15	0	0	1,000	4,000
GF	1812	1.50 ± 0.10	0	0	1,000	4,000
GK	1812	1.60 ± 0.20	0	0	1,000	4,000
GJ	1812	1.70 ± 0.15	0	0	1,000	4,000
GN	1812	1.70 ± 0.20	0	0	1,000	4,000
GL	1812	1.90 ± 0.20	0	0	500	2,000
GM	1812	2.00 ± 0.20	0	0	500	2,000
GS	1812	2.10 ± 0.20	0	0	500	2,000
GO	1812	2.50 ± 0.20	0	0	500	2,000
HE	1825	1.40 ± 0.15	0	0	1,000	4,000
HG	1825	1.60 ± 0.20	0	0	1,000	4,000
HJ	1825	2.00 ± 0.20	0	0	500	2,000
HK	1825	2.50 ± 0.20	0	0	500	2,000
JE	2220	1.40 ± 0.15	0	0	1,000	4,000
JK	2220	1.60 ± 0.20	0	0	500	2,000
JL	2220	2.00 ± 0.20	0	0	500	2,000
JN	2220	2.50 ± 0.20	0	0	500	2,000
KE	2225	1.40 ± 0.15	0	0	1,000	4,000
KF	2225	1.60 ± 0.20	0	0	1,000	4,000
KH	2225	2.00 ± 0.20	0	0	500	2,000
KJ	2225	2.50 ± 0.20	0	0	500	2,000
Thickness Code	Case Size	Thickness ± Range (mm)	7" Reel	13" Reel	7" Reel	13" Reel
			Paper Quantity		Plastic Quantity	

Package quantity based on finished chip thickness specifications.

Table 3 – Chip Capacitor Land Pattern Design Recommendations per IPC–7351

EIA Size Code	Metric Size Code	Density Level A: Maximum (Most) Land Protrusion (mm)					Density Level B: Median (Nominal) Land Protrusion (mm)					Density Level C: Minimum (Least) Land Protrusion (mm)				
		C	Y	X	V1	V2	C	Y	X	V1	V2	C	Y	X	V1	V2
0805	2012	1.00	1.35	1.55	4.40	2.60	0.90	1.15	1.45	3.50	2.00	0.80	0.95	1.35	2.80	1.70
1206	3216	1.60	1.65	1.90	5.90	2.90	1.50	1.45	1.80	5.00	2.30	1.40	1.25	1.70	4.30	2.00
1210	3225	1.60	1.65	2.80	5.90	3.80	1.50	1.45	2.70	5.00	3.20	1.40	1.25	2.60	4.30	2.90
1808	4520	2.25	1.85	2.30	7.40	3.30	2.15	1.65	2.20	6.50	2.70	2.05	1.45	2.10	5.80	2.40
1812	4532	2.10	1.80	3.60	7.00	4.60	2.00	1.60	3.50	6.10	4.00	1.90	1.40	3.40	5.40	3.70
1825	4564	2.15	1.80	6.90	7.10	7.90	2.05	1.60	6.80	6.20	7.30	1.95	1.40	6.70	5.50	7.00
2220	5650	2.85	2.10	5.50	8.80	6.50	2.75	1.90	5.40	7.90	5.90	2.65	1.70	5.30	7.20	5.60
2225	5664	2.85	2.10	6.90	8.80	7.90	2.75	1.90	6.80	7.90	7.30	2.65	1.70	6.70	7.20	7.00

Density Level A: For low-density product applications. Recommended for wave solder applications and provides a wider process window for reflow solder processes. KEMET only recommends wave soldering of EIA 0603, 0805 and 1206 case sizes.

Density Level B: For products with a moderate level of component density. Provides a robust solder attachment condition for reflow solder processes.

Density Level C: For high component density product applications. Before adapting the minimum land pattern variations the user should perform qualification testing based on the conditions outlined in IPC Standard 7351 (IPC–7351).

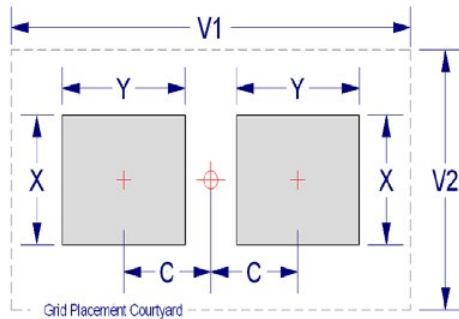

Soldering Process

Recommended Soldering Technique:

- Solder wave or solder reflow for EIA case sizes 0603, 0805 and 1206
- All other EIA case sizes are limited to solder reflow only

Recommended Soldering Profile:

- KEMET recommends following the guidelines outlined in IPC/JEDEC J–STD–020

Table 4 – Performance & Reliability: Test Methods and Conditions

Stress	Reference	Test or Inspection Method
Terminal Strength	JIS-C-6429	Appendix 1, Note: Force of 1.8 kg for 60 seconds.
Board Flex	JIS-C-6429	Appendix 2, Note: Standard termination system – 2.0 mm (minimum) for all except 3 mm for COG. Flexible termination system – 3.0 mm (minimum).
Solderability	J-STD-002	Magnification 50 X. Conditions:
		a) Method B, 4 hours @ 155°C, dry heat @ 235°C
		b) Method B @ 215°C category 3
		c) Method D, category 3 @ 260°C
Temperature Cycling	JESD22 Method JA-104	1,000 cycles (-55°C to +125°C). Measurement at 24 hours +/- 2 hours after test conclusion.
Biased Humidity	MIL-STD-202 Method 103	Load Humidity: 1,000 hours 85°C/85% RH and 200 VDC maximum. Add 100 K ohm resistor. Measurement at 24 hours +/- 2 hours after test conclusion.
		Low Volt Humidity: 1,000 hours 85°C/85% RH and 1.5 V. Add 100 K ohm resistor. Measurement at 24 hours +/- 2 hours after test conclusion.
Moisture Resistance	MIL-STD-202 Method 106	t = 24 hours/cycle. Steps 7a and 7b not required. Unpowered. Measurement at 24 hours +/- 2 hours after test conclusion.
Thermal Shock	MIL-STD-202 Method 107	-55°C/+125°C. Note: Number of cycles required – 300. Maximum transfer time – 20 seconds. Dwell time – 15 minutes. Air – Air.
High Temperature Life	MIL-STD-202 Method 108	1,000 hours at 125°C (85°C for X5R, Z5U and Y5V) with 1.2 X rated voltage applied.
Storage Life	MIL-STD-202 Method 108	150°C, 0 VDC for 1,000 hours.
Vibration	MIL-STD-202 Method 204	5 g's for 20 min., 12 cycles each of 3 orientations. Note: Use 8" X 5" PCB 0.031" thick 7 secure points on one long side and 2 secure points at corners of opposite sides. Parts mounted within 2" from any secure point. Test from 10 – 2,000 Hz
Mechanical Shock	MIL-STD-202 Method 213	Figure 1 of Method 213, Condition F.
Resistance to Solvents	MIL-STD-202 Method 215	Add aqueous wash chemical, OKEM Clean or equivalent.

Storage and Handling

Ceramic chip capacitors should be stored in normal working environments. While the chips themselves are quite robust in other environments, solderability will be degraded by exposure to high temperatures, high humidity, corrosive atmospheres, and long term storage. In addition, packaging materials will be degraded by high temperature– reels may soften or warp and tape peel force may increase. KEMET recommends that maximum storage temperature not exceed 40°C and maximum storage humidity not exceed 70% relative humidity. Temperature fluctuations should be minimized to avoid condensation on the parts and atmospheres should be free of chlorine and sulfur bearing compounds. For optimized solderability chip stock should be used promptly, preferably within 1.5 years of receipt.

Construction

Reference	Item	Material
A	Termination System	Finish
B		Barrier Layer
C		Epoxy Layer
D		Base Metal
E	Inner Electrode	Ni
F	Dielectric Material	BaTiO ₃

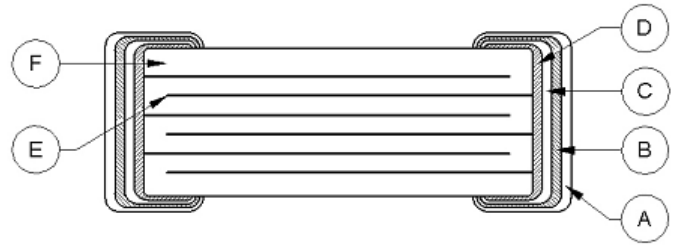

Note: Image is exaggerated in order to clearly identify all components of construction.

ArcShield™ Technology, High Voltage, X7R Dielectric, 500 – 1,000 VDC (Commercial & Automotive Grade)

Overview

KEMET "ArcShield" high voltage surface mount capacitors in X7R Dielectric are designed for use in high voltage applications susceptible to surface arcing (arc-over discharge).

The phenomenon of surface arcing is caused by a high voltage gradient between the two termination surfaces or between one of the termination surfaces and the counter internal electrode structure within the ceramic body. It occurs most frequently at application voltages that meet or exceed 300 V, in high humidity environments, and in chip sizes with minimal bandwidth separation (creepage distance). This phenomenon can either damage surrounding components or lead to a breakdown of the dielectric material, ultimately resulting in a short-circuit condition (catastrophic failure mode).

"ArcShield" Technology (Patent Pending) features KEMET's highly reliable base metal dielectric system combined with a unique internal shield electrode structure that is designed to suppress an arc-over event while increasing available capacitance. Developed on the principle of a partial Faraday cage, this internal system offers unrivaled performance and reliability when compared to external surface coating technologies.

For added reliability, KEMET's Flexible Termination technology is an available option that provides superior flex performance over standard termination systems. This technology was developed to address flex cracks, which are the primary failure mode of MLCCs and typically the result of excessive tensile and shear stresses produced during board flexure and thermal cycling. Flexible Termination technology inhibits the transfer of board stress to the rigid body of the MLCC, therefore mitigating flex cracks which can result in low IR or short circuit failures.

KEMET's "ArcShield" high voltage surface mount MLCCs are available in automotive grade, which undergo stricter testing protocol and inspection criteria. Whether under-hood or in-cabin, these devices are designed for mission and safety-critical automotive circuits or applications requiring proven, reliable performance in harsh environments. Automotive grade devices meet the demanding Automotive Electronics Council's AEC-Q200 qualification requirements.

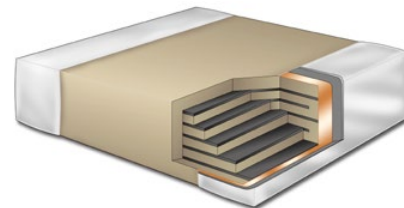

Ordering Information

C	1812	V	334	K	C	R	A	C	TU
Ceramic	Case Size (L" x W")	Specification/ Series	Capacitance Code (pF)	Capacitance Tolerance	Voltage	Dielectric	Failure Rate/ Design	Termination Finish ¹	Packaging/Grade (C-Spec) ²
	0805 1206 1210 1808 1812	V = ArcShield W = ArcShield with Flexible Termination	2 Significant Digits + Number of Zeros	J = ±5% K = ±10% M = ±20%	C = 500 V B = 630 V D = 1,000 V	R = X7R	A = N/A	C = 100% Matte Sn L = SnPb (5% minimum)	Blank = Bulk TU = 7" Reel Unmarked TM = 7" Reel Marked AUTO = Automotive Grade 7" Reel Unmarked

¹ Additional termination finish options may be available. Contact KEMET for details.

^{1,2} SnPb termination finish option is not available on Automotive Grade product.

² Additional reeling or packaging options may be available. Contact KEMET for details.

Dimensions – Millimeters (Inches) – Standard Termination

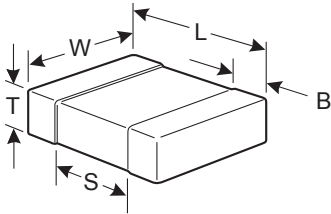

EIA Size Code	Metric Size Code	L Length	W Width	T Thickness	B Bandwidth	S Separation Minimum	Mounting Technique
0805	2012	2.00 (.079) ± 0.20 (.008)	1.25 (.049) ± 0.20 (.008)	See Table 2 for Thickness	0.50 (0.02) ± 0.25 (.010)	0.75 (.030)	Solder Wave or Solder Reflow
1206	3216	3.20 (.126) ± 0.20 (.008)	1.60 (.063) ± 0.20 (.008)		0.50 (0.02) ± 0.25 (.010)	N/A	
1210	3225	3.20 (.126) ± 0.20 (.008)	2.50 (.098) ± 0.20 (.008)		0.50 (0.02) ± 0.25 (.010)		Solder Reflow Only
1808	4520	4.70 (.185) ± 0.50 (.020)	2.00 (.079) ± 0.20 (.008)		0.60 (.024) ± 0.35 (.014)		
1812	4532	4.50 (.177) ± 0.30 (.012)	3.20 (.126) ± 0.30 (.012)		0.60 (.024) ± 0.35 (.014)		

Dimensions – Millimeters (Inches) – Flexible Termination

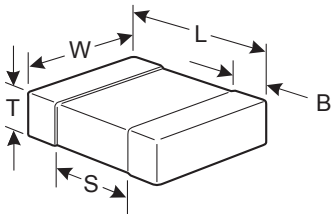

EIA Size Code	Metric Size Code	L Length	W Width	T Thickness	B Bandwidth	S Separation Minimum	Mounting Technique
0805	2012	2.00 (.079) ± 0.20 (.008)	1.25 (.049) ± 0.20 (.008)	See Table 2 for Thickness	0.50 (0.02) ± 0.25 (.010)	0.75 (.030)	Solder Wave or Solder Reflow
1206	3216	3.30 (.130) ± 0.40 (.016)	1.60 (.063) ± 0.20 (.008)		0.60 (.024) ± 0.25 (.010)	N/A	
1210	3225	3.30 (.130) ± 0.40 (.016)	2.50 (.098) ± 0.20 (.008)		0.60 (.024) ± 0.25 (.010)		Solder Reflow Only
1808	4520	4.70 (.185) ± 0.50 (.020)	2.00 (.079) ± 0.20 (.008)		0.70 (.028) ± 0.35 (.014)		
1812	4532	4.50 (.178) ± 0.40 (.016)	3.20 (.126) ± 0.30 (.012)		0.70 (.028) ± 0.35 (.014)		

Benefits

- ArcShield (patent pending) technology
- Base metal electrode (BME) dielectric system
- Industry leading CV values
- -55°C to +125°C operating temperature range
- Exceptional performance at high frequencies
- Pb-Free and RoHS Compliant
- EIA 0805, 1206, 1210, 1808, and 1812 case sizes
- DC voltage ratings of 500 V, 630 V, and 1 KV
- Capacitance offerings ranging from 2,200 pF to 0.33 μ F
- Available capacitance tolerances of $\pm 5\%$, $\pm 10\%$, and $\pm 20\%$
- Low ESR and ESL
- Non-polar device, minimizing installation concerns
- 100% pure matte tin-plated termination finish allowing for excellent solderability
- SnPb plated termination finish option available upon request (5% minimum)
- Flexible Termination option available upon request

Applications

Typical applications include switch mode power supplies (input filters, resonators, tank circuits, snubber circuits, output filters), high voltage coupling and DC blocking, lighting ballasts, voltage multiplier circuits, DC/DC converters and coupling capacitors in \hat{C} uk converters. Markets include power supply, LCD fluorescent backlight ballasts, HID lighting, telecom equipment, industrial and medical equipment/control, LAN/WAN interface, analog and digital modems, and automotive (electric and hybrid vehicles, charging stations and lighting) applications.

Application Notes

X7R dielectric is not recommended for AC line filtering or pulse applications.

Qualification/Certification

Commercial Grade products are subject to internal qualification. Details regarding test methods and conditions are referenced in Table 4, Performance & Reliability.

Automotive Grade products meet or exceed the requirements outlined by the Automotive Electronics Council. Details regarding test methods and conditions are referenced in document AEC-Q200, Stress Test Qualification for Passive Components. For additional information regarding the Automotive Electronics Council and AEC-Q200, please visit their website at www.aecouncil.com.

Environmental Compliance

Pb-Free and RoHS Compliant (excluding SnPb termination finish option).



RoHS Compliant

Electrical Parameters/Characteristics

Item	Parameters/Characteristics
Operating Temperature Range	-55°C to +125°C
Capacitance Change with Reference to +25°C and 0 VDC Applied (TCC)	±15%
Aging Rate (Maximum % Capacitance Loss/Decade Hour)	3.0%
Dielectric Withstanding Voltage (DWV)	150% of rated voltage for voltage rating of < 1,000 V 120% of rated voltage for voltage rating of ≥ 1,000 V (5 ±1 seconds and charge/discharge not exceeding 50 mA)
Dissipation Factor (DF) Maximum Limit @ 25°C	2.5%
Insulation Resistance (IR) Limit @ 25°C	100 megohm microfarads or 10 GΩ (500 VDC applied for 120 ±5 seconds @ 25°C)

Regarding aging rate: Capacitance measurements (including tolerance) are indexed to a referee time of 1,000 hours.

To obtain IR limit, divide $M\Omega\text{-}\mu\text{F}$ value by the capacitance and compare to GΩ limit. Select the lower of the two limits.

Capacitance and dissipation factor (DF) measured under the following conditions:

1 kHz ±50 Hz and 1.0 ±0.2 Vrms if capacitance ≤ 10 μF

120 Hz ±10 Hz and 0.5 ±0.1 Vrms if capacitance > 10 μF

Note: When measuring capacitance, it is important to ensure the set voltage level is held constant. The HP4284 and Agilent E4980 have a feature known as Automatic Level Control (ALC). The ALC feature should be switched to "ON."

Post Environmental Limits

High Temperature Life, Biased Humidity, Moisture Resistance					
Dielectric	Rated DC Voltage	Capacitance Value	Dissipation Factor (Maximum %)	Capacitance Shift	Insulation Resistance
X7R	> 25	All	3.0	±20%	10% of Initial Limit
	16/25		5.0		
	< 16		7.5		

Table 1 – Capacitance Range/Selection Waterfall (0805 – 1812 Case Sizes)

Capacitance	Capacitance Code	Case Size / Series			C0805W/V			C1206W/V			C1210W/V			C1808W/V			C1812W/V		
		Voltage Code			C	B	D	C	B	D	C	B	D	C	B	D	C	B	D
		Rated Voltage (VDC)			500	630	1000	500	630	1000	500	630	1000	500	630	1000	500	630	1000
		Capacitance Tolerance			Product Availability and Chip Thickness Codes See Table 2 for Chip Thickness Dimensions														
2,200 pF	222	J	K	M	DG	DG	DG												
2,700 pF	272	J	K	M	DG	DG	DG												
3,300 pF	332	J	K	M	DG	DG	DG												
3,900 pF	392	J	K	M	DG	DG	DG												
4,700 pF	472	J	K	M	DG	DG	DG												
5,600 pF	562	J	K	M	DG	DG													
6,800 pF	682	J	K	M	DG	DG													
8,200 pF	822	J	K	M	DG	DG													
10,000 pF	103	J	K	M	DG														
12,000 pF	123	J	K	M	DG			EJ	EJ	EJ									
15,000 pF	153	J	K	M				EJ	EJ	EJ									
18,000 pF	183	J	K	M				EJ	EJ	EJ				LE	LE	LE			
22,000 pF	223	J	K	M				EJ	EJ	EJ	FG	FG	FG	LE	LE	LE			
27,000 pF	273	J	K	M				EJ	EJ		FG	FG	FG	LA	LA	LA	GB	GB	GB
33,000 pF	333	J	K	M				EJ	EJ		FG	FG	FH	LA	LA	LA	GB	GB	GB
39,000 pF	393	J	K	M				EJ			FG	FG	FH	LA	LA	LA	GB	GB	GB
47,000 pF	473	J	K	M				EJ			FG	FH	FK	LA	LA	LB	GB	GB	GC
56,000 pF	563	J	K	M				EJ			FG	FH	FK	LA	LA	LB	GB	GB	GE
62,000 pF	623	J	K	M				EJ			FG	FK	FS	LA	LA	LC	GB	GB	GE
68,000 pF	683	J	K	M				EJ			FG	FK	FS	LA	LA	LC	GE	GE	GE
82,000 pF	823	J	K	M							FH	FK		LA	LC		GB	GE	GK
0.10 µF	104	J	K	M							FK	FS		LA	LC		GB	GH	GJ
0.12 µF	124	J	K	M							FK			LA			GE	GK	
0.15 µF	154	J	K	M							FK			LB			GE	GN	
0.18 µF	184	J	K	M													GF		
0.22 µF	224	J	K	M													GJ		
0.27 µF	274	J	K	M													GL		
0.33 µF	334	J	K	M													GS		
Capacitance	Capacitance Code	Rated Voltage (VDC)			500	630	1000	500	630	1000	500	630	1000	500	630	1000	500	630	1000
		Voltage Code			C	B	D	C	B	D	C	B	D	C	B	D	C	B	D
		Case Size / Series			C0805W/V			C1206W/V			C1210W/V			C1808W/V			C1812W/V		

Patent pending technology

KEMET reserves the right to substitute product with an improved temperature characteristic, tighter capacitance tolerance and/or higher voltage capability within the same form factor (configuration and dimensions).

Table 2 – Chip Thickness/Packaging Quantities

Thickness Code	Case Size	Thickness ± Range (mm)	Paper Quantity		Plastic Quantity	
			7" Reel	13" Reel	7" Reel	13" Reel
DG	0805	1.25 ± 0.15	0	0	2,500	10,000
EJ	1206	1.70 ± 0.20	0	0	2,000	8,000
FG	1210	1.25 ± 0.15	0	0	2,500	10,000
FH	1210	1.55 ± 0.15	0	0	2,000	8,000
FK	1210	2.10 ± 0.20	0	0	2,000	8,000
FS	1210	2.50 ± 0.30	0	0	1,000	4,000
LE	1808	1.00 ± 0.10	0	0	2,500	10,000
LA	1808	1.40 ± 0.15	0	0	1,000	4,000
LB	1808	1.60 ± 0.15	0	0	1,000	4,000
LC	1808	2.00 ± 0.15	0	0	1,000	4,000
GB	1812	1.00 ± 0.10	0	0	1,000	4,000
GC	1812	1.10 ± 0.10	0	0	1,000	4,000
GE	1812	1.30 ± 0.10	0	0	1,000	4,000
GH	1812	1.40 ± 0.15	0	0	1,000	4,000
GF	1812	1.50 ± 0.10	0	0	1,000	4,000
GK	1812	1.60 ± 0.20	0	0	1,000	4,000
GJ	1812	1.70 ± 0.15	0	0	1,000	4,000
GN	1812	1.70 ± 0.20	0	0	1,000	4,000
GL	1812	1.90 ± 0.20	0	0	500	2,000
GS	1812	2.10 ± 0.20	0	0	500	2,000
Thickness Code	Case Size	Thickness ± Range (mm)	7" Reel	13" Reel	7" Reel	13" Reel
			Paper Quantity		Plastic Quantity	

Package quantity based on finished chip thickness specifications.

Table 3A – Land Pattern Design Recommendations per IPC-7351 – Standard Termination

EIA Size Code	Metric Size Code	Density Level A: Maximum (Most) Land Protrusion (mm)					Density Level B: Median (Nominal) Land Protrusion (mm)					Density Level C: Minimum (Least) Land Protrusion (mm)				
		C	Y	X	V1	V2	C	Y	X	V1	V2	C	Y	X	V1	V2
0805	2012	1.00	1.35	1.55	4.40	2.60	0.90	1.15	1.45	3.50	2.00	0.75	0.95	1.35	2.80	1.70
1206	3216	1.60	1.35	1.90	5.60	2.90	1.50	1.15	1.80	4.70	2.30	1.40	0.95	1.70	4.00	2.00
1210	3225	1.60	1.35	2.80	5.65	3.80	1.50	1.15	2.70	4.70	3.20	1.40	0.95	2.60	4.00	2.90
1210 ¹	3225	1.50	1.60	2.90	5.60	3.90	1.40	1.40	2.80	4.70	3.30	1.30	1.20	2.70	4.00	3.00
1808	4520	2.30	1.75	2.30	7.40	3.30	2.20	1.55	2.20	6.50	2.70	2.10	1.35	2.10	5.80	2.40
1812	4532	2.15	1.60	3.60	6.90	4.60	2.05	1.40	3.50	6.00	4.00	1.95	1.20	3.40	5.30	3.70

¹ Only for capacitance values ≥ 22 μF

Density Level A: For low-density product applications. Recommended for wave solder applications and provides a wider process window for reflow solder processes. KEMET only recommends wave soldering of EIA 0603, 0805 and 1206 case sizes.

Density Level B: For products with a moderate level of component density. Provides a robust solder attachment condition for reflow solder processes.

Density Level C: For high component density product applications. Before adapting the minimum land pattern variations the user should perform qualification testing based on the conditions outlined in IPC Standard 7351 (IPC-7351).

Table 3B – Land Pattern Design Recommendations per IPC–7351 – Flexible Termination

EIA Size Code	Metric Size Code	Density Level A: Maximum (Most) Land Protrusion (mm)					Density Level B: Median (Nominal) Land Protrusion (mm)					Density Level C: Minimum (Least) Land Protrusion (mm)				
		C	Y	X	V1	V2	C	Y	X	V1	V2	C	Y	X	V1	V2
0805	2012	1.00	1.35	1.55	4.40	2.60	0.90	1.15	1.45	3.50	2.00	0.80	0.95	1.35	2.80	1.70
1206	3216	1.60	1.65	1.90	5.90	2.90	1.50	1.45	1.80	5.00	2.30	1.40	1.25	1.70	4.30	2.00
1210	3225	1.60	1.65	2.80	5.90	3.80	1.50	1.45	2.70	5.00	3.20	1.40	1.25	2.60	4.30	2.90
1808	4520	2.25	1.85	2.30	7.40	3.30	2.15	1.65	2.20	6.50	2.70	2.05	1.45	2.10	5.80	2.40
1812	4532	2.10	1.80	3.60	7.00	4.60	2.00	1.60	3.50	6.10	4.00	1.90	1.40	3.40	5.40	3.70

Density Level A: For low-density product applications. Recommended for wave solder applications and provides a wider process window for reflow solder processes. KEMET only recommends wave soldering of EIA 0603, 0805 and 1206 case sizes.

Density Level B: For products with a moderate level of component density. Provides a robust solder attachment condition for reflow solder processes.

Density Level C: For high component density product applications. Before adapting the minimum land pattern variations the user should perform qualification testing based on the conditions outlined in IPC Standard 7351 (IPC–7351).

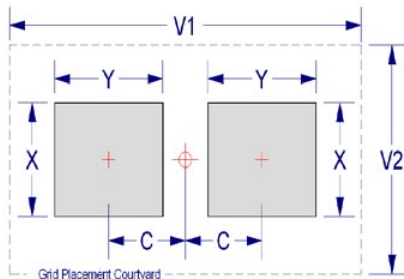

Soldering Process

Recommended Soldering Technique:

- Solder wave or solder reflow for EIA case sizes 0603, 0805 and 1206
- All other EIA case sizes are limited to solder reflow only

Recommended Soldering Profile:

- KEMET recommends following the guidelines outlined in IPC/JEDEC J–STD–020

Table 4 – Performance & Reliability: Test Methods and Conditions

Stress	Reference	Test or Inspection Method
Terminal Strength	JIS-C-6429	Appendix 1, Note: Force of 1.8 kg for 60 seconds.
Board Flex	JIS-C-6429	Appendix 2, Note: Standard termination system – 2.0 mm (minimum) for all except 3 mm for COG. Flexible termination system – 3.0 mm (minimum).
Solderability	J-STD-002	Magnification 50 X. Conditions:
		a) Method B, 4 hours @ 155°C, dry heat @ 235°C
		b) Method B @ 215°C category 3
		c) Method D, category 3 @ 260°C
Temperature Cycling	JESD22 Method JA-104	1,000 cycles (-55°C to +125°C). Measurement at 24 hours +/- 2 hours after test conclusion.
Biased Humidity	MIL-STD-202 Method 103	Load Humidity: 1,000 hours 85°C/85% RH and 200 VDC maximum. Add 100 K ohm resistor. Measurement at 24 hours +/- 2 hours after test conclusion.
		Low Volt Humidity: 1,000 hours 85°C/85% RH and 1.5 V. Add 100 K ohm resistor. Measurement at 24 hours +/- 2 hours after test conclusion.
Moisture Resistance	MIL-STD-202 Method 106	t = 24 hours/cycle. Steps 7a and 7b not required. Unpowered. Measurement at 24 hours +/- 2 hours after test conclusion.
Thermal Shock	MIL-STD-202 Method 107	-55°C/+125°C. Note: Number of cycles required – 300. Maximum transfer time – 20 seconds. Dwell time – 15 minutes. Air – Air.
High Temperature Life	MIL-STD-202 Method 108	1,000 hours at 125°C (85°C for X5R, Z5U and Y5V) with 1.2 X rated voltage applied.
Storage Life	MIL-STD-202 Method 108	150°C, 0 VDC for 1,000 hours.
Vibration	MIL-STD-202 Method 204	5 g's for 20 min., 12 cycles each of 3 orientations. Note: Use 8" X 5" PCB 0.031" thick 7 secure points on one long side and 2 secure points at corners of opposite sides. Parts mounted within 2" from any secure point. Test from 10 – 2,000 Hz
Mechanical Shock	MIL-STD-202 Method 213	Figure 1 of Method 213, Condition F.
Resistance to Solvents	MIL-STD-202 Method 215	Add aqueous wash chemical, OKEM Clean or equivalent.

Storage & Handling

Ceramic chip capacitors should be stored in normal working environments. While the chips themselves are quite robust in other environments, solderability will be degraded by exposure to high temperatures, high humidity, corrosive atmospheres, and long term storage. In addition, packaging materials will be degraded by high temperature– reels may soften or warp and tape peel force may increase. KEMET recommends that maximum storage temperature not exceed 40°C and maximum storage humidity not exceed 70% relative humidity. Temperature fluctuations should be minimized to avoid condensation on the parts and atmospheres should be free of chlorine and sulfur bearing compounds. For optimized solderability chip stock should be used promptly, preferably within 1.5 years of receipt.

Construction – Standard Termination

Reference	Item		Material	
A	Termination System	Finish	100% Matte Sn	SnPb (5% min)
B		Barrier Layer	Ni	
D		Base Metal	Cu	
E	Inner Electrode		Ni	
F	Dielectric Material		BaTiO ₃	

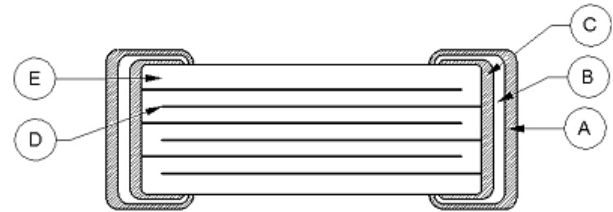

Note: Image is exaggerated in order to clearly identify all components of construction.

Construction – Flexible Termination

Reference	Item		Material	
A	Termination System	Finish	100% Matte Sn	SnPb (5% min)
B		Barrier Layer	Ni	
C		Epoxy Layer	Ag	
D	Base Metal		Cu	
E	Inner Electrode		Ni	
F	Dielectric Material		BaTiO ₃	

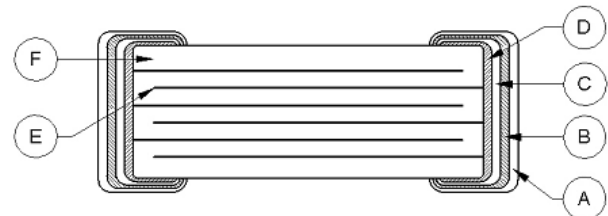

Note: Image is exaggerated in order to clearly identify all components of construction.

KPS Series, High Voltage, X7R Dielectric, 500 VDC – 630 VDC (Commercial Grade)

Overview

KEMET Power Solutions (KPS) High Voltage stacked capacitors utilize a proprietary lead-frame technology to vertically stack one or two multilayer ceramic chip capacitors into a single compact surface mount package. The attached lead-frame mechanically isolates the capacitor(s) from the printed circuit board, thereby offering advanced mechanical and thermal stress performance. Isolation also addresses concerns for audible microphonic noise that may occur when a bias voltage is applied. A two-chip stack offers up to double the capacitance in the same or smaller design footprint when compared to traditional surface mount MLCC devices. Providing up to 10 mm of board flex capability, KPS Series High Voltage capacitors are environmentally friendly and in compliance with RoHS legislation.

KEMET's KPS Series devices in X7R dielectric exhibit a

predictable change in capacitance with respect to time and voltage, and boast a minimal change in capacitance with reference to ambient temperature. Capacitance change is limited to $\pm 15\%$ from -55°C to $+125^{\circ}\text{C}$. These devices are capable of Pb-Free reflow profiles and provide lower ESR, ESL and higher ripple current capability when compared to other dielectric solutions.

Conventional uses include both snubbers and filters in applications such as switching power supplies and lighting ballasts. Their exceptional performance at high frequencies has made high voltage ceramic capacitors the preferred dielectric choice of design engineers worldwide. In addition to their use in power supplies, these capacitors are widely used in industries related to automotive (hybrid), telecommunications, medical, military, aerospace, semiconductors, and test/diagnostic equipment.

Benefits

- -55°C to $+125^{\circ}\text{C}$ operating temperature range
- Reliable and robust termination system
- EIA 2220 case size
- DC voltage ratings of 500 V and 630 V
- Capacitance offerings ranging from $0.047\ \mu\text{F}$ up to $1.0\ \mu\text{F}$
- Available capacitance tolerances of $\pm 10\%$ and $\pm 20\%$
- Higher capacitance in the same footprint
- Potential board space savings
- Advanced protection against thermal and mechanical stress
- Provides up to 10 mm of board flex capability
- Reduces audible microphonic noise
- Extremely low ESR and ESL
- Pb-Free and RoHS Compliant
- Capable of Pb-Free reflow profiles
- Non-polar device, minimizing installation concerns
- Film alternative

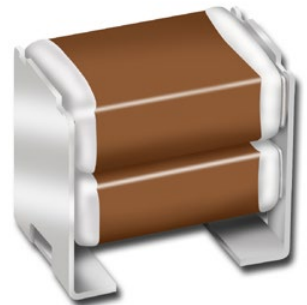

Ordering Information

C	2220	C	105	M	C	R	2	C	7186
Ceramic	Case Size (L"x W")	Specification/ Series	Capacitance Code (pF)	Capacitance Tolerance ¹	Rated Voltage (VDC)	Dielectric	Failure Rate/ Design	Leadframe Finish ²	Packaging/Grade (C-Spec) ³
	2220	C = Standard	2 significant digits + number of zeros.	K = $\pm 10\%$ M = $\pm 20\%$	C = 500 V B = 630 V	R = X7R	1 = KPS Single Chip Stack 2 = KPS Double Chip Stack	C = 100% Matte Sn	7186 = 7" Reel Unmarked 7289 = 13" Reel Unmarked

¹ Double chip stacks ("2" in the 13th character position of the ordering code) are only available in M ($\pm 20\%$) capacitance tolerance.

Single chip stacks ("1" in the 13th character position of the ordering code) are available in K ($\pm 10\%$) or M ($\pm 20\%$) tolerances.

² Additional leadframe finish options may be available. Contact KEMET for details.

³ Additional reeling or packaging options may be available. Contact KEMET for details.

Dimensions – Millimeters (Inches)

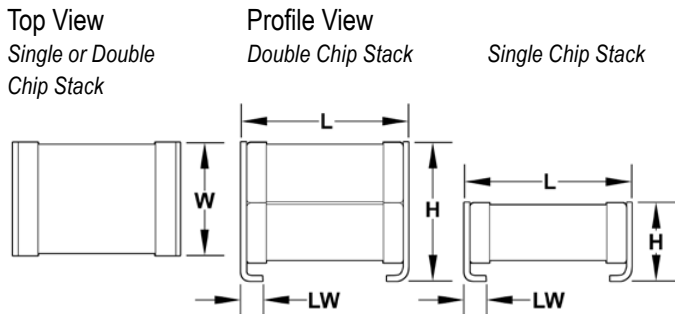

Number of Chips	EIA Size Code	Metric Size Code	L Length	W Width	H Height	LW Lead Width	Mounting Technique
Single	2220	5650	6.00 (0.236) ±0.50 (0.020)	5.00 (.197) ±0.50 (.020)	3.50 (.138) ±0.30 (.012)	1.60 (.063) ±0.30 (.012)	Solder Reflow Only
Double	2220	5650	6.00 (0.236) ±0.50 (0.020)	5.00 (.197) ±0.50 (.020)	5.00 (.197) ±0.50 (.020)	1.60 (.063) ±0.30 (.012)	

Applications

Typical applications include switch mode power supplies (input filters, resonators, tank circuits, snubber circuits, output filters), high voltage coupling and DC blocking, lighting ballasts, voltage multiplier circuits, DC/DC converters and coupling capacitors in Ćuk converters. Markets include power supply, LCD fluorescent backlight ballasts, HID lighting, telecom equipment, industrial and medical equipment/control, LAN/WAN interface, analog and digital modems, and automotive (electric and hybrid vehicles, charging stations and lighting applications).

Application Note

X7R dielectric is not recommended for AC line filtering or pulse applications.

Qualification/Certification

Commercial Grade products are subject to internal qualification. Details regarding test methods and conditions are referenced in Table 4 , Performance and Reliability.

Environmental Compliance

Pb-Free and RoHS Compliant.



RoHS Compliant

Electrical Parameters/Characteristics

Item	Parameters/Characteristics
Operating Temperature Range	-55°C to +125°C
Capacitance Change with Reference to +25°C and 0 VDC Applied (TCC)	±15%
Aging Rate (Maximum % Capacitance Loss/Decade Hour)	3.0%
Dielectric Withstanding Voltage (DWV)	150% of rated voltage for voltage rating of < 1,000 V 120% of rated voltage for voltage rating of ≥ 1,000 V (5 ±1 seconds and charge/discharge not exceeding 50 mA)
Dissipation Factor (DF) Maximum Limit @ 25°C	2.5%
Insulation Resistance (IR) Limit @ 25°C	See Insulation Resistance Limit Table (500 VDC applied for 120 ±5 seconds @ 25°C)

Regarding Aging Rate: Capacitance measurements (including tolerance) are indexed to a referee time of 1,000 hours.

To obtain IR limit, divide $M\Omega - \mu F$ value by the capacitance and compare to $G\Omega$ limit. Select the lower of the two limits.

Capacitance and Dissipation Factor (DF) measured under the following conditions:

1 kHz ±50 Hz and 1.0 ±0.2 Vrms if capacitance ≤ 10 μF

120 Hz ±10 Hz and 0.5 ±0.1 Vrms if capacitance >10 μF

Note: When measuring capacitance it is important to ensure the set voltage level is held constant. The HP4284 and Agilent E4980 have a feature known as Automatic Level Control (ALC). The ALC feature should be switched to "ON."

Post Environmental Limits

High Temperature Life, Biased Humidity, Moisture Resistance					
Dielectric	Rated DC Voltage	Capacitance Value	Dissipation Factor (Maximum %)	Capacitance Shift	Insulation Resistance
X7R	> 25	All	3.0	±20%	10% of Initial Limit
	16/25		5.0		
	< 16		7.5		

Insulation Resistance Limit Table

EIA Case Size	1,000 megohm microfarads or 100 GΩ	100 megohm microfarads or 10 GΩ
0805	< 0.0039 μF	≥ 0.0039 μF
1206	< 0.012 μF	≥ 0.012 μF
1210	< 0.033 μF	≥ 0.033 μF
1808	< 0.018 μF	≥ 0.018 μF
1812	< 0.027 μF	≥ 0.027 μF
≥ 1825	All	N/A

Table 1 – Capacitance Range/Selection Waterfall (2220 Case Sizes)

Capacitance	Capacitance Code	Case Size / Series		C2220C		
		Voltage Code		C	B	D
		Rated Voltage (VDC)		500	630	1000
		Capacitance Tolerance		Product Availability and Chip Thickness Codes – See Table 2 for Chip Thickness Dimensions		
Single Chip Stack						
0.047 μF	473	K	M	JP	JP	
0.10 μF	104	K	M	JP	JP	
0.15 μF	154	K	M	JP	JP	
0.22 μF	224	K	M	JP	JP	
0.33 μF	334	K	M	JP	JP	
0.47 μF	474	K	M	JP		
Double Chip Stack						
0.10 μF	104		M	JR	JR	
0.22 μF	224		M	JR	JR	
0.33 μF	334		M	JR	JR	
0.47 μF	474		M	JR	JR	
0.68 μF	664		M	JR		
1.0 μF	105		M	JR		
Capacitance	Capacitance Code	Rated Voltage (VDC)		500	630	1000
		Voltage Code		C	B	D
		Case Size / Series		C2220C		

Table 2 – Chip Thickness/Packaging Quantities

Thickness Code	Case Size	Thickness ± Range (mm)	Paper Quantity		Plastic Quantity	
			7" Reel	13" Reel	7" Reel	13" Reel
JP	2220	3.50 ± 0.30	0	0	300	1,300
JR	2220	5.00 ± 0.50	0	0	200	800

Package quantity based on finished chip thickness specifications.

Table 3 – KPS Land Pattern Design Recommendations (mm)

EIA SIZE CODE	METRIC SIZE CODE	Median (Nominal) Land Protrusion				
		C	Y	X	V1	V2
1210	3225	1.50	1.14	1.75	5.05	3.40
1812	4532	2.20	1.35	2.87	6.70	4.50
2220	5650	2.69	2.08	4.78	7.70	6.00

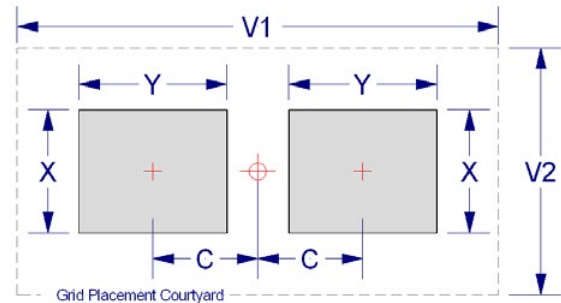

Soldering Process

KEMET's KPS Series devices are compatible with IR reflow techniques. Preheating of these components is recommended to avoid extreme thermal stress. KEMET's recommended profile conditions for IR reflow reflect the profile conditions of the IPC/J-STD-020D standard for moisture sensitivity testing.

To prevent degradation of temperature cycling capability, care must be taken to prevent solder from flowing into the inner side of the lead frames (inner side of "J" lead in contact with the circuit board).

After soldering, the capacitors should be air cooled to room temperature before further processing. Forced air cooling is not recommended.

Hand soldering should be performed with care due to the difficulty in process control. If performed, care should be taken to avoid contact of the soldering iron to the capacitor body. The iron should be used to heat the solder pad, applying solder between the pad and the lead, until reflow occurs. Once reflow occurs, the iron should be removed immediately. (Preheating is required when hand soldering to avoid thermal shock.)

Profile Feature	SnPb Assembly	Pb-Free Assembly
Preheat/Soak		
Temperature Minimum (T_{smin})	100°C	150°C
Temperature Maximum (T_{smax})	150°C	200°C
Time (t_s) from T_{smin} to T_{smax}	60 – 120 seconds	60 – 120 seconds
Ramp-up Rate (T_L to T_p)	3°C/seconds maximum	3°C/seconds maximum
Liquidous Temperature (T_L)	183°C	217°C
Time Above Liquidous (t_L)	60 – 150 seconds	60 – 150 seconds
Peak Temperature (T_p)	235°C	250°C
Time within 5°C of Maximum Peak Temperature (t_p)	20 seconds maximum	10 seconds maximum
Ramp-down Rate (T_p to T_L)	6°C/seconds maximum	6°C/seconds maximum
Time 25°C to Peak Temperature	6 minutes maximum	8 minutes maximum

Note: All temperatures refer to the center of the package, measured on the package body surface that is facing up during assembly reflow.

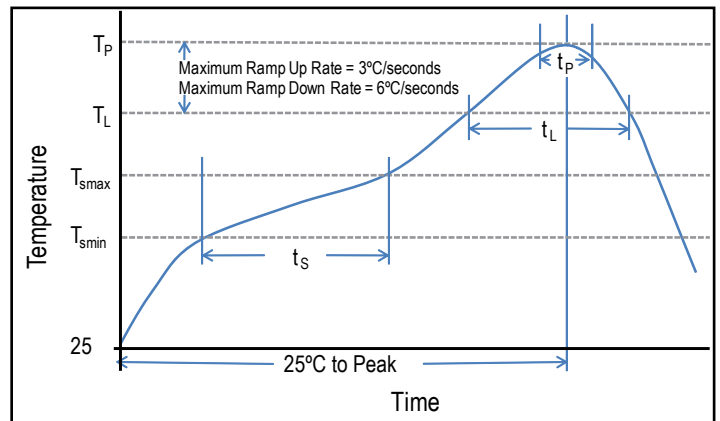

Table 4 – Performance & Reliability: Test Methods and Conditions

Stress	Reference	Test or Inspection Method
Terminal Strength	JIS-C-6429	Appendix 1, Note: Force of 1.8 kg for 60 seconds.
Board Flex	JIS-C-6429	Appendix 2, Note: 5.0 mm minimum
Solderability	J-STD-002	Magnification 50 X. Conditions:
		a) Method B, 4 hours @ 155°C, dry heat @ 235°C
		b) Method B @ 215°C category 3
		c) Method D, category 3 @ 250°C
Temperature Cycling	JESD22 Method JA-104	1,000 cycles (-55°C to +125°C). Measurement at 24 hours +/- 2 hours after test conclusion.
Biased Humidity	MIL-STD-202 Method 103	Load Humidity: 1,000 hours 85°C/85% RH and 200 VDC maximum. Add 100 K ohm resistor. Measurement at 24 hours +/- 2 hours after test conclusion.
		Low Volt Humidity: 1,000 hours 85°C/85% RH and 1.5 V. Add 100 K ohm resistor. Measurement at 24 hours +/- 2 hours after test conclusion.
Moisture Resistance	MIL-STD-202 Method 106	t = 24 hours/cycle. Steps 7a and 7b not required. Unpowered. Measurement at 24 hours +/- 2 hours after test conclusion.
Thermal Shock	MIL-STD-202 Method 107	-55°C/+125°C. Note: Number of cycles required – 300. Maximum transfer time – 20 seconds. Dwell time – 15 minutes. Air-Air.
High Temperature Life	MIL-STD-202 Method 108	1,000 hours at 125°C with rated voltage applied.
Storage Life	MIL-STD-202 Method 108	150°C, 0 VDC for 1,000 hours.
Vibration	MIL-STD-202 Method 204	5 g's for 20 minutes, 12 cycles each of 3 orientations. Note: Use 8" X 5" PCB 0.031" thick, 7 secure points on one long side and 2 secure points at corners of opposite sides. Parts mounted within 2" from any secure point. Test from 10 – 2,000 Hz.
Mechanical Shock	MIL-STD-202 Method 213	Figure 1 of Method 213, Condition F.
Resistance to Solvents	MIL-STD-202 Method 215	Add aqueous wash chemical, OKEM Clean or equivalent.

Storage and Handling

Ceramic chip capacitors should be stored in normal working environments. While the chips themselves are quite robust in other environments, solderability will be degraded by exposure to high temperatures, high humidity, corrosive atmospheres, and long term storage. In addition, packaging materials will be degraded by high temperature– reels may soften or warp and tape peel force may increase. KEMET recommends that maximum storage temperature not exceed 40°C and maximum storage humidity not exceed 70% relative humidity. Temperature fluctuations should be minimized to avoid condensation on the parts and atmospheres should be free of chlorine and sulfur bearing compounds. For optimized solderability chip stock should be used promptly, preferably within 1.5 years of receipt.

Construction

Reference	Item	Material
A	Leadframe	Phosphor Bronze – Alloy 510
B	Leadframe Attach	HMP Solder
C	Termination	Cu
D		Ni
E		Sn
F	Inner Electrode	Ni
G	Dielectric Material	BaTiO ₃

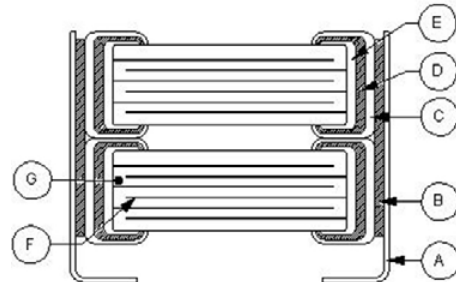

Note: Image is exaggerated in order to clearly identify all components of construction.
 HMP = High Melting Point

Product Marking

Laser marking option is not available on:

- COG, Ultra Stable X8R and Y5V dielectric devices
- EIA 0402 case size devices
- EIA 0603 case size devices with Flexible Termination option.
- KPS Commercial and Automotive grade stacked devices.

These capacitors are supplied unmarked only.

KPS HV, Large Case, SM Series, C0G Dielectric, 500 – 10,000 VDC (Industrial Grade)

Overview

KPS HV (KEMET Power Solutions, High Voltage), Large Case (≥ 1515), SM Series capacitors in C0G dielectric are designed to meet robust performance standards required in higher reliability industrial applications. Utilizing lead-frame technology, SM Series devices isolate the multilayer ceramic chip component from the printed circuit board providing advanced mechanical and thermal stress performance. Isolation of the chip component also addresses concerns for audible, microphonic noise that may occur when a bias voltage is applied. Although this technology does not eliminate the potential for mechanical damage that may propagate during extreme environmental and handling conditions, it does demonstrate superior performance over non-isolating systems. Available in both formed "L" and "J" lead configurations, SM

Series devices offer up to 10 mm of board flex capability and exhibit lower ESR, ESL and higher current discharge capability when compared to other dielectric solutions.

Combined with the stability of an C0G dielectric, KEMET's High Voltage SM Series devices exhibit no change in capacitance with respect to time and voltage and boasts a negligible change in capacitance with reference to ambient temperature. Capacitance change is limited to ± 30 ppm/ $^{\circ}\text{C}$ from -55°C to $+125^{\circ}\text{C}$.

KEMET's Industrial Grade products offer additional screening options for higher reliability applications. Both Group A and Group B testing/inspection options per MIL-PRF-49467 are available for the SM Series.

Benefits

- -55°C to $+125^{\circ}\text{C}$ operating temperature range
- Large Case Sizes (≥ 1515)
- Formed "L" or "J" leadframe configurations.
- Group A and B screening per MIL-PRF-49467 available
- Reliable and robust leadframe termination system
- DC voltage ratings of 500 V, 1 KV, 2 KV, 3 KV, 4 KV, 5 KV, 7.5 KV, and 10 KV
- Capacitance offerings ranging from 10 pF up to 0.39 μF



Ordering Information

SM20		N	472	J	501	B	M
Style/Size		Dielectric	Capacitance Code (pF)	Capacitance Tolerance	Voltage	Lead Configuration ¹	Testing/ Inspection Option ²
SM20	SM30	N = C0G	2 Significant Digits + Number of Zeros	J = $\pm 5\%$	501 = 500 V	A = Formed "L" B = Formed "J"	Blank = None M = Group A per MIL-PRF-49467
SM21	SM31			K = $\pm 10\%$	102 = 1,000 V		
SM22	SM33			M = $\pm 20\%$	202 = 2,000 V		
SM23	SM34			P = +100%, -0%	302 = 3,000 V		
SM24	SM35			Z = +80%, -20%	402 = 4,000 V		
SM25	SM36				502 = 5,000 V		
SM26							

¹ Standard lead configuration is formed "J". If the appropriate character is excluded from the ordering code, the assumed lead configuration will be formed "J".

² Group B testing/inspection option per MIL-PRF-49467 is available upon request. Please contact KEMET for ordering details.

Dimensions – Inches (Millimeters)

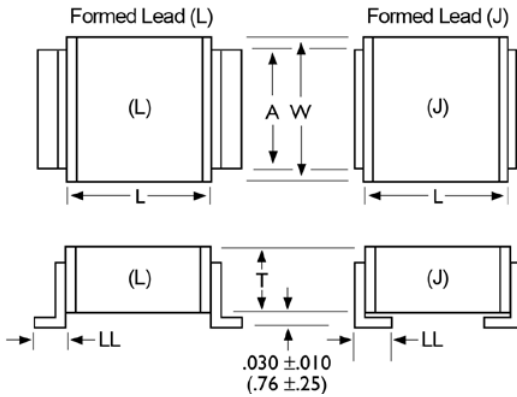

Style/ Size	L Length	W Width	T Thickness Maximum	A Lead Width Maximum	LL Lead Length (Formed "L")	LL Lead Length (Formed "J")
SM20	0.150 ± 0.015 (3.81 ± 0.38)	0.150 ± 0.015 (3.81 ± 0.38)	0.130 (3.30)	0.100 (2.54)	0.100 ± 0.020 (2.54 ± 0.51)	0.040 ± 0.010 (1.02 ± 0.25)
SM21	0.200 ± 0.020 (5.08 ± 0.51)	0.200 ± 0.020 (5.08 ± 0.51)	0.180 (4.57)			
SM22	0.250 ± 0.020 (6.35 ± 0.51)	0.200 ± 0.020 (5.08 ± 0.51)	0.220 (5.59)			0.200 (5.08)
SM23	0.350 ± 0.030 (8.89 ± 0.76)	0.300 ± 0.030 (7.62 ± 0.76)		0.300 (7.62)		
SM24	0.450 ± 0.030 (11.43 ± 0.76)	0.400 ± 0.030 (10.20 ± 0.76)		0.400 (10.20)		
SM25	0.550 ± 0.030 (14.00 ± 0.76)	0.500 ± 0.030 (12.70 ± 0.76)		0.500 (12.70)		
SM26	0.650 ± 0.030 (16.50 ± 0.76)	0.600 ± 0.030 (15.20 ± 0.76)	0.140 (3.55)	0.100 (2.54)		0.100 ± 0.020 (2.54 ± 0.51)
SM30	0.300 ± 0.030 (7.62 ± 0.76)	0.150 ± 0.015 (3.81 ± 0.38)	0.130 (3.30)			
SM31	0.400 ± 0.030 (10.20 ± 0.76)	0.200 ± 0.020 (5.08 ± 0.51)	0.180 (4.57)	0.200 (5.08)		
SM33	0.700 ± 0.030 (17.08 ± 0.76)	0.300 ± 0.030 (7.62 ± 0.76)	0.220 (5.59)	0.300 (7.62)		
SM34	0.900 ± 0.030 (22.90 ± 0.76)	0.400 ± 0.030 (10.20 ± 0.76)		0.400 (10.2)		
SM35	1.100 ± 0.030 (27.90 ± 0.76)	0.500 ± 0.030 (12.70 ± 0.76)		0.500 (12.7)		
SM36	1.350 ± 0.030 (33.00 ± 0.76)	0.600 ± 0.030 (15.20 ± 0.76)				

Benefits cont'd

- Advanced protection against thermal and mechanical stress
- Provides up to 10 mm of board flex capability
- Reduces audible, microphonic noise
- Low ESR and ESL
- Non-polar device, minimizing installation concerns
- Silver plated copper alloy leadframe termination system

Applications

Typical applications include switch mode power supplies (input filters, resonators, tank circuits, snubber circuits, output filters), high voltage coupling and DC blocking, voltage multiplier circuits, DC/DC converters and coupling capacitors in Ćuk converters, noise reduction (piezoelectric/mechanical), circuits with a direct battery or power source connection, critical and safety relevant circuits without (integrated) current limitation and any application that is subject to high levels of board flexure or temperature cycling. Markets include power supply, LCD fluorescent backlight ballasts, HID lighting, telecom equipment, industrial and medical equipment/control and Military.

Qualification/Certification

Industrial Grade products are subject to internal qualification. Details regarding test methods and conditions are referenced in Table 3, Performance & Reliability.

Environmental Compliance

RoHS Compliant with Exemption(s)



RoHS Compliant

Electrical Parameters/Characteristics

Item	Parameters/Characteristics
Operating Temperature Range	-55°C to +125°C
Capacitance Change with Reference to +25°C and 0 VDC Applied (TCC)	±30 ppm/°C
Aging Rate (Maximum % Capacitance Loss/Decade Hour)	0%
Dielectric Withstanding Voltage (DWV)	150% of rated voltage for voltage rating of ≤ 1,250 VDC 120% of rated voltage for voltage rating of > 1,250 VDC (5 ±1 seconds and charge/discharge not exceeding 50 mA)
Dissipation Factor (DF) Maximum Limit @ 25°C	0.15%
Insulation Resistance (IR) Limit @ 25°C	1,000 megohm microfarads or 100 GΩ (Rated voltage DC applied for 120 ±5 seconds @ 25°C for voltage rating of ≤ 500 VDC) (500 VDC applied for 120 ±5 seconds @ 25°C for voltage rating of > 500 VDC)

To obtain IR limit, divide MΩ-μF value by the capacitance and compare to GΩ limit. Select the lower of the two limits.

Capacitance and dissipation factor (DF) measured under the following conditions:

1 MHz ±100 kHz and 1.0 Vrms ±0.2 V if capacitance ≤ 100 pF

1 kHz ±50 Hz and 1.0 Vrms ±0.2 V if capacitance > 100 pF

Note: When measuring capacitance it is important to ensure the set voltage level is held constant. The HP4284 and Agilent E4980 have a feature known as Automatic Level Control (ALC). The ALC feature should be switched to "ON."

Post Environmental Limits

High Temperature Life, Biased Humidity, Moisture Resistance					
Dielectric	Rated DC Voltage	Capacitance Value	Dissipation Factor (Maximum %)	Capacitance Shift	Insulation Resistance
COG	All	All	0.5	0.3% or ±0.25 pF	10% of Initial Limit

Table 1D – Capacitance Range/Selection Waterfall SM36 Style/Size

Style/Size	SM36									Capacitance Tolerance
Dimensions – inches (mm)										
Length	1.350 ± 0.030 (33.00 ± 0.76)									
Width	0.600 ± 0.030 (15.20 ± 0.76)									
Thickness Maximum	0.220 (5.59)									
Lead Width Maximum	0.500 (12.7)									
Lead Length "L"	0.100 ± 0.020 (2.54 ± 0.51)									
Lead Length "J"	0.100 ± 0.020 (2.54 ± 0.51)									
COG Dielectric										
Voltage Code	501	102	202	302	402	502	752	103		
Voltage DC	500	1K	2K	3K	4K	5K	7.5K	10K		
Capacitance	Capacitance Code									
120 pF					121	121	121			J, K, M, P, Z
150 pF	151	151	151	151	151	151	151			
180 pF	181	181	181	181	181	181	181			
220 pF	221	221	221	221	221	221	221			
270 pF	271	271	271	271	271	271	271			
330 pF	331	331	331	331	331	331	331			
390 pF	391	391	391	391	391	391	391			
470 pF	471	471	471	471	471	471	471			
560 pF	561	561	561	561	561	561	561			
680 pF	681	681	681	681	681	681	681			
820 pF	821	821	821	821	821	821	821	102		
1,000 pF	102	102	102	102	102	102	102		102	
1,200 pF	122	122	122	122	122	122	122			
1,500 pF	152	152	152	152	152	152	152		152	
1,800 pF	182	182	182	182	182	182	182			
2,200 pF	222	222	222	222	222	222	222			
2,700 pF	272	272	272	272	272	272	272			
3,300 pF	332	332	332	332	332	332	332			
3,900 pF	392	392	392	392	392	392				
4,700 pF	472	472	472	472	472	472				
5,600 pF	562	562	562	562	562	562				
6,800 pF	682	682	682	682	682	682				
8,200 pF	822	822	822	822	822					
0.01 µF	103	103	103	103	103					
0.012 µF	123	123	123	123						
0.015 µF	153	153	153	153						
0.018 µF	183	183	183	183						
0.022 µF	223	223	223	223						
0.027 µF	273	273	273	273						
0.033 µF	333	333	333	333						
0.039 µF	393	393	393							
0.047 µF	473	473	473							
0.056 µF	563	563	563							
0.068 µF	683	683								
0.082 µF	823	823								
0.1 µF	104	104								
0.12 µF	124	124								
0.15 µF	154	154								
0.18 µF	184									
0.22 µF	224									
0.27 µF	274									
0.33 µF	334									
0.39 µF	394									

Table 2 – Chip Thickness/Packaging Quantities

Series	Style/Size	Tray Quantity Minimum ¹	Tray Quantity Maximum ¹
SM	SM20	1	50
	SM21		
	SM22		
	SM23		
	SM24		
	SM25		
	SM26		
	SM30		
	SM31		
	SM33		
	SM34	10	
	SM35		
	SM36		

¹ Minimum order value applies. Contact KEMET for details.

Soldering Process

The capacitors and assemblies outlined in this specification sheet are susceptible to thermal shock damage due to their large ceramic mass. Temperature profiles used should provide adequate temperature rise and cool-down time to prevent damage from thermal shock. In general, KEMET recommends against hand soldering for these types of large ceramic devices.

Recommended Soldering Technique:

- Solder reflow only

Preheating and Reflow Profile Notes:

Due to differences in the coefficient of thermal expansion for the different materials of construction, it is critical to monitor and control the heating and cooling rates during the soldering process. During the reflow soldering process, the maximum recommended heating and cooling rate (dT/dt) is 4°C/second. To ensure optimal component reliability, KEMET's recommended heating and cooling rate is 2°C/second. After soldering, the capacitors should be air cooled to room temperature before further processing. Forced air cooling is not recommended.

Recommended Reflow Soldering Profile:

Profile Feature	SnPb Assembly
Preheat/Soak	
Temperature Minimum (T_{Smin})	100°C
Temperature Maximum (T_{Smax})	150°C
Time (t_s) from T_{Smin} to T_{Smax}	60 – 90 seconds
Ramp-up Rate (T_L to T_p)	2°C/seconds
Liquidous Temperature (T_L)	183°C
Time Above Liquidous (t_L)	95 seconds
Peak Temperature (T_p)	240°C
Time within 5°C of Maximum Peak Temperature (t_p)	5 seconds
Ramp-down Rate (T_p to T_L)	2°C/seconds
Time 25°C to Peak Temperature	3.5 minutes

Note 1: All temperatures refer to the center of the package, measured on the package body surface that is facing up during assembly reflow.

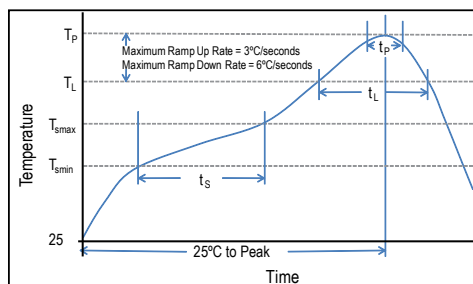

Table 3 – Performance & Reliability: Test Methods and Conditions

Stress	Reference	Test or Inspection Method
Board Flex	JIS-C-6429	Appendix 2, Note: 2 mm (minimum) for all except 3 mm for COG.
Solderability	J-STD-002	Magnification 50 X. Conditions:
		a) Method B, 4 hours @ 155°C, dry heat @ 235°C
		b) Method B @ 215°C category 3
		c) Method D, category 3 @ 260°C
		1,000 cycles (-55°C to +125°C). Measurement at 24 hours +/- 2 hours after test conclusion.
Biased Humidity	MIL-STD-202 Method 103	Load Humidity: 1,000 hours 85°C/85% RH and 300 VDC Maximum Add 100 K ohm resistor. Measurement at 24 hours +/- 2 hours after test conclusion.
		Low Volt Humidity: 1,000 hours 85°C/85% RH and 1.5 V. Add 100 K ohm resistor. Measurement at 24 hours +/- 2 hours after test conclusion.
		t = 24 hours/cycle. Steps 7a and 7b not required. Unpowered. Measurement at 24 hours +/- 2 hours after test conclusion.
Thermal Shock	MIL-STD-202 Method 107	-55°C/+125°C. Note: Number of cycles required – 300. Maximum transfer time – 20 seconds. D14 dwell time – 15 minutes. Air – Air.
High Temperature Life	MIL-STD-202 Method 108 /EIA -198	1,000 hours at 125°C (85°C for X5R, Z5U and Y5V) with rated voltage applied.
Storage Life	MIL-STD-202 Method 108	150°C, 0 VDC, for 1,000 hours.
Vibration	MIL-STD-202 Method 204	5 g for 20 minutes, 12 cycles each of 3 orientations. Note: Use 8 "X5" PCB 0.031" thick 7 secure points on one long side and 2 secure points at corners of opposite sides. Parts mounted within 2" from any secure point. Test from 10–2,000 Hz.
Resistance to Soldering Heat	MIL-STD-202 Method 210	Condition B. No preheat of samples. Note: single wave solder – procedure 2.
Terminal Strength	MIL-STD-202 Method 211	Conditions A (2.3 kg or 5 lbs).
Mechanical Shock	MIL-STD-202 Method 213	Figure 1 of Method 213, Condition F.
Resistance to Solvents	MIL-STD-202 Method 215	Add aqueous wash chemical, OKEM Clean or equivalent.

Storage and Handling

Ceramic chip capacitors should be stored in normal working environments. While the chips themselves are quite robust in other environments, solderability will be degraded by exposure to high temperatures, high humidity, corrosive atmospheres, and long term storage. In addition, packaging materials will be degraded by high temperature– reels may soften or warp and tape peel force may increase. KEMET recommends that maximum storage temperature not exceed 40°C and maximum storage humidity not exceed 70% relative humidity. Temperature fluctuations should be minimized to avoid condensation on the parts and atmospheres should be free of chlorine and sulfur bearing compounds. For optimized solderability chip stock should be used promptly, preferably within 1.5 years of receipt.

Construction

Reference	Item	Material
A	Leadframe	Phosphor Bronze - Alloy 510 (Silver plated / Nickle Underplate)
B	Leadframe Attach Material	Silver Epoxy
C	MLCC Termination System	Solderable Silver
D		
E		
F	Electrode	PdAg
G	Dielectric	BaTiO ₃

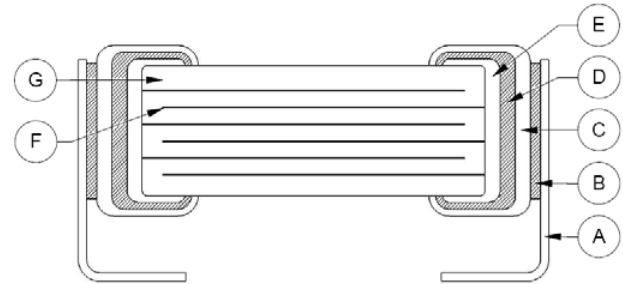

Note: Image is exaggerated in order to clearly identify all components of construction

Product Marking

Product marking is an extra-cost option. These devices will be supplied unmarked unless otherwise specified and/or requested. For more detailed information regarding marked product and how to request this option, please contact KEMET.

KPS HV, Large Case, SM Series, X7R Dielectric, 500 – 10,000 VDC (Industrial Grade)

Overview

KPS HV (KEMET Power Solutions, High Voltage), Large Case (≥ 1515), SM Series capacitors in X7R dielectric are designed to meet robust performance standards required in higher reliability industrial applications. Utilizing lead-frame technology, SM Series devices isolate the multilayer ceramic chip component from the printed circuit board providing advanced mechanical and thermal stress performance. Isolation of the chip component also addresses concerns for audible, microphonic noise that may occur when a bias voltage is applied. Although this technology does not eliminate the potential for mechanical damage that may propagate during extreme environmental and handling conditions, it does demonstrate superior performance over non-isolating systems. Available in both formed "L" and "J" lead configurations, SM Series devices offer up to 10 mm

of board flex capability and exhibit lower ESR, ESL and higher current discharge capability when compared to other dielectric solutions.

Combined with the stability of an X7R dielectric, KEMET's High Voltage SM Series devices exhibit a predictable change in capacitance with respect to time and voltage and boast a minimal change in capacitance with reference to ambient temperature. Capacitance change is limited to $\pm 15\%$ from -55°C to $+125^{\circ}\text{C}$.

KEMET's Industrial grade products offer additional screening options for higher reliability applications. Both Group A and Group B testing/inspection options per MIL-PRF-49467 are available for the SM Series.

Benefits

- -55°C to $+125^{\circ}\text{C}$ operating temperature range
- Large Case Sizes (≥ 1515)
- Formed "L" or "J" leadframe configurations
- Group A and B screening per MIL-PRF-49467 available
- Reliable and robust leadframe termination system
- DC voltage ratings of 500 V, 1 KV, 2 KV, 3 KV, 4 KV, 5 KV, 7.5 KV, and 10 KV
- Capacitance offerings ranging from 150 pF up to 5.6 μF



Ordering Information

SM20		B	153	K	501	B	M
Style/Size		Dielectric	Capacitance Code (pF)	Capacitance Tolerance	Voltage	Lead Configuration ¹	Testing/ Inspection Option ²
SM20	SM30	B = X7R	2 Significant Digits + Number of Zeros	K = $\pm 10\%$ M = $\pm 20\%$	501 = 500 V	A = Formed "L" B = Formed "J"	Blank = None M = Group A per MIL-PRF-49467
SM21	SM31				102 = 1,000 V		
SM22	SM33				202 = 2,000 V		
SM23	SM34				302 = 3,000 V		
SM24	SM35				402 = 4,000 V		
SM25	SM36				502 = 5,000 V		
SM26							

¹ Standard lead configuration is formed "J". If the appropriate character is excluded from the ordering code, the assumed lead configuration will be formed "J".

² Group B testing/inspection option per MIL-PRF-49467 is available upon request. Please contact KEMET for ordering details.

Dimensions – Inches (Millimeters)

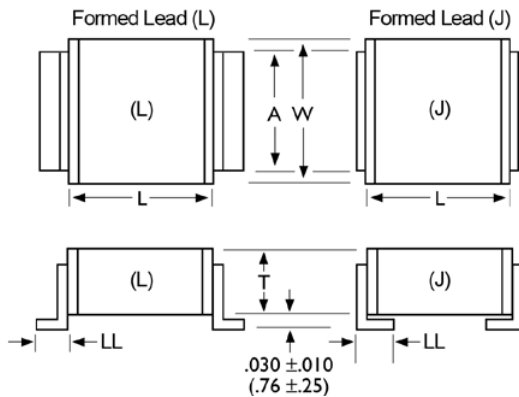

Style/ Size	L Length	W Width	T Thickness Max.	A Lead Width Max.	LL Lead Length (Formed "L")	LL Lead Length (Formed "J")	
SM20	0.150 ± 0.015 (3.81 ± 0.38)	0.150 ± 0.015 (3.81 ± 0.38)	0.130 (3.30)	0.100 (2.54)	0.100 ± 0.020 (2.54 ± 0.51)	0.040 ± 0.010 (1.02 ± 0.25)	
SM21	0.200 ± 0.020 (5.08 ± 0.51)	0.200 ± 0.020 (5.08 ± 0.51)	0.180 (4.57)				
SM22	0.250 ± 0.020 (6.35 ± 0.51)	0.200 ± 0.020 (5.08 ± 0.51)					
SM23	0.350 ± 0.030 (8.89 ± 0.76)	0.300 ± 0.030 (7.62 ± 0.76)	0.220 (5.59)	0.200 (5.08)		0.100 ± 0.020 (2.54 ± 0.51)	0.100 ± 0.020 (2.54 ± 0.51)
SM24	0.450 ± 0.030 (11.43 ± 0.76)	0.400 ± 0.030 (10.20 ± 0.76)		0.300 (7.62)			
SM25	0.550 ± 0.030 (14.00 ± 0.76)	0.500 ± 0.030 (12.70 ± 0.76)		0.400 (10.20)			
SM26	0.650 ± 0.030 (16.50 ± 0.76)	0.600 ± 0.030 (15.20 ± 0.76)		0.500 (12.70)			
SM30	0.300 ± 0.030 (7.62 ± 0.76)	0.150 ± 0.015 (3.81 ± 0.38)	0.140 (3.55)	0.100 (2.54)			
SM31	0.400 ± 0.030 (10.20 ± 0.76)	0.200 ± 0.020 (5.08 ± 0.51)	0.130 (3.30)				
SM33	0.700 ± 0.030 (17.08 ± 0.76)	0.300 ± 0.030 (7.62 ± 0.76)	0.180 (4.57)	0.200 (5.08)			
SM34	0.900 ± 0.030 (22.90 ± 0.76)	0.400 ± 0.030 (10.20 ± 0.76)	0.220 (5.59)	0.300 (7.62)			
SM35	1.100 ± 0.030 (27.90 ± 0.76)	0.500 ± 0.030 (12.70 ± 0.76)		0.400 (10.2)			
SM36	1.350 ± 0.030 (33.00 ± 0.76)	0.600 ± 0.030 (15.20 ± 0.76)		0.500 (12.7)			

Benefits cont'd

- Advanced protection against thermal and mechanical stress
- Provides up to 10 mm of board flex capability
- Reduces audible, microphonic noise
- Low ESR and ESL
- Non-polar device, minimizing installation concerns
- Silver plated copper alloy leadframe termination system

Applications

Typical applications include switch mode power supplies (input filters, resonators, tank circuits, snubber circuits, output filters), high voltage coupling and DC blocking, voltage multiplier circuits, DC/DC converters and coupling capacitors in Ćuk converters, noise reduction (piezoelectric/mechanical), circuits with a direct battery or power source connection, critical and safety relevant circuits without (integrated) current limitation and any application that is subject to high levels of board flexure or temperature cycling. Markets include power supply, LCD fluorescent backlight ballasts, HID lighting, telecom equipment, industrial and medical equipment/control and Military.

Qualification/Certification

Industrial Grade products are subject to internal qualification. Details regarding test methods and conditions are referenced in Table 3, Performance & Reliability.

Environmental Compliance

RoHS compliant with Exemption(s)



RoHS Compliant

Electrical Parameters/Characteristics

Item	Parameters/Characteristics
Operating Temperature Range	-55°C to +125°C
Capacitance Change with Reference to +25°C and 0 VDC Applied (TCC)	±15%
Aging Rate (Maximum % Capacitance Loss/Decade Hour)	3.0%
Dielectric Withstanding Voltage (DWV)	150% of rated voltage for voltage rating of ≤ 1,250 VDC 120% of rated voltage for voltage rating of > 1,250 VDC (5 ±1 seconds and charge/discharge not exceeding 50 mA)
Dissipation Factor (DF) Maximum Limit @ 25°C	2.5%
Insulation Resistance (IR) Limit @ 25°C	1,000 megohm microfarads or 100 GΩ (Rated voltage DC applied for 120 ±5 seconds @ 25°C for voltage rating of ≤ 500 VDC) (500 VDC applied for 120 ±5 seconds @ 25°C for voltage rating of > 500 VDC)

Regarding aging rate: Capacitance measurements (including tolerance) are indexed to a referee time of 1,000 hours.

To obtain IR limit, divide $M\Omega \cdot \mu F$ value by the capacitance and compare to $G\Omega$ limit. Select the lower of the two limits.

Capacitance and dissipation factor (DF) measured under the following conditions:

1 kHz ±50 Hz and 1.0 Vrms ±0.2 V if capacitance > 100 pF

Note: When measuring capacitance it is important to ensure the set voltage level is held constant. The HP4284 and Agilent E4980 have a feature known as Automatic Level Control (ALC). The ALC feature should be switched to "ON."

Post Environmental Limits

High Temperature Life, Biased Humidity, Moisture Resistance				
Dielectric	Rated DC Voltage	Capacitance Value	Dissipation Factor (Maximum %)	Capacitance Shift
X7R	All	All	3.0	±20%

Table 1A – Capacitance Range/Selection Waterfall SM20 – SM24 Style/Size

Style/Size	SM20			SM21				SM22				SM23				SM24							
Dimensions – inches (mm)																							
Length	0.150 ± 0.015 (3.81 ± 0.38)			0.200 ± 0.020 (5.08 ± 0.51)				0.250 ± 0.020 (6.35 ± 0.51)				0.350 ± 0.030 (8.89 ± 0.76)				0.450 ± 0.030 (11.43 ± 0.76)							
Width	0.150 ± 0.015 (3.81 ± 0.38)			0.200 ± 0.020 (5.08 ± 0.51)				0.200 ± 0.020 (5.08 ± 0.51)				0.300 ± 0.030 (7.62 ± 0.76)				0.400 ± 0.030 (10.20 ± 0.76)							
Thickness Maximum	0.130 (3.30)			0.180 (4.57)				0.180 (4.57)				0.220 (5.59)				0.220 (5.59)							
Lead Width Maximum	0.100 (2.54)			0.100 (2.54)				0.100 (2.54)				0.200 (5.08)				0.300 (7.62)							
Lead Length "L"	0.100 ± 0.020 (2.54 ± 0.51)			0.100 ± 0.020 (2.54 ± 0.51)				0.100 ± 0.020 (2.54 ± 0.51)				0.100 ± 0.020 (2.54 ± 0.51)				0.100 ± 0.020 (2.54 ± 0.51)							
Lead Length "J"	0.040 ± 0.010 (1.02 ± 0.25)			0.040 ± 0.010 (1.02 ± 0.25)				0.040 ± 0.010 (1.02 ± 0.25)				0.100 ± 0.020 (2.54 ± 0.51)				0.100 ± 0.020 (2.54 ± 0.51)							
X7R Dielectric																							
Voltage Code	501	102	202	501	102	202	302	501	102	202	302	501	102	202	302	402	501	102	202	302	402	502	
Voltage DC	500	1 K	2 K	500	1 K	2 K	3 K	500	1 K	2 K	3 K	500	1 K	2 K	3 K	4 K	500	1 K	2 K	3 K	4 K	5 K	
Capacitance	Capacitance Code																						
330 pF	331	331	331																				
390 pF	391	391	391																				
470 pF	471	471	471																				
560 pF	561	561	561																				
680 pF	681	681	681					681	681	681	681												
820 pF	821	821	821	821	821	821	821	821	821	821	821												
1,000 pF	102	102	102	102	102	102	102	102	102	102	102	102	102	102	102	102	102	102	102	102	102	102	
1,200 pF	122	122	122	122	122	122	122	122	122	122	122	122	122	122	122	122	122	122	122	122	122	122	
1,500 pF	152	152	152	152	152	152	152	152	152	152	152	152	152	152	152	152	152	152	152	152	152	152	
1,800 pF	182	182	182	182	182	182	182	182	182	182	182	182	182	182	182	182	182	182	182	182	182	182	
2,200 pF	222	222	222	222	222	222	222	222	222	222	222	222	222	222	222	222	222	222	222	222	222	222	
2,700 pF	272	272	272	272	272	272	272	272	272	272	272	272	272	272	272	272	272	272	272	272	272	272	
3,300 pF	332	332	332	332	332	332	332	332	332	332	332	332	332	332	332	332	332	332	332	332	332	332	
3,900 pF	392	392	392	392	392	392	392	392	392	392	392	392	392	392	392	392	392	392	392	392	392	392	
4,700 pF	472	472		472	472	472	472	472	472	472	472	472	472	472	472	472	472	472	472	472	472	472	
5,600 pF	562	562		562	562	562		562	562	562	562						562	562	562	562	562	562	
6,800 pF	682	682		682	682	682		682	682	682						682	682	682	682	682	682	682	
8,200 pF	822	822		822	822	822		822	822	822						822	822	822	822	822	822	822	
0.01 µF	103	103		103	103	103		103	103	103						103	103	103	103	103	103	103	
0.012 µF	123	123		123	123	123		123	123	123						123	123	123	123	123	123	123	
0.015 µF	153	153		153	153			153	153	153						153	153	153	153				
0.018 µF	183	183		183	183			183	183							183	183	183	183				
0.022 µF	223	223		223	223			223	223							223	223	223	223				
0.027 µF	273			273	273			273	273							273	273	273	273				
0.033 µF	333			333	333			333	333							333	333	333	333				
0.039 µF	393			393	393			393	393							393	393	393					
0.047 µF	473			473	473			473	473							473	473	473					
0.056 µF	563			563	563			563	563							563	563	563					
0.068 µF	683			683	683			683	683							683	683	683					
0.082 µF	823			823				823	823							823	823	823					
0.1 µF				104				104	104							104	104		104				
0.12 µF				124				124								124	124		124				
0.15 µF				154				154								154	154		154				
0.18 µF				184				184								184	184		184				
0.22 µF								224								224	224		224				
0.27 µF								274								274	274		274				
0.33 µF																334			334				
0.39 µF																394			394				
0.47 µF																474			474				
0.56 µF																564			564				
0.68 µF																			684				
0.82 µF																			824				
1.0 µF																			105				
1.2 µF																			125				

K, M

Table 1B – Capacitance Range/Selection Waterfall SM25 – SM31 Style/Size

Style/Size	SM25					SM26					SM30					SM31											
Dimensions – inches (mm)																											
Length	0.550 ± 0.030 (14.00 ± 0.76)					0.650 ± 0.030 (16.50 ± 0.76)					0.300 ± 0.030 (7.62 ± 0.76)					0.400 ± 0.030 (10.20 ± 0.76)											
Width	0.500 ± 0.030 (12.70 ± 0.76)					0.600 ± 0.030 (15.20 ± 0.76)					0.150 ± 0.015 (3.81 ± 0.38)					0.200 ± 0.020 (5.08 ± 0.51)											
Thickness Maximum	0.220 (5.59)					0.220 (5.59)					0.140 (3.55)					0.130 (3.30)											
Lead Width Maximum	0.400 (10.20)					0.500 (12.70)					0.100 (2.54)					0.100 (2.54)											
Lead Length "L"	0.100 ± 0.020 (2.54 ± 0.51)					0.100 ± 0.020 (2.54 ± 0.51)					0.100 ± 0.020 (2.54 ± 0.51)					0.100 ± 0.020 (2.54 ± 0.51)											
Lead Length "J"	0.100 ± 0.020 (2.54 ± 0.51)					0.100 ± 0.020 (2.54 ± 0.51)					0.100 ± 0.020 (2.54 ± 0.51)					0.100 ± 0.020 (2.54 ± 0.51)											
X7R Dielectric																											
Voltage Code	501	102	202	302	402	502	501	102	202	302	402	502	501	102	202	302	402	501	102	202	302	402	502	Capacitance Tolerance			
Voltage DC	500	1 K	2 K	3 K	4 K	5 K	500	1 K	2 K	3 K	4 K	5 K	500	1 K	2 K	3 K	4 K	500	1 K	2 K	3 K	4 K	5 K				
Capacitance	Capacitance Code																										
150 pF													151	151	151	151	151										
180 pF													181	181	181	181	181										
220 pF													221	221	221	221	221										
270 pF													271	271	271	271	271										
330 pF													331	331	331	331	331										
390 pF													391	391	391	391	391										
470 pF													471	471	471	471	471										
560 pF													561	561	561	561	561										
680 pF													681	681	681	681	681	681	681	681	681	681	681	681	681	681	681
820 pF													821	821	821	821	821	821	821	821	821	821	821	821	821	821	821
1,000 pF													102	102	102	102	102	102	102	102	102	102	102	102	102	102	102
1,200 pF													122	122	122	122	122	122	122	122	122	122	122	122	122	122	122
1,500 pF													152	152	152	152	152	152	152	152	152	152	152	152	152	152	152
1,800 pF													182	182	182	182	182	182	182	182	182	182	182	182	182	182	182
2,200 pF	222	222	222	222	222	222	222	222	222	222			222	222	222	222	222	222	222	222	222	222	222	222	222	222	222
2,700 pF	272	272	272	272	272	272	272	272	272	272			272	272	272	272	272	272	272	272	272	272	272	272	272	272	272
3,300 pF	332	332	332	332	332	332	332	332	332	332			332	332	332	332	332	332	332	332	332	332	332	332	332	332	332
3,900 pF	392	392	392	392	392	392	392	392	392	392	392	392	392	392	392	392	392	392	392	392	392	392	392	392	392	392	392
4,700 pF	472	472	472	472	472	472	472	472	472	472	472	472	472	472	472	472	472	472	472	472	472	472	472	472	472	472	472
5,600 pF	562	562	562	562	562	562	562	562	562	562	562	562	562	562	562	562	562	562	562	562	562	562	562	562	562	562	562
6,800 pF	682	682	682	682	682	682	682	682	682	682	682	682	682	682	682	682	682	682	682	682	682	682	682	682	682	682	682
8,200 pF	822	822	822	822	822	822	822	822	822	822	822	822	822	822	822	822	822	822	822	822	822	822	822	822	822	822	822
0.01 µF	103	103	103	103	103	103	103	103	103	103	103	103	103	103	103	103	103	103	103	103	103	103	103	103	103	103	103
0.012 µF	123	123	123	123	123								123	123	123	123	123	123	123	123	123	123	123	123	123	123	123
0.015 µF	153	153	153	153	153								153	153	153	153	153	153	153	153	153	153	153	153	153	153	153
0.018 µF	183	183	183	183									183	183	183	183	183	183	183	183	183	183	183	183	183	183	183
0.022 µF	223	223	223	223									223	223	223	223	223	223	223	223	223	223	223	223	223	223	223
0.027 µF	273	273	273	273									273	273	273	273	273	273	273	273	273	273	273	273	273	273	273
0.033 µF	333	333	333	333									333	333	333	333	333	333	333	333	333	333	333	333	333	333	333
0.039 µF	393	393	393	393									393	393	393	393	393	393	393	393	393	393	393	393	393	393	393
0.047 µF	473	473	473	473									473	473	473	473	473	473	473	473	473	473	473	473	473	473	473
0.056 µF	563	563	563										563	563	563	563	563	563	563	563	563	563	563	563	563	563	563
0.068 µF	683	683	683										683	683	683	683	683	683	683	683	683	683	683	683	683	683	683
0.082 µF	823	823	823										823	823	823	823	823	823	823	823	823	823	823	823	823	823	823
0.1 µF	104	104	104										104	104	104	104	104	104	104	104	104	104	104	104	104	104	104
0.12 µF	124	124	124										124	124	124												
0.15 µF	154	154											154	154	154												
0.18 µF	184	184											184	184	184												
0.22 µF	224	224											224	224													
0.27 µF	274	274											274	274													
0.33 µF	334	334											334	334													
0.39 µF	394	394											394	394													
0.47 µF	474	474											474	474													
0.56 µF	564												564	564													
0.68 µF	684												684	684													
0.82 µF	824												824	824													

Table 1B – Capacitance Range/Selection Waterfall SM25 – SM31 Style/Size cont'd

Style/Size	SM25					SM26					SM30					SM31									
Dimensions – inches (mm)																									
Length	0.550 ± 0.030 (14.00 ± 0.76)					0.650 ± 0.030 (16.50 ± 0.76)					0.300 ± 0.030 (7.62 ± 0.76)					0.400 ± 0.030 (10.20 ± 0.76)									
Width	0.500 ± 0.030 (12.70 ± 0.76)					0.600 ± 0.030 (15.20 ± 0.76)					0.150 ± 0.015 (3.81 ± 0.38)					0.200 ± 0.020 (5.08 ± 0.51)									
Thickness Maximum	0.220 (5.59)					0.220 (5.59)					0.140 (3.55)					0.130 (3.30)									
Lead Width Maximum	0.400 (10.20)					0.500 (12.70)					0.100 (2.54)					0.100 (2.54)									
Lead Length "L"	0.100 ± 0.020 (2.54 ± 0.51)					0.100 ± 0.020 (2.54 ± 0.51)					0.100 ± 0.020 (2.54 ± 0.51)					0.100 ± 0.020 (2.54 ± 0.51)									
Lead Length "J"	0.100 ± 0.020 (2.54 ± 0.51)					0.100 ± 0.020 (2.54 ± 0.51)					0.100 ± 0.020 (2.54 ± 0.51)					0.100 ± 0.020 (2.54 ± 0.51)									
X7R Dielectric																									
Voltage Code	501	102	202	302	402	502	501	102	202	302	402	502	501	102	202	302	402	501	102	202	302	402	502	Capacitance Tolerance	
Voltage DC	500	1 K	2 K	3 K	4 K	5 K	500	1 K	2 K	3 K	4 K	5 K	500	1 K	2 K	3 K	4 K	500	1 K	2 K	3 K	4 K	5 K		
Capacitance	Capacitance Code																								
1.0 µF	105						105	105																K, M	
1.2 µF	125						125																		
1.5 µF	155						155																		
1.8 µF	185						185																		
2.2 µF							225																		
2.7 µF							275																		
2.9 µF							295																		

Table 1C – Capacitance Range/Selection Waterfall SM33 – SM35 Style/Size

Style/Size	SM33							SM34							SM35							Capacitance Tolerance		
Dimensions – inches (mm)																								
Length	0.700 ± 0.030 (17.08 ± 0.76)							0.900 ± 0.030 (22.90 ± 0.76)							1.100 ± 0.030 (27.90 ± 0.76)									
Width	0.300 ± 0.030 (7.62 ± 0.76)							0.400 ± 0.030 (10.20 ± 0.76)							0.500 ± 0.030 (12.70 ± 0.76)									
Thickness Maximum	0.180 (4.57)							0.220 (5.59)							0.220 (5.59)									
Lead Width Maximum	0.200 (5.08)							0.300 (7.62)							0.400 (10.2)									
Lead Length "L"	0.100 ± 0.020 (2.54 ± 0.51)							0.100 ± 0.020 (2.54 ± 0.51)							0.100 ± 0.020 (2.54 ± 0.51)									
Lead Length "J"	0.100 ± 0.020 (2.54 ± 0.51)							0.100 ± 0.020 (2.54 ± 0.51)							0.100 ± 0.020 (2.54 ± 0.51)									
X7R Dielectric																								
Voltage Code	501	102	202	302	402	502	752	501	102	202	302	402	502	752	103	501	102	202	302	402	502	752	103	Capacitance Tolerance
Voltage DC	500	1 K	2 K	3 K	4 K	5 K	7.5 K	500	1 K	2 K	3 K	4 K	5 K	7.5 K	10 K	500	1 K	2 K	3 K	4 K	5 K	7.5 K	10 K	
Capacitance	Capacitance Code																							
820 pF	821	821	821	821	821	821	821																	
1,000 pF	102	102	102	102	102	102	102	102	102	102	102	102	102	102	102									102
1,200 pF	122	122	122	122	122	122	122	122	122	122	122	122	122	122	122									122
1,500 pF	152	152	152	152	152	152	152	152	152	152	152	152	152	152	152									152
1,800 pF	182	182	182	182	182	182	182	182	182	182	182	182	182	182	182									182
2,200 pF	222	222	222	222	222	222	222	222	222	222	222	222	222	222	222									222
2,700 pF	272	272	272	272	272	272	272	272	272	272	272	272	272	272	272									272
3,300 pF	332	332	332	332	332	332	332	332	332	332	332	332	332	332	332	332	332	332	332	332	332	332	332	332
3,900 pF	392	392	392	392	392	392	392	392	392	392	392	392	392	392	392	392	392	392	392	392	392	392	392	392
4,700 pF	472	472	472	472	472	472	472	472	472	472	472	472	472	472	472	472	472	472	472	472	472	472	472	472
5,600 pF	562	562	562	562	562	562	562	562	562	562	562	562	562	562	562	562	562	562	562	562	562	562	562	562
6,800 pF	682	682	682	682	682	682	682	682	682	682	682	682	682	682	682	682	682	682	682	682	682	682	682	682
8,200 pF	822	822	822	822	822			822	822	822	822	822	822	822										822
0.01 µF	103	103	103	103	103			103	103	103	103	103	103	103										103
0.012 µF	123	123	123	123	123			123	123	123	123	123	123	123										123
0.015 µF	153	153	153	153				153	153	153	153	153	153											153
0.018 µF	183	183	183	183				183	183	183	183	183	183											183
0.022 µF	223	223	223	223				223	223	223	223	223	223	223										223
0.027 µF	273	273	273	273				273	273	273	273	273	273											273
0.033 µF	333	333	333	333				333	333	333	333	333												333
0.039 µF	393	393	393	393				393	393	393	393													393
0.047 µF	473	473	473					473	473	473	473													473
0.056 µF	563	563	563					563	563	563	563													563
0.068 µF	683	683	683					683	683	683	683													683
0.082 µF	823	823	823					823	823	823	823													823
0.1 µF	104	104						104	104	104														104
0.12 µF	124	124						124	124	124														124
0.15 µF	154	154						154	154	154														154
0.18 µF	184	184						184	184	184														184
0.22 µF	224	224						224	224	224														224
0.27 µF	274	274						274	274	274														274
0.33 µF	334	334						334	334															334
0.39 µF	394	394						394	394															394
0.47 µF	474	474						474	474															474
0.56 µF	564	564						564	564															564
0.68 µF	684	684						684	684															684
0.82 µF	824							824	824															824
1.0 µF	105							105	105															105
1.2 µF	125							125																125
1.5 µF	155							155																155
1.8 µF								185																185
2.2 µF								225																225
2.7 µF																								275
2.9 µF																								295
3.3 µF																								335
3.9 µF																								395

Table 1D – Capacitance Range/Selection Waterfall SM36 Style/Size

Style/Size	SM36								Capacitance Tolerance
Dimensions – inches (mm)									
Length	1.350 ± 0.030 (33.00 ± 0.76)								K, M, P, Z
Width	0.600 ± 0.030 (15.20 ± 0.76)								
Thickness Maximum	0.220 (5.59)								
Lead Width Maximum	0.500 (12.7)								
Lead Length "L"	0.100 ± 0.020 (2.54 ± 0.51)								
Lead Length "J"	0.100 ± 0.020 (2.54 ± 0.51)								
X7R Dielectric									
Voltage Code	501	102	202	302	402	502	752	103	
Voltage DC	500	1 K	2 K	3 K	4 K	5 K	7.5 K	10 K	
Capacitance	Capacitance Code								K, M, P, Z
1,500 pF								152	
1,800 pF								182	
2,200 pF								222	
2,700 pF								272	
3,300 pF								332	
3,900 pF								392	
4,700 pF	472	472	472	472	472	472	472	472	
5,600 pF	562	562	562	562	562	562	562	562	
6,800 pF	682	682	682	682	682	682	682	682	
8,200 pF	822	822	822	822	822	822	822	822	
0.01 µF	103	103	103	103	103	103	103	103	
0.012 µF	123	123	123	123	123	123	123		
0.015 µF	153	153	153	153	153	153	153		
0.018 µF	183	183	183	183	183	183	183	183	
0.022 µF	223	223	223	223	223	223	223		
0.027 µF	273	273	273	273	273	273			
0.033 µF	333	333	333	333	333	333			
0.039 µF	393	393	393	393	393				
0.047 µF	473	473	473	473	473				
0.056 µF	563	563	563	563	563				
0.068 µF	683	683	683	683	683				
0.082 µF	823	823	823	823					
0.1 µF	104	104	104	104					
0.12 µF	124	124	124	124					
0.15 µF	154	154	154	154					
0.18 µF	184	184	184						
0.22 µF	224	224	224						
0.27 µF	274	274	274						
0.33 µF	334	334	334						
0.39 µF	394	394							
0.47 µF	474	474							
0.56 µF	564	564							
0.68 µF	684	684							
0.82 µF	824	824							
1.0 µF	105	105							
1.2 µF	125	125							
1.5 µF	155	155							
1.8 µF	185	185							
2.2 µF	225	225							
2.7 µF	275								
2.9 µF	295								
3.3 µF	335								
3.9 µF	395								
4.7 µF	475								
5.6 µF	565								

Table 2 – Chip Thickness/Packaging Quantities

Series	Style/Size	Tray Quantity Minimum ¹	Tray Quantity Maximum ¹
SM	SM20	1	50
	SM21		
	SM22		
	SM23		
	SM24		
	SM25		
	SM26		
	SM30		
	SM31		
	SM33		
	SM34		10
	SM35		
	SM36		

¹ Minimum order value applies. Contact KEMET for details.

Soldering Process

The capacitors and assemblies outlined in this specification sheet are susceptible to thermal shock damage due to their large ceramic mass. Temperature profiles used should provide adequate temperature rise and cool-down time to prevent damage from thermal shock. In general, KEMET recommends against hand soldering for these types of large ceramic devices.

Recommended Soldering Technique:

- Solder reflow only

Preheating and Reflow Profile Notes:

Due to differences in the coefficient of thermal expansion for the different materials of construction, it is critical to monitor and control the heating and cooling rates during the soldering process. During the reflow soldering process, the maximum recommended heating and cooling rate (dT/dt) is 4°C/second. To ensure optimal component reliability, KEMET's recommended heating and cooling rate is 2°C/second. After soldering, the capacitors should be air cooled to room temperature before further processing. Forced air cooling is not recommended.

Recommended Reflow Soldering Profile:

Profile Feature	SnPb Assembly
Preheat/Soak	
Temperature Minimum (T_{smin})	100°C
Temperature Maximum (T_{smax})	150°C
Time (t_s) from T_{smin} to T_{smax}	60 – 90 seconds
Ramp-up Rate (T_L to T_p)	2°C/seconds
Liquidous Temperature (T_L)	183°C
Time Above Liquidous (t_L)	95 seconds
Peak Temperature (T_p)	240°C
Time within 5°C of Maximum Peak Temperature (t_p)	5 seconds
Ramp-down Rate (T_p to T_L)	2°C/seconds
Time 25°C to Peak Temperature	3.5 minutes

Note 1: All temperatures refer to the center of the package, measured on the package body surface that is facing up during assembly reflow.

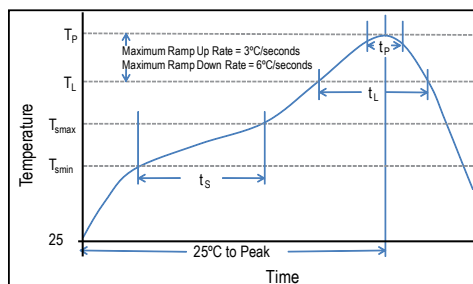

Table 3 – Performance & Reliability: Test Methods and Conditions

Stress	Reference	Test or Inspection Method
Board Flex	JIS-C-6429	Appendix 2, Note: 2 mm (minimum) for all except 3 mm for C0G.
Solderability	J-STD-002	Magnification 50 X. Conditions:
		a) Method B, 4 hours @ 155°C, dry heat @ 235°C
		b) Method B @ 215°C category 3
		c) Method D, category 3 @ 260°C
		1,000 cycles (-55°C to +125°C). Measurement at 24 hours +/- 2 hours after test conclusion.
Biased Humidity	MIL-STD-202 Method 103	Load Humidity: 1,000 hours 85°C/85% RH and 300 VDC Maximum Add 100 K ohm resistor. Measurement at 24 hours +/- 2 hours after test conclusion.
		Low Volt Humidity: 1,000 hours 85°C/85% RH and 1.5 V. Add 100 K ohm resistor. Measurement at 24 hours +/- 2 hours after test conclusion.
		t = 24 hours/cycle. Steps 7a and 7b not required. Unpowered. Measurement at 24 hours +/- 2 hours after test conclusion.
Thermal Shock	MIL-STD-202 Method 107	-55°C/+125°C. Note: Number of cycles required – 300. Maximum transfer time – 20 seconds. D14 dwell time – 15 minutes. Air – Air.
High Temperature Life	MIL-STD-202 Method 108 /EIA -198	1,000 hours at 125°C (85°C for X5R, Z5U and Y5V) with rated voltage applied.
Storage Life	MIL-STD-202 Method 108	150°C, 0 VDC, for 1,000 hours.
Vibration	MIL-STD-202 Method 204	5 g for 20 minutes, 12 cycles each of 3 orientations. Note: Use 8 "X5" PCB 0.031" thick 7 secure points on one long side and 2 secure points at corners of opposite sides. Parts mounted within 2" from any secure point. Test from 10–2,000 Hz.
Resistance to Soldering Heat	MIL-STD-202 Method 210	Condition B. No preheat of samples. Note: single wave solder – procedure 2.
Terminal Strength	MIL-STD-202 Method 211	Conditions A (2.3 kg or 5 lbs).
Mechanical Shock	MIL-STD-202 Method 213	Figure 1 of Method 213, Condition F.
Resistance to Solvents	MIL-STD-202 Method 215	Add aqueous wash chemical, OKEM Clean or equivalent.

Storage and Handling

Ceramic chip capacitors should be stored in normal working environments. While the chips themselves are quite robust in other environments, solderability will be degraded by exposure to high temperatures, high humidity, corrosive atmospheres, and long term storage. In addition, packaging materials will be degraded by high temperature– reels may soften or warp and tape peel force may increase. KEMET recommends that maximum storage temperature not exceed 40°C and maximum storage humidity not exceed 70% relative humidity. Temperature fluctuations should be minimized to avoid condensation on the parts and atmospheres should be free of chlorine and sulfur bearing compounds. For optimized solderability chip stock should be used promptly, preferably within 1.5 years of receipt.

Construction

Reference	Item	Material
A	Leadframe	Phosphor Bronze - Alloy 510 (Silver plated / Nickle Underplate)
B	Leadframe Attach Material	Silver Epoxy
C	MLCC Termination System	Solderable Silver
D		
E		
F	Electrode	PdAg
G	Dielectric	BaTiO ₃

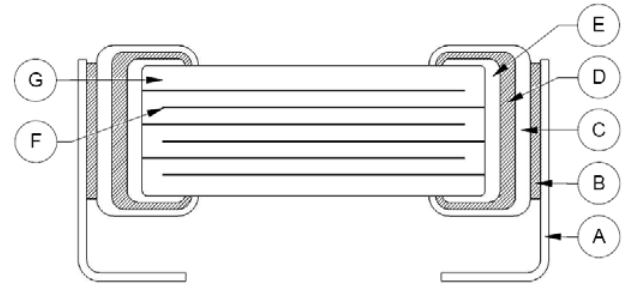

Note: Image is exaggerated in order to clearly identify all components of construction

Product Marking

Product marking is an extra-cost option. These devices will be supplied unmarked unless otherwise specified and/or requested. For more detailed information regarding marked product and how to request this option, please contact KEMET.

Pulse Detonation, High Voltage, High Temperature 200°C, C0G Dielectric, 500 – 2,000 VDC (Industrial Grade)

Overview

KEMET's Industrial Grade Pulse Detonation Series surface mount capacitors in C0G dielectric deliver reliable, high voltage and high temperature performance required for operation in harsh environments, specifically detonation circuitry. Constructed of a robust and proprietary base metal electrode (BME) dielectric system, these devices offer industry-leading performance relative to capacitance and case size. KEMET Pulse Detonation capacitors average greater than 30% higher breakdown voltage than competitive precious metal electrode (PME) devices with similar capacitance and voltage ratings.

Designed for down-hole oil exploration and perforation, these devices feature a 200°C maximum operating temperature. The Electronics Industries Alliance (EIA) characterizes C0G

dielectric as a Class I material. Components of this classification are temperature compensating and are suited for resonant circuit applications or those where Q and stability of capacitance characteristics are required. Pulse Detonation Series capacitors in C0G dielectric exhibit no change in capacitance with respect to time and voltage and boast a negligible change in capacitance with reference to ambient temperature. These devices retain high insulation resistance with low dissipation factor at elevated temperatures up to 200°C.

KEMET's Pulse Detonation surface mount MLCCs are manufactured in state-of-the-art ISO/TS 16949:2002 certified facilities and are proven to function reliably in harsh, high temperature and high humidity down-hole environments.

Benefits

- -55°C to +200°C operating temperature range
- Pb-Free and RoHS Compliant
- Base metal technology
- High breakdown voltage capability up to +200°C
- Higher UVBD capability than competitive dielectric technologies
- Capacitance offerings ranging from 0.5 pF up to 0.15 µF
- Available capacitance tolerances of ±5%, ±10% or ±20%
- Extremely low ESR and ESL
- High thermal stability

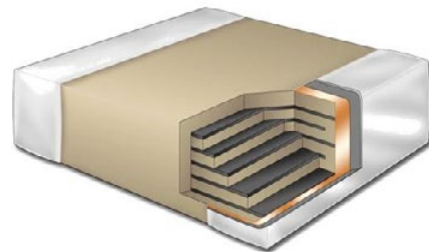

Ordering Information

Contact KEMET for ordering information									
Ceramic	Case Size (L" x W")	Specification/ Series	Capacitance Code (pF)	Capacitance Tolerance	Rated Voltage (VDC) ¹	Dielectric	Failure Rate/ Design	Termination Finish ²	Packaging/Grade (C-Spec) ³
	2824 3040 3640 4040 4540	H= High Temp (200°C)	2 Significant Digits + Number of Zeros	J = ±5% K = ±10% M = ±20%	C = 500 V B = 630 V D = 1,000 V F = 1,500 V G = 2,000 V	G = C0G	W = Pulse Detonation	C = 100% Matte Sn	Contact KEMET for packaging availability and details

¹ For breakdown voltage (UVBD) values see Table 1, Pulse Detonation Series, Capacitance Range Waterfall.

² Additional termination finish options may be available. Contact KEMET for details.

³ Additional reeling or packaging options may be available. Contact KEMET for details.

Dimensions – Millimeters (Inches)

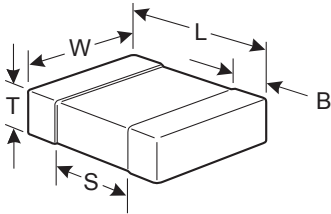

Size Code	L Length	W Width	T Thickness Maximum	B Bandwidth	S Separation Minimum	Mounting Technique
2824	7.10 ± 0.40 (0.280 ± 0.016)	6.10 ± 0.40 (0.240 ± 0.016)	2.5 (0.098)	0.76 ± 0.40 (0.030 ± 0.016)	N/A	Solder Reflow Only
3040	7.60 ± 0.40 (0.300 ± 0.016)	10.20 ± 0.40 (0.402 ± 0.016)				
3640	9.10 ± 0.40 (0.358 ± 0.016)	10.20 ± 0.40 (0.402 ± 0.016)				
4040	10.20 ± 0.40 (0.402 ± 0.016)	10.20 ± 0.40 (0.402 ± 0.016)				
4540	11.40 ± 0.40 (0.449 ± 0.016)	10.20 ± 0.40 (0.402 ± 0.016)				

Benefits

- High ripple current capability
- No capacitance change with respect to applied rated DC voltage
- Negligible capacitance change with respect to temperature from -55°C to +200°C
- No capacitance decay with time
- Non-polar device, minimizing installation concerns
- 100% pure matte tin-plated termination finish allowing for excellent solderability

Applications

Typical applications include high temperature detonation circuits for down-hole oil exploration and perforation.

Qualification/Certification

Industrial Grade pulse detonation products are designed to meet customer-specific testing requirements.

Environmental Compliance

Pb-Free and RoHS Compliant.



RoHS Compliant

Electrical Parameters/Characteristics

Item	Parameters/Characteristics
Operating Temperature Range	-55°C to +200°C
Capacitance Change with Reference to +25°C and 0 VDC Applied (TCC)	±30 ppm/°C
Aging Rate (Maximum % Capacitance Loss/Decade Hour)	0%
Dielectric Withstanding Voltage (DWV)	150% of rated voltage for voltage rating of < 1,000 V 120% of rated voltage for voltage rating of ≥ 1,000 V (5 ±1 seconds and charge/discharge not exceeding 50 mA)
Ultimate Voltage Breakdown (UVBD)	300% of rated voltage for voltage rating of < 1,000 V 250% of rated voltage for voltage rating of 1,000 V 240% of rated voltage for voltage rating of 1,500 V (5 ±1 seconds and charge/discharge not exceeding 50 mA)
Dissipation Factor (DF) Maximum Limit @ 25°C	0.1%
Insulation Resistance (IR) Limit @ 25°C	1000 megohm microfarads or 100 GΩ (500 VDC applied for 120 ±5 seconds @ 25°C)

To obtain IR limit, divide MΩ-μF value by the capacitance and compare to GΩ limit. Select the lower of the two limits.

Capacitance and Dissipation Factor (DF) measured under the following conditions:

1 MHz ±100 kHz and 1.0 Vrms ±0.2 V if capacitance ≤ 1,000 pF

1 kHz ±50 Hz and 1.0 Vrms ±0.2 V if capacitance > 1,000 pF

Note: When measuring capacitance it is important to ensure the set voltage level is held constant. The HP4284 and Agilent E4980 have a feature known as Automatic Level Control (ALC). The ALC feature should be switched to "ON."

Post Environmental Limits

High Temperature Life, Biased Humidity, Moisture Resistance					
Dielectric	Rated DC Voltage	Capacitance Value	Dissipation Factor (Maximum %)	Capacitance Shift	Insulation Resistance
COG	All	All	0.5	0.3% or ±0.25 pF	10% of Initial Limit

Ultimate Voltage Breakdown (UVBD) – Typical Mean Breakdown Voltage Ratings

Rated Voltage (VDC)	Breakdown Voltage/UVBD (VDC)
500	3X Rated
630	3X Rated
1,000	2.5X Rated
1,500	2.3X Rated
2,000	2X Rated

Electrical Characteristics

Current vs. Voltage

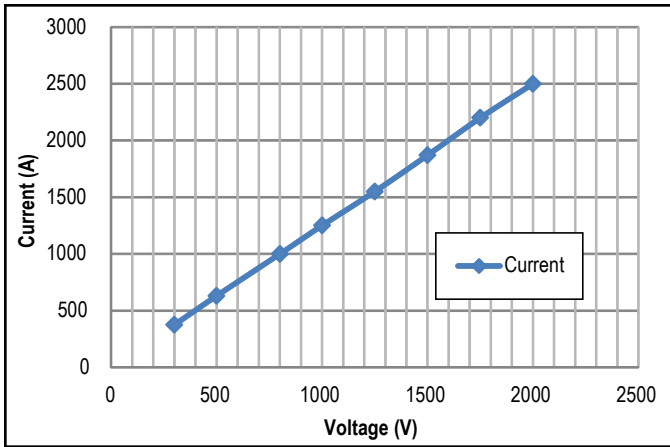

Table 1 – Pulse Detonation Series, Capacitance Range Waterfall

Case Size (in.)		2824					3040					3640					4040					4540									
Length	mm	7.10 ± 0.40					7.60 ± 0.40					9.10 ± 0.40					10.20 ± 0.40					11.40 ± 0.40									
	(in.)	(0.280 ± 0.016)					(0.300 ± 0.016)					(0.358 ± 0.016)					(0.402 ± 0.016)					(0.449 ± 0.016)									
Width	mm	6.10 ± 0.40					10.20 ± 0.40					10.20 ± 0.40					10.20 ± 0.40					10.20 ± 0.40									
	(in.)	(0.240 ± 0.016)					(0.402 ± 0.016)					(0.402 ± 0.016)					(0.402 ± 0.016)					(0.402 ± 0.016)									
Thickness Maximum	mm	2.5					2.5					2.5					2.5					2.5									
	(in.)	(0.098)					(0.098)					(0.098)					(0.098)					(0.098)									
Bandwidth	mm	0.76 ± 0.40					0.76 ± 0.40					0.76 ± 0.40					0.76 ± 0.40					0.76 ± 0.40									
	(in.)	(0.030 ± 0.016)					(0.030 ± 0.016)					(0.030 ± 0.016)					(0.030 ± 0.016)					(0.030 ± 0.016)									
Rated Voltage (VDC)		500	630	1K	1.5K	2K	500	630	1K	1.5K	2K	500	630	1K	1.5K	2K	500	630	1K	1.5K	2K	500	630	1K	1.5K	2K	500	630	1K	1.5K	2K
Voltage Code		C	B	D	F	G	C	B	D	F	G	C	B	D	F	G	C	B	D	F	G	C	B	D	F	G	C	B	D	F	G
Breakdown Voltage (VDC)		1.5K	1.8K	2.5K	3.5K	4K	1.5K	1.8K	2.5K	3.5K	4K	1.5K	1.8K	2.5K	3.5K	4K	1.5K	1.8K	2.5K	3.5K	4K	1.5K	1.8K	2.5K	3.5K	4K	1.5K	1.8K	2.5K	3.5K	4K
Capacitance	Capacitance Tolerance	Capacitance Code (Available Maximum Capacitance)¹																													
5,600pF	J = ±5% K = ±10% M = ±20%					562																									
6,800pF					682																										
8,200pF																103															
0.01µF																															
0.012µF																															
0.015µF															153																
0.018µF																														183	
0.022µF					223																										
0.027µF																															
0.033µF					333																										
0.039µF																															
0.047µF																473															
0.056µF																															
0.062µF																															
0.068µF						683					683																			683	
0.072µF																															
0.082µF																															
0.1µF										104																			104		
0.12µF																															
0.15µF																															
Rated Voltage (VDC)		500	630	1K	1.5K	2K	500	630	1K	1.5K	2K	500	630	1K	1.5K	2K	500	630	1K	1.5K	2K	500	630	1K	1.5K	2K	500	630	1K	1.5K	2K
Voltage Code		C	B	D	F	G	C	B	D	F	G	C	B	D	F	G	C	B	D	F	G	C	B	D	F	G	C	B	D	F	G
Breakdown Voltage (VDC)		1.5K	1.8K	2.5K	3.5K	4K	1.5K	1.8K	2.5K	3.5K	4K	1.5K	1.8K	2.5K	3.5K	4K	1.5K	1.8K	2.5K	3.5K	4K	1.5K	1.8K	2.5K	3.5K	4K	1.5K	1.8K	2.5K	3.5K	4K

¹ Only maximum available CV (capacitance /voltage) values are highlighted. Lower CV values are available upon request. Please contact KEMET to discuss your specific CV requirement.

These products are protected under US Patents 7,172,985 and 7,670,981, other patents pending, and any foreign counterparts.

Table 2 – Chip Capacitor Land Pattern Design Recommendations per IPC–7351

Size Code (in)	Density Level A: Maximum (Most) Land Protrusion (mm)					Density Level B: Median (Nominal) Land Protrusion (mm)					Density Level C: Minimum (Least) Land Protrusion (mm)				
	C	Y	X	V1	V2	C	Y	X	V1	V2	C	Y	X	V1	V2
2824	3.45	1.70	6.60	9.60	7.60	3.35	1.50	6.50	8.70	7.00	3.25	1.30	6.40	8.00	6.70
3040	3.70	1.70	10.70	10.10	11.70	3.60	1.50	10.60	9.20	11.10	3.50	1.30	10.50	8.50	10.80
3640	4.45	1.70	10.70	11.60	11.70	4.35	1.50	10.60	10.70	11.10	4.25	1.30	10.50	10.00	10.80
4040	5.00	1.70	10.70	12.70	11.70	4.90	1.50	10.60	11.80	11.10	4.80	1.30	10.50	11.10	10.80
4540	5.60	1.70	10.70	13.90	11.70	5.50	1.50	10.60	13.00	11.10	5.40	1.30	10.50	12.30	10.80

Density Level A: For low-density product applications. Provides a wider process window for reflow solder processes.

Density Level B: For products with a moderate level of component density. Provides a robust solder attachment condition for reflow solder processes.

Density Level C: For high component density product applications. Before adapting the minimum land pattern variations, the user should perform qualification testing based on the conditions outlined in IPC Standard 7351 (IPC–7351).

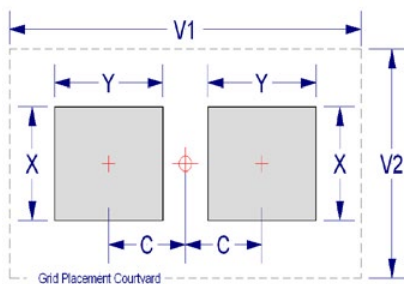

Soldering Process

Recommended Soldering Technique:

- Solder reflow only

Recommended Soldering Profile:

- KEMET recommends following the guidelines outlined in IPC/JEDEC J-STD–020

Storage and Handling

Ceramic chip capacitors should be stored in normal working environments. While the chips themselves are quite robust in other environments, solderability will be degraded by exposure to high temperatures, high humidity, corrosive atmospheres, and long term storage. In addition, packaging materials will be degraded by high temperature— reels may soften or warp and tape peel force may increase. KEMET recommends that maximum storage temperature not exceed 40°C and maximum storage humidity not exceed 70% relative humidity. Temperature fluctuations should be minimized to avoid condensation on the parts and atmospheres should be free of chlorine and sulfur bearing compounds. For optimized solderability chip stock should be used promptly, preferably within 1.5 years of receipt.

Construction

Reference	Item	Material
A	Termination System	Finish
B		Barrier Layer
C		Base Metal
D	Inner Electrode	Ni
E	Dielectric Material	CaZrO ₃

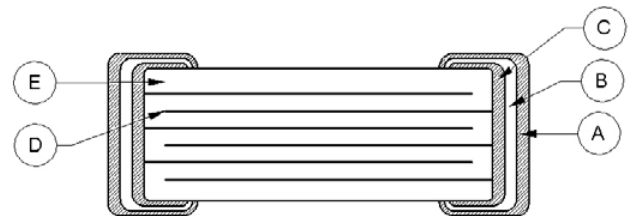

Note: Image is exaggerated in order to clearly identify all components of construction.

Capacitor Marking (Optional):

Laser marking option is not available on:

- COG, Ultra Stable X8R and Y5V dielectric devices
- EIA 0402 case size devices
- EIA 0603 case size devices with Flexible Termination option.
- KPS Commercial and Automotive grade stacked devices.

These capacitors are supplied unmarked only.

Packaging

Please contact KEMET for details regarding available packaging options.

Capacitor Marking (Optional):

These surface mount multilayer ceramic capacitors are normally supplied unmarked. If required, they can be marked as an extra cost option. Marking is available on most KEMET devices but must be requested using the correct ordering code identifier(s). If this option is requested, two sides of the ceramic body will be laser marked with a “K” to identify KEMET, followed by two characters (per EIA-198 - see table below) to identify the capacitance value. EIA 0603 case size devices are limited to the “K” character only.

Marking appears in legible contrast. Illustrated below is an example of an MLCC with laser marking of “KA8”, which designates a KEMET device with rated capacitance of 100 μ F. Orientation of marking is vendor optional.

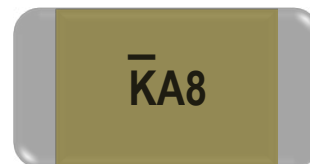

Laser marking option is not available on:

- COG, Ultra Stable X8R and Y5V dielectric devices
- EIA 0402 case size devices
- EIA 0603 case size devices with Flexible Termination option.
- KPS Commercial and Automotive Grade stacked devices.

Capacitance (pF) For Various Alpha/Numeral Identifiers										
Alpha Character	Numeral									
	9	0	1	2	3	4	5	6	7	8
	Capacitance (pF)									
A	0.1	10	10	100	1,000	10,000	100,000	1,000,000	10,000,000	100,000,000
B	0.11	1.1	11	110	1,100	11,000	110,000	1,100,000	11,000,000	110,000,000
C	0.12	12	12	120	1,200	12,000	120,000	1,200,000	12,000,000	120,000,000
D	0.13	13	13	130	1,300	13,000	130,000	1,300,000	13,000,000	130,000,000
E	0.15	15	15	150	1,500	15,000	150,000	1,500,000	15,000,000	150,000,000
F	0.16	16	16	160	1,600	16,000	160,000	1,600,000	16,000,000	160,000,000
G	0.18	18	18	180	1,800	18,000	180,000	1,800,000	18,000,000	180,000,000
H	0.2	20	20	200	2,000	20,000	200,000	2,000,000	20,000,000	200,000,000
J	0.22	22	22	220	2,200	22,000	220,000	2,200,000	22,000,000	220,000,000
K	0.24	24	24	240	2,400	24,000	240,000	2,400,000	24,000,000	240,000,000
L	0.27	27	27	270	2,700	27,000	270,000	2,700,000	27,000,000	270,000,000
M	0.3	30	30	300	3,000	30,000	300,000	3,000,000	30,000,000	300,000,000
N	0.33	33	33	330	3,300	33,000	330,000	3,300,000	33,000,000	330,000,000
P	0.36	36	36	360	3,600	36,000	360,000	3,600,000	36,000,000	360,000,000
Q	0.39	39	39	390	3,900	39,000	390,000	3,900,000	39,000,000	390,000,000
R	0.43	43	43	430	4,300	43,000	430,000	4,300,000	43,000,000	430,000,000
S	0.47	47	47	470	4,700	47,000	470,000	4,700,000	47,000,000	470,000,000
T	0.51	51	51	510	5,100	51,000	510,000	5,100,000	51,000,000	510,000,000
U	0.56	56	56	560	5,600	56,000	560,000	5,600,000	56,000,000	560,000,000
V	0.62	62	62	620	6,200	62,000	620,000	6,200,000	62,000,000	620,000,000
W	0.68	68	68	680	6,800	68,000	680,000	6,800,000	68,000,000	680,000,000
X	0.75	75	75	750	7,500	75,000	750,000	7,500,000	75,000,000	750,000,000
Y	0.82	82	82	820	8,200	82,000	820,000	8,200,000	82,000,000	820,000,000
Z	0.91	91	91	910	9,100	91,000	910,000	9,100,000	91,000,000	910,000,000
a	0.25	25	25	250	2,500	25,000	250,000	2,500,000	25,000,000	250,000,000
b	0.35	35	35	350	3,500	35,000	350,000	3,500,000	35,000,000	350,000,000
d	0.4	40	40	400	4,000	40,000	400,000	4,000,000	40,000,000	400,000,000
e	0.45	45	45	450	4,500	45,000	450,000	4,500,000	45,000,000	450,000,000
f	0.5	50	50	500	5,000	50,000	500,000	5,000,000	50,000,000	500,000,000
m	0.6	60	60	600	6,000	60,000	600,000	6,000,000	60,000,000	600,000,000
n	0.7	70	70	700	7,000	70,000	700,000	7,000,000	70,000,000	700,000,000
t	0.8	80	80	800	8,000	80,000	800,000	8,000,000	80,000,000	800,000,000
y	0.9	90	90	900	9,000	90,000	900,000	9,000,000	90,000,000	900,000,000

Tape & Reel Packaging Information

KEMET offers multilayer ceramic chip capacitors packaged in 8, 12 and 16 mm tape on 7" and 13" reels in accordance with EIA Standard 481. This packaging system is compatible with all tape-fed automatic pick and place systems. See Table 2 for details on reeling quantities for commercial chips.

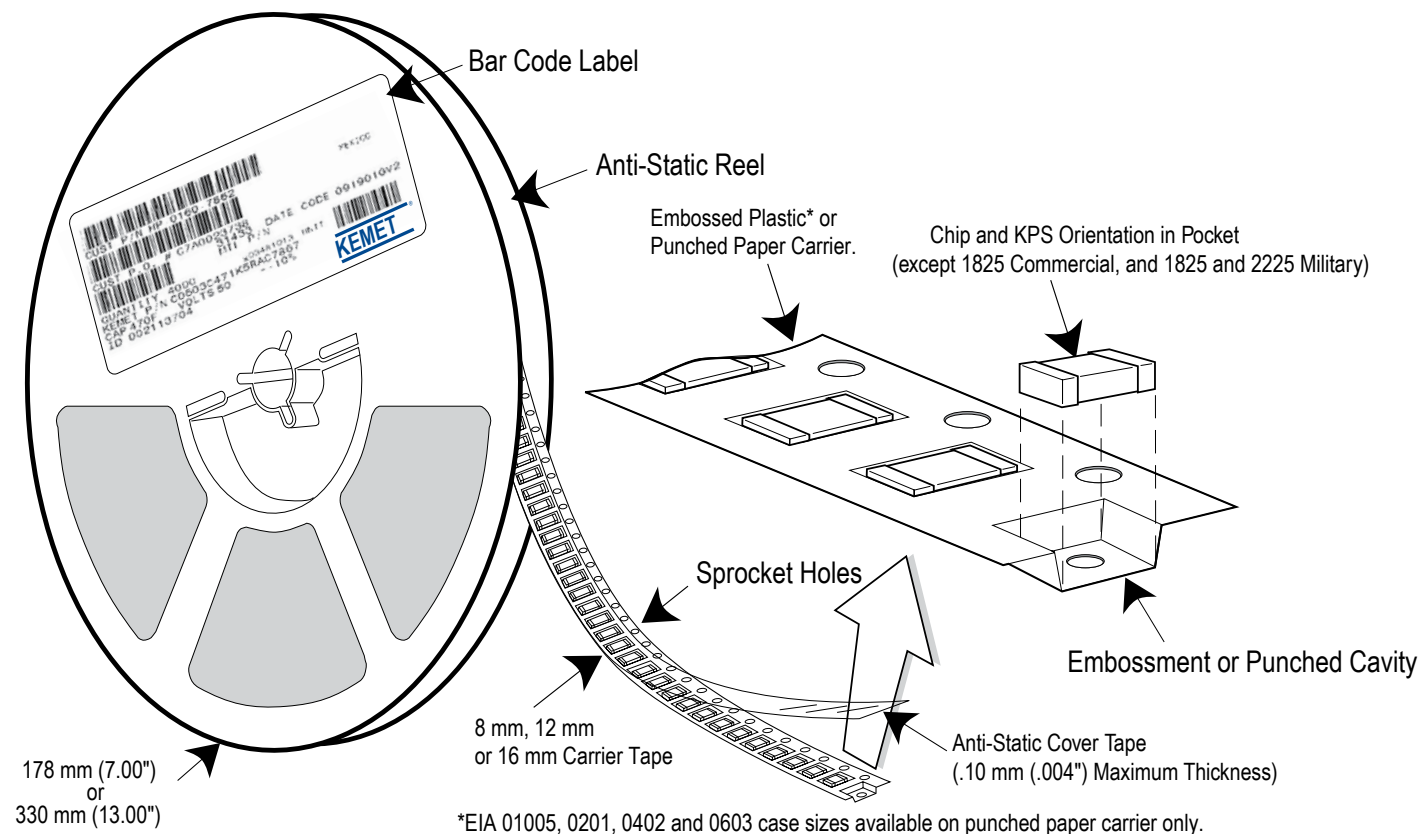

Table 5 – Carrier Tape Configuration – Embossed Plastic & Punched Paper (mm)

EIA Case Size	Tape Size (W)*	Pitch (P ₁)*
01005 – 0402	8	2
0603 – 1210	8	4
1805 – 1808	12	4
≥ 1812	12	8
KPS 1210	12	8
KPS 1812 & 2220	16	12
Array 0508 & 0612	8	4

*Refer to Figures 1 & 2 for W and P₁ carrier tape reference locations.

*Refer to Tables 6 & 7 for tolerance specifications.

Figure 1 – Embossed (Plastic) Carrier Tape Dimensions

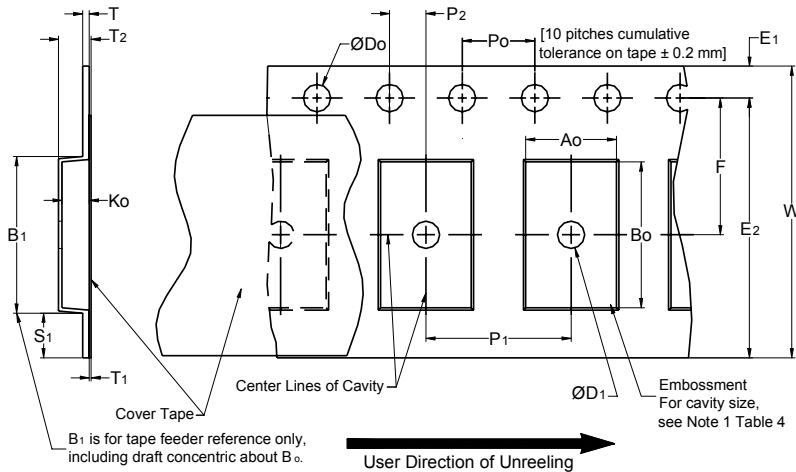

Table 6 – Embossed (Plastic) Carrier Tape Dimensions

Metric will govern

Constant Dimensions — Millimeters (Inches)									
Tape Size	D ₀	D ₁ Minimum Note 1	E ₁	P ₀	P ₂	R Reference Note 2	S ₁ Minimum Note 3	T Maximum	T ₁ Maximum
8 mm	1.5 +0.10/-0.0 (0.059 +0.004/-0.0)	1.0 (0.039)	1.75 ±0.10 (0.069 ±0.004)	4.0 ±0.10 (0.157 ±0.004)	2.0 ±0.05 (0.079 ±0.002)	25.0 (0.984)	0.600 (0.024)	0.600 (0.024)	0.100 (0.004)
12 mm		1.5 (0.059)				30 (1.181)			
16 mm									
Variable Dimensions — Millimeters (Inches)									
Tape Size	Pitch	B ₁ Maximum Note 4	E ₂ Minimum	F	P ₁	T ₂ Maximum	W Maximum	A ₀ , B ₀ & K ₀	
8 mm	Single (4 mm)	4.35 (0.171)	6.25 (0.246)	3.5 ±0.05 (0.138 ±0.002)	4.0 ±0.10 (0.157 ±0.004)	2.5 (0.098)	8.3 (0.327)	Note 5	
12 mm	Single (4 mm) & Double (8 mm)	8.2 (0.323)	10.25 (0.404)	5.5 ±0.05 (0.217 ±0.002)	8.0 ±0.10 (0.315 ±0.004)	4.6 (0.181)	12.3 (0.484)		
16 mm	Triple (12 mm)	12.1 (0.476)	14.25 (0.561)	7.5 ±0.05 (0.138 ±0.002)	12.0 ±0.10 (0.157 ±0.004)	4.6 (0.181)	16.3 (0.642)		

- The embossment hole location shall be measured from the sprocket hole controlling the location of the embossment. Dimensions of embossment location and hole location shall be applied independent of each other.
- The tape with or without components shall pass around R without damage (see Figure 6).
- If S₁ < 1.0 mm, there may not be enough area for cover tape to be properly applied (see EIA Standard 481 paragraph 4.3 section b).
- B₁ dimension is a reference dimension for tape feeder clearance only.
- The cavity defined by A₀, B₀ and K₀ shall surround the component with sufficient clearance that:
 - the component does not protrude above the top surface of the carrier tape.
 - the component can be removed from the cavity in a vertical direction without mechanical restriction, after the top cover tape has been removed.
 - rotation of the component is limited to 20° maximum for 8 and 12 mm tapes and 10° maximum for 16 mm tapes (see Figure 3).
 - lateral movement of the component is restricted to 0.5 mm maximum for 8 and 12 mm wide tape and to 1.0 mm maximum for 16 mm tape (see Figure 4).
 - for KPS Series product, A₀ and B₀ are measured on a plane 0.3 mm above the bottom of the pocket.
 - see Addendum in EIA Standard 481 for standards relating to more precise taping requirements.

Figure 2 – Punched (Paper) Carrier Tape Dimensions

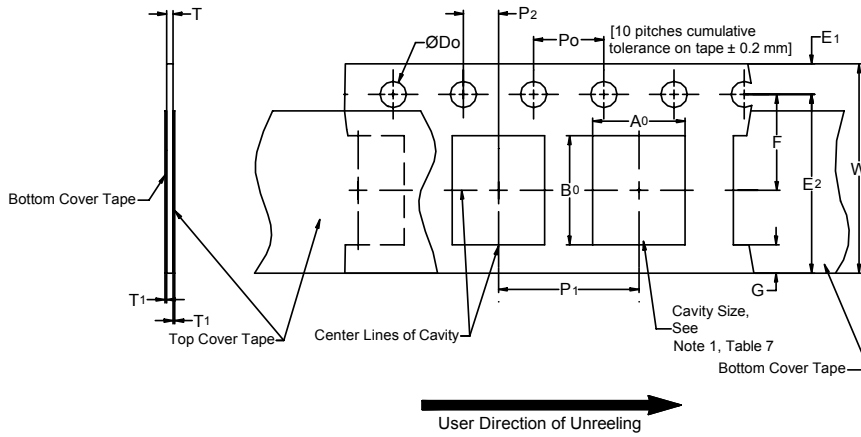

Table 7 – Punched (Paper) Carrier Tape Dimensions

Metric will govern

Constant Dimensions — Millimeters (Inches)							
Tape Size	D_0	E_1	P_0	P_2	T_1 Maximum	G Minimum	R Reference Note 2
8 mm	$1.5 +0.10 -0.0$ (0.059 +0.004 -0.0)	1.75 ± 0.10 (0.069 ±0.004)	4.0 ± 0.10 (0.157 ±0.004)	2.0 ± 0.05 (0.079 ±0.002)	0.10 (0.004) Maximum	0.75 (0.030)	25 (0.984)
Variable Dimensions — Millimeters (Inches)							
Tape Size	Pitch	E2 Minimum	F	P_1	T Maximum	W Maximum	$A_0 B_0$
8 mm	Half (2 mm)	6.25 (0.246)	3.5 ± 0.05 (0.138 ±0.002)	2.0 ± 0.05 (0.079 ±0.002)	1.1 (0.098)	8.3 (0.327)	Note 1
8 mm	Single (4 mm)			4.0 ± 0.10 (0.157 ±0.004)			

- The cavity defined by A_0 , B_0 and T shall surround the component with sufficient clearance that:
 - the component does not protrude beyond either surface of the carrier tape.
 - the component can be removed from the cavity in a vertical direction without mechanical restriction, after the top cover tape has been removed.
 - rotation of the component is limited to 20° maximum (see Figure 3).
 - lateral movement of the component is restricted to 0.5 mm maximum (see Figure 4).
 - see Addendum in EIA Standard 481 for standards relating to more precise taping requirements.
- The tape with or without components shall pass around R without damage (see Figure 6).

Packaging Information Performance Notes

- 1. Cover Tape Break Force:** 1.0 Kg minimum.
- 2. Cover Tape Peel Strength:** The total peel strength of the cover tape from the carrier tape shall be:

Tape Width	Peel Strength
8 mm	0.1 to 1.0 Newton (10 to 100 gf)
12 and 16 mm	0.1 to 1.3 Newton (10 to 130 gf)

The direction of the pull shall be opposite the direction of the carrier tape travel. The pull angle of the carrier tape shall be 165° to 180° from the plane of the carrier tape. During peeling, the carrier and/or cover tape shall be pulled at a velocity of 300 ±10 mm/minute.

- 3. Labeling:** Bar code labeling (standard or custom) shall be on the side of the reel opposite the sprocket holes. Refer to EIA Standards 556 and 624.

Figure 3 – Maximum Component Rotation

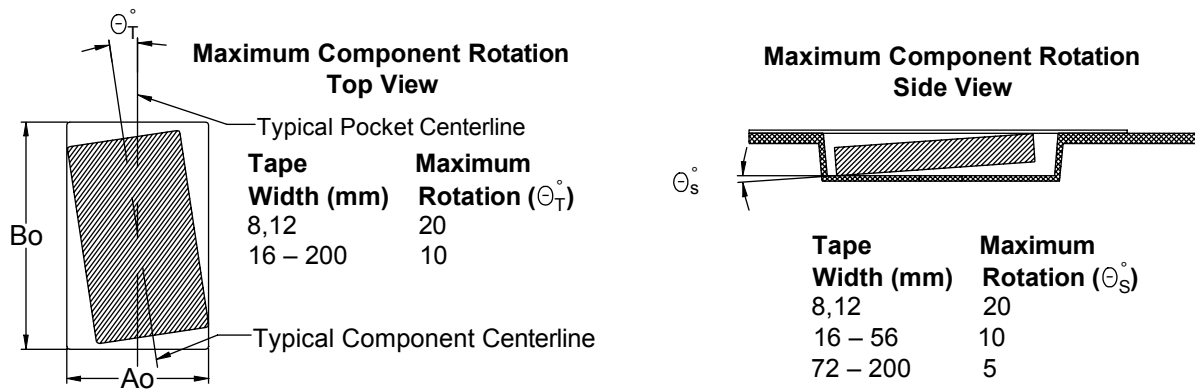

Figure 4 – Maximum Lateral Movement

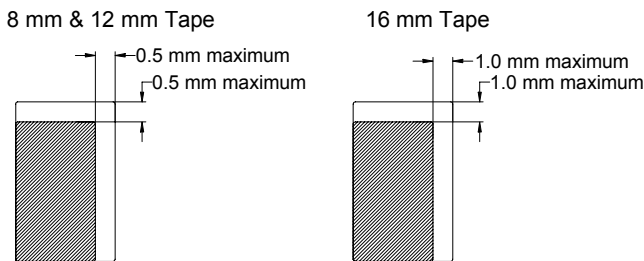

Figure 5 – Bending Radius

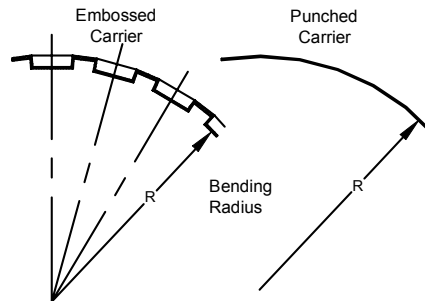
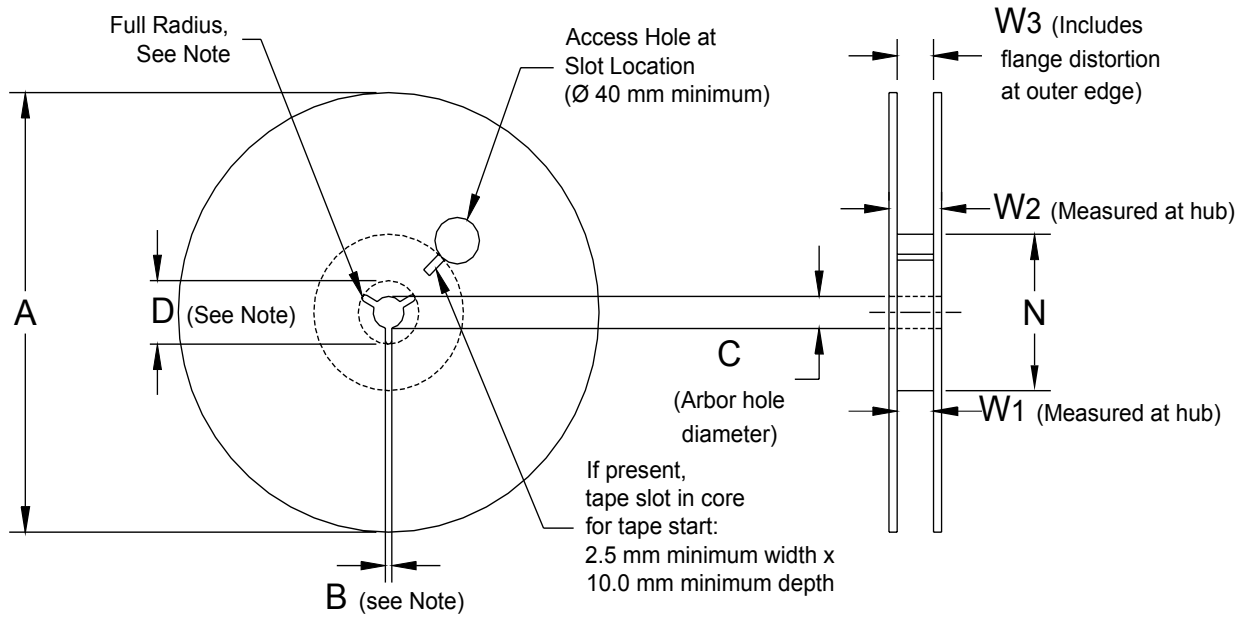

Figure 6 – Reel Dimensions



Note: Drive spokes optional; if used, dimensions B and D shall apply.

Table 8 – Reel Dimensions

Metric will govern

Constant Dimensions — Millimeters (Inches)				
Tape Size	A	B Minimum	C	D Minimum
8 mm	178 ±0.20 (7.008 ±0.008) or 330 ±0.20 (13.000 ±0.008)	1.5 (0.059)	13.0 +0.5/-0.2 (0.521 +0.02/-0.008)	20.2 (0.795)
12 mm				
16 mm				
Variable Dimensions — Millimeters (Inches)				
Tape Size	N Minimum	W ₁	W ₂ Maximum	W ₃
8 mm	50 (1.969)	8.4 +1.5/-0.0 (0.331 +0.059/-0.0)	14.4 (0.567)	Shall accommodate tape width without interference
12 mm		12.4 +2.0/-0.0 (0.488 +0.078/-0.0)	18.4 (0.724)	
16 mm		16.4 +2.0/-0.0 (0.646 +0.078/-0.0)	22.4 (0.882)	

Figure 7 – Tape Leader & Trailer Dimensions

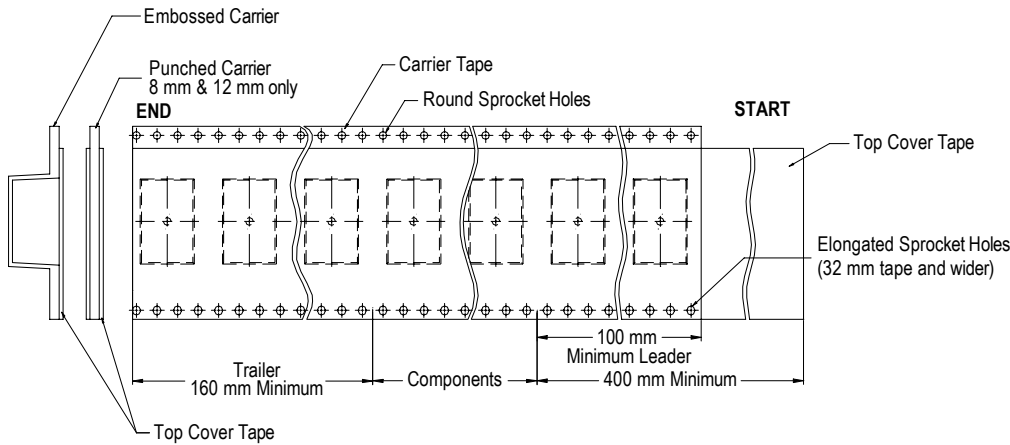
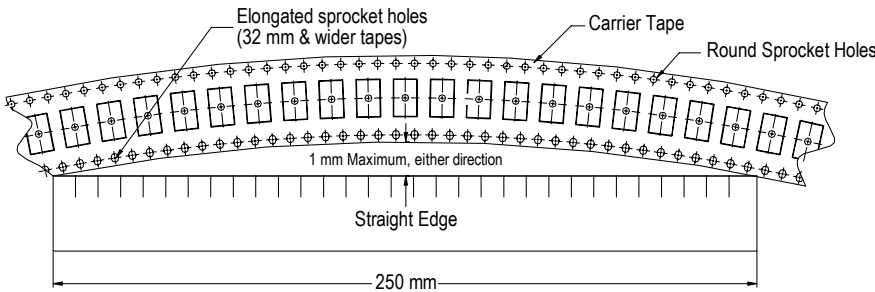

Figure 8 – Maximum Camber



Bulk Cassette Packaging (Ceramic Chips Only)

Meets Dimensional Requirements IEC-286 and EIAJ 7201

Unit mm *Reference

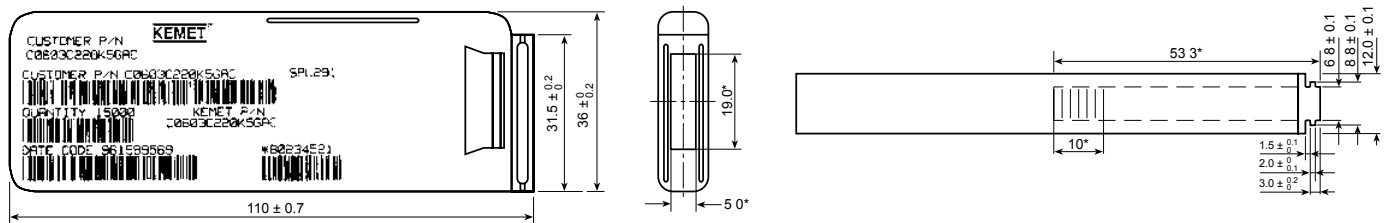

Capacitor Dimensions for Bulk Cassette

Cassette Packaging – Millimeters

EIA Size Code	Metric Size Code	L Length	W Width	B Bandwidth	S Separation Minimum	T Thickness	Number of Pieces/Cassette
0402	1005	1.0 ±0.05	0.5 ±0.05	0.2 to 0.4	0.3	0.5 ±0.05	50,000
0603	1608	1.6 ±0.07	0.8 ±0.07	0.2 to 0.5	0.7	0.8 ±0.07	15,000

Tape & Reel Packaging Information

KEMET offers multilayer ceramic chip capacitors packaged in 8, 12 and 16 mm tape on 7" and 13" reels in accordance with EIA Standard 481. This packaging system is compatible with all tape-fed automatic pick and place systems. See Table 2 for details on reeling quantities for commercial chips.

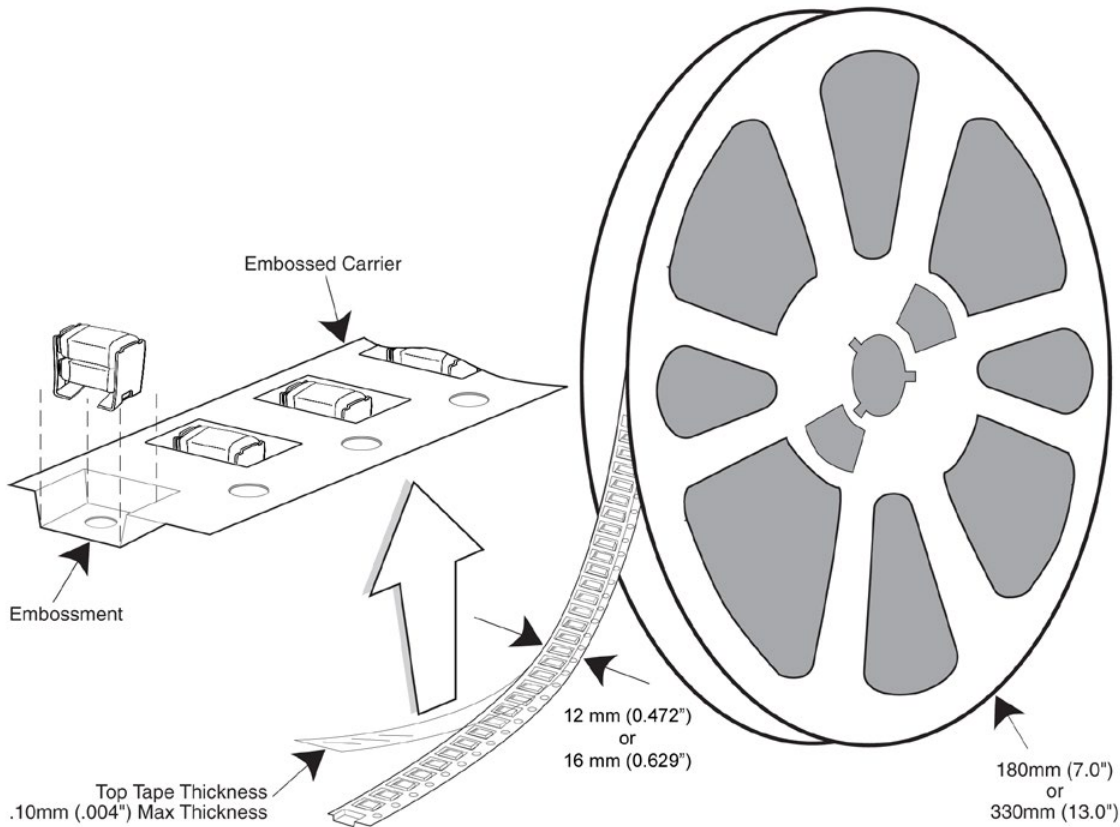

Table 5 – Carrier Tape Configuration – Embossed Plastic (mm)

EIA Case Size	Tape Size (W)*	Pitch (P ₁)*
01005 – 0402	8	2
0603 – 1210	8	4
1805 – 1808	12	4
≥ 1812	12	8
KPS 1210	12	8
KPS 1812 & 2220	16	12
Array 0508 & 0612	8	4

*Refer to Figure 1 for W and P₁ carrier tape reference locations.

*Refer to Table 5 for tolerance specifications.

Figure 1 – Embossed (Plastic) Carrier Tape Dimensions

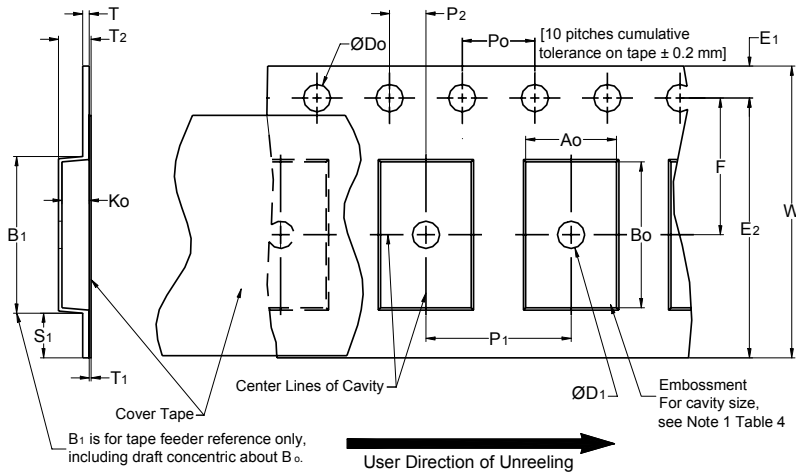

Table 6 – Embossed (Plastic) Carrier Tape Dimensions

Metric will govern

Constant Dimensions — Millimeters (Inches)									
Tape Size	D ₀	D ₁ Minimum Note 1	E ₁	P ₀	P ₂	R Reference Note 2	S ₁ Minimum Note 3	T Maximum	T ₁ Maximum
8 mm	1.5 +0.10/-0.0 (0.059 +0.004/-0.0)	1.0 (0.039)	1.75 ±0.10 (0.069 ±0.004)	4.0 ±0.10 (0.157 ±0.004)	2.0 ±0.05 (0.079 ±0.002)	25.0 (0.984)	0.600 (0.024)	0.600 (0.024)	0.100 (0.004)
12 mm		1.5 (0.059)				30 (1.181)			
16 mm									
Variable Dimensions — Millimeters (Inches)									
Tape Size	Pitch	B ₁ Maximum Note 4	E ₂ Minimum	F	P ₁	T ₂ Maximum	W Maximum	A ₀ , B ₀ & K ₀	
8 mm	Single (4 mm)	4.35 (0.171)	6.25 (0.246)	3.5 ±0.05 (0.138 ±0.002)	4.0 ±0.10 (0.157 ±0.004)	2.5 (0.098)	8.3 (0.327)	Note 5	
12 mm	Single (4 mm) & Double (8 mm)	8.2 (0.323)	10.25 (0.404)	5.5 ±0.05 (0.217 ±0.002)	8.0 ±0.10 (0.315 ±0.004)	4.6 (0.181)	12.3 (0.484)		
16 mm	Triple (12 mm)	12.1 (0.476)	14.25 (0.561)	7.5 ±0.05 (0.138 ±0.002)	12.0 ±0.10 (0.157 ±0.004)	4.6 (0.181)	16.3 (0.642)		

- The embossment hole location shall be measured from the sprocket hole controlling the location of the embossment. Dimensions of embossment location and hole location shall be applied independent of each other.
- The tape with or without components shall pass around R without damage (see Figure 5).
- If S₁ < 1.0 mm, there may not be enough area for cover tape to be properly applied (see EIA Standard 481 paragraph 4.3 section b).
- B₁ dimension is a reference dimension for tape feeder clearance only.
- The cavity defined by A₀, B₀ and K₀ shall surround the component with sufficient clearance that:
 - the component does not protrude above the top surface of the carrier tape.
 - the component can be removed from the cavity in a vertical direction without mechanical restriction, after the top cover tape has been removed.
 - rotation of the component is limited to 20° maximum for 8 and 12 mm tapes and 10° maximum for 16 mm tapes (see Figure 2).
 - lateral movement of the component is restricted to 0.5 mm maximum for 8 and 12 mm wide tape and to 1.0 mm maximum for 16 mm tape (see Figure 3).
 - for KPS Series product, A₀ and B₀ are measured on a plane 0.3 mm above the bottom of the pocket.
 - see Addendum in EIA Standard 481 for standards relating to more precise taping requirements.

Packaging Information Performance Notes

- 1. Cover Tape Break Force:** 1.0 Kg minimum.
- 2. Cover Tape Peel Strength:** The total peel strength of the cover tape from the carrier tape shall be:

Tape Width	Peel Strength
8 mm	0.1 to 1.0 Newton (10 to 100 gf)
12 and 16 mm	0.1 to 1.3 Newton (10 to 130 gf)

The direction of the pull shall be opposite the direction of the carrier tape travel. The pull angle of the carrier tape shall be 165° to 180° from the plane of the carrier tape. During peeling, the carrier and/or cover tape shall be pulled at a velocity of 300 ±10 mm/minute.

- 3. Labeling:** Bar code labeling (standard or custom) shall be on the side of the reel opposite the sprocket holes. Refer to EIA Standards 556 and 624.

Figure 2 – Maximum Component Rotation

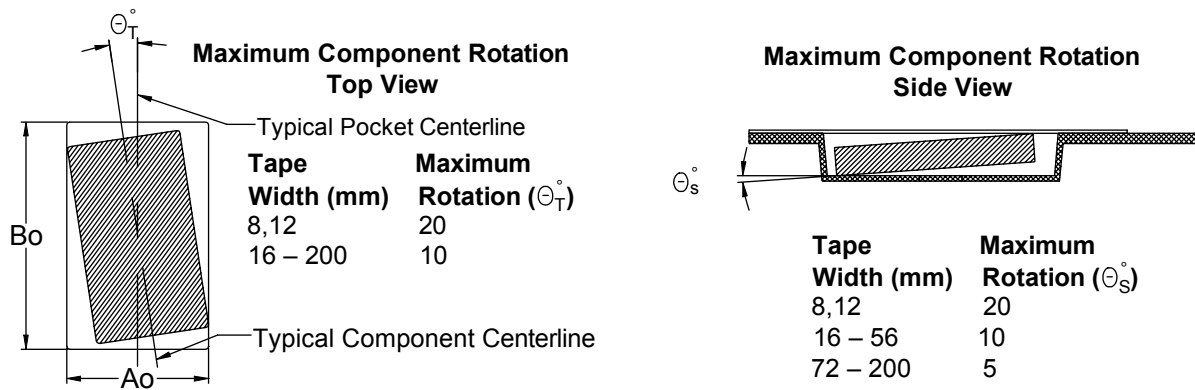

Figure 3 – Maximum Lateral Movement

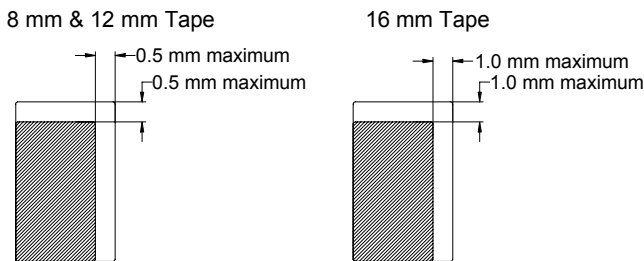

Figure 4 – Bending Radius

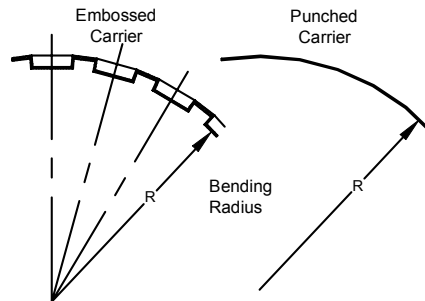
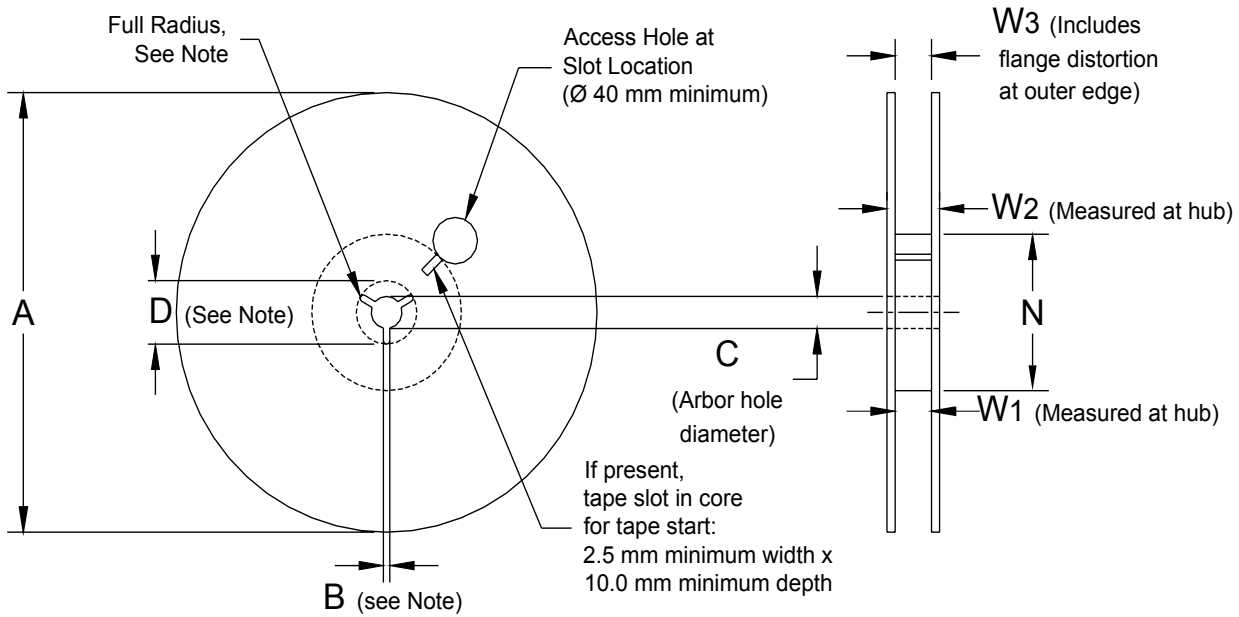

Figure 5 – Reel Dimensions



Note: Drive spokes optional; if used, dimensions B and D shall apply.

Table 7 – Reel Dimensions

Metric will govern

Constant Dimensions — Millimeters (Inches)				
Tape Size	A	B Minimum	C	D Minimum
8 mm	178 ±0.20 (7.008 ±0.008) or 330 ±0.20 (13.000 ±0.008)	1.5 (0.059)	13.0 +0.5/-0.2 (0.521 +0.02/-0.008)	20.2 (0.795)
12 mm				
16 mm				
Variable Dimensions — Millimeters (Inches)				
Tape Size	N Minimum	W ₁	W ₂ Maximum	W ₃
8 mm	50 (1.969)	8.4 +1.5/-0.0 (0.331 +0.059/-0.0)	14.4 (0.567)	Shall accommodate tape width without interference
12 mm		12.4 +2.0/-0.0 (0.488 +0.078/-0.0)	18.4 (0.724)	
16 mm		16.4 +2.0/-0.0 (0.646 +0.078/-0.0)	22.4 (0.882)	

Figure 6 – Tape Leader & Trailer Dimensions

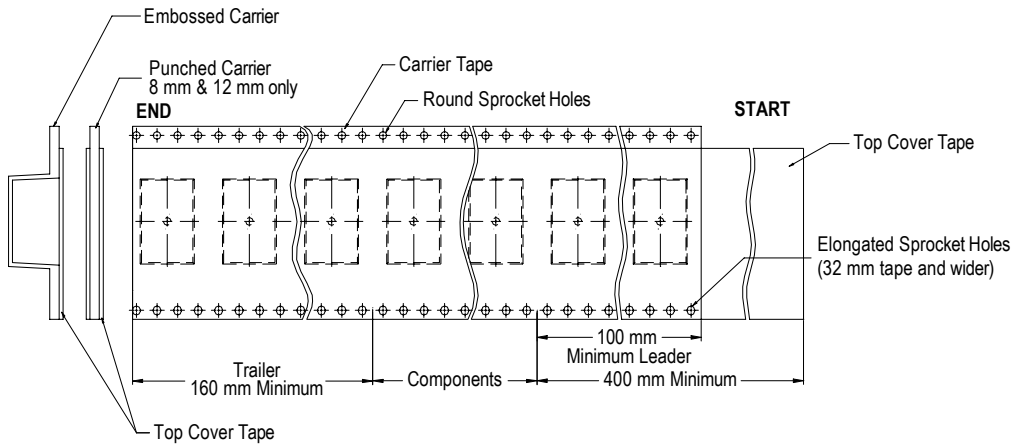
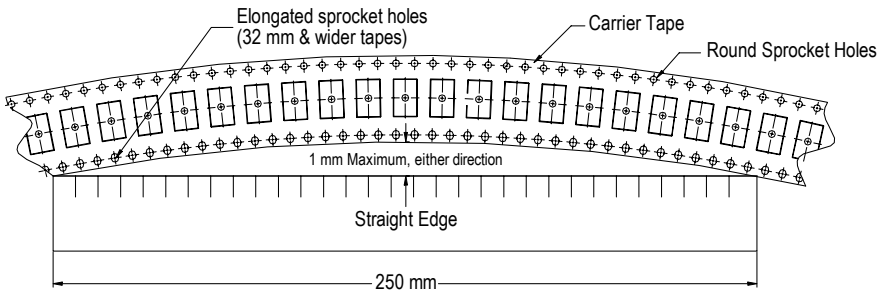

Figure 7 – Maximum Camber



KEMET Corporation World Headquarters

2835 KEMET Way
Simpsonville, SC 29681

Mailing Address:
P.O. Box 5928
Greenville, SC 29606

www.kemet.com
Tel: 864-963-6300
Fax: 864-963-6521

Corporate Offices
Fort Lauderdale, FL
Tel: 954-766-2800

North America

Southeast
Lake Mary, FL
Tel: 407-855-8886

Northeast
Wilmington, MA
Tel: 978-658-1663

Central
Novi, MI
Tel: 248-994-1030

West
Milpitas, CA
Tel: 408-433-9950

Mexico
Guadalajara, Jalisco
Tel: 52-33-3123-2141

Europe

Southern Europe
Paris, France
Tel: 33-1-4646-1006

Sasso Marconi, Italy
Tel: 39-051-939111

Central Europe
Landsberg, Germany
Tel: 49-8191-3350800

Kamen, Germany
Tel: 49-2307-438110

Northern Europe
Bishop's Stortford, United Kingdom
Tel: 44-1279-460122

Espoo, Finland
Tel: 358-9-5406-5000

Asia

Northeast Asia
Hong Kong
Tel: 852-2305-1168

Shenzhen, China
Tel: 86-755-2518-1306

Beijing, China
Tel: 86-10-5829-1711

Shanghai, China
Tel: 86-21-6447-0707

Taipei, Taiwan
Tel: 886-2-27528585

Southeast Asia
Singapore
Tel: 65-6586-1900

Penang, Malaysia
Tel: 60-4-6430200

Bangalore, India
Tel: 91-806-53-76817

Note: KEMET reserves the right to modify minor details of internal and external construction at any time in the interest of product improvement. KEMET does not assume any responsibility for infringement that might result from the use of KEMET Capacitors in potential circuit designs. KEMET is a registered trademark of KEMET Electronics Corporation.

Other KEMET Resources

Tools	
Resource	Location
Configure A Part: CapEdge	http://capacitoredge.kemet.com
SPICE & FIT Software	http://www.kemet.com/spice
Search Our FAQs: KnowledgeEdge	http://www.kemet.com/keask
Electrolytic LifeCalculator	http://www.kemet.com:8080/elc

Product Information	
Resource	Location
Products	http://www.kemet.com/products
Technical Resources (Including Soldering Techniques)	http://www.kemet.com/technicalpapers
RoHS Statement	http://www.kemet.com/rohs
Quality Documents	http://www.kemet.com/qualitydocuments

Product Request	
Resource	Location
Sample Request	http://www.kemet.com/sample
Engineering Kit Request	http://www.kemet.com/kits

Contact	
Resource	Location
Website	www.kemet.com
Contact Us	http://www.kemet.com/contact
Investor Relations	http://www.kemet.com/ir
Call Us	1-877-MyKEMET
Twitter	http://twitter.com/kemetcapacitors

Disclaimer

All product specifications, statements, information and data (collectively, the "Information") in this datasheet are subject to change. The customer is responsible for checking and verifying the extent to which the Information contained in this publication is applicable to an order at the time the order is placed.

All Information given herein is believed to be accurate and reliable, but it is presented without guarantee, warranty, or responsibility of any kind, expressed or implied.

Statements of suitability for certain applications are based on KEMET Electronics Corporation's ("KEMET") knowledge of typical operating conditions for such applications, but are not intended to constitute – and KEMET specifically disclaims – any warranty concerning suitability for a specific customer application or use. The Information is intended for use only by customers who have the requisite experience and capability to determine the correct products for their application. Any technical advice inferred from this Information or otherwise provided by KEMET with reference to the use of KEMET's products is given gratis, and KEMET assumes no obligation or liability for the advice given or results obtained.

Although KEMET designs and manufactures its products to the most stringent quality and safety standards, given the current state of the art, isolated component failures may still occur. Accordingly, customer applications which require a high degree of reliability or safety should employ suitable designs or other safeguards (such as installation of protective circuitry or redundancies) in order to ensure that the failure of an electrical component does not result in a risk of personal injury or property damage.

Although all product-related warnings, cautions and notes must be observed, the customer should not assume that all safety measures are indicated or that other measures may not be required.

Product & Process Design

Sales & Marketing

Supplier

Material Management

Quality

Manufacturing

Logistics & Distribution

People: Leadership
& Development

KEMET Production System

Corporate Offices

KEMET Corporation
2835 KEMET Way
Simpsonville, SC 29681
USA
Tel: 864.963.6300
Fax: 864.963.6521

KEMET Electronics GmbH
Rudolf-Diesel-Straße 21
86899 Landsberg
Germany
Tel: +49 8191 3350 ext. 0
Fax: 49 8191 335063

KEMET Electronics Marketing (S) Pte Ltd.
73 Bukit Timah Road
#05-01 Rex House
Singapore 229832
Tel: 65.6586.1900
Fax: 65.6586.1901

www.kemet.com

One world. One KEMET.

Electronic Components
KEMET
CHARGED®